



**EA1400 / EA1600**  
**Analog Class-D Amplifier**  
**Installation and User Manual**

# Contents

<b>1</b>	<b>Introduction</b>	<b>3</b>
1.1.	Document Scope	3
1.2.	Product Information	3
1.3.	Publication Log	3
1.4.	Rules & Regulations	3
<b>2</b>	<b>Connectors and Controls</b>	<b>4</b>
2.1.	Cabinet	4
2.2.	Power	4
2.3.	Audio Input	5
2.4.	Audio Control	5
2.5.	Loudspeaker Outputs	6
2.6.	Fault Relay	6
2.7.	Settings Switch	7
2.8.	Control In/Out (optional)	7
2.9.	Indicators	8
<b>3</b>	<b>Installation &amp; Wiring</b>	<b>9</b>
3.1.	Unpacking	9
3.2.	Mounting	9
3.3.	Cable Layout	9
3.4.	Mains Power and Grounding	9
3.5.	Input Connection	10
3.6.	Loudspeaker Connections	11
3.7.	Practical Usage with Calculation Example	11
3.8.	Optional Connections	12
<b>4</b>	<b>Startup &amp; System Check</b>	<b>14</b>
4.1.	Preparations	14
4.2.	Sound	14
4.3.	Setting Maximum Output Voltage and Power Using a 1 kHz Source	14
4.4.	Line Monitoring	14
<b>5</b>	<b>Service</b>	<b>15</b>
5.1.	Service Information	15
5.2.	Fuse Replacement	15
<b>6</b>	<b>EA1400 / EA1600 Dimensions</b>	<b>16</b>

---

# 1 Introduction

## 1.1. Document Scope

This document is intended to provide relevant information on the amplifier features, typical configuration, basic installation and wiring of the EA1400 and EA1600 amplifier. See product datasheet for technical details.

## 1.2. Product Information

Item No.	Item Name	Description
1023121400	EA1400	Exigo Amplifier 1 x 400W
1023131600	EA1600	Exigo Amplifier 1 x 600W

## 1.3. Publication Log

Revision	Date	Author	Status/Comments
1.0	6.3.2020	LK/HKL	Published

## 1.4. Rules & Regulations

The EA1400 & EA1600 amplifier and its components have been tested according to the following regulation:

- **EN 60945: Fourth edition, 2002**

"Maritime navigation and radio communication equipment and systems - General requirements - Methods of testing and required test results".

## 2 Connectors and Controls

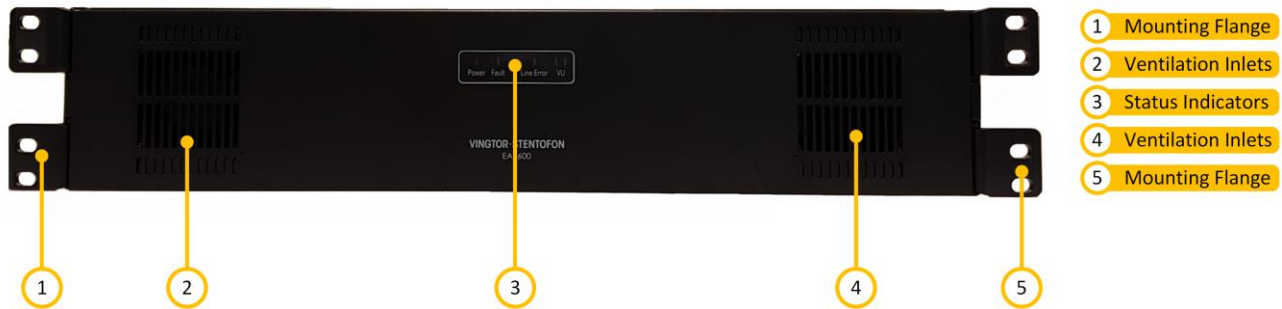

Figure 1: Amplifier Front Panel

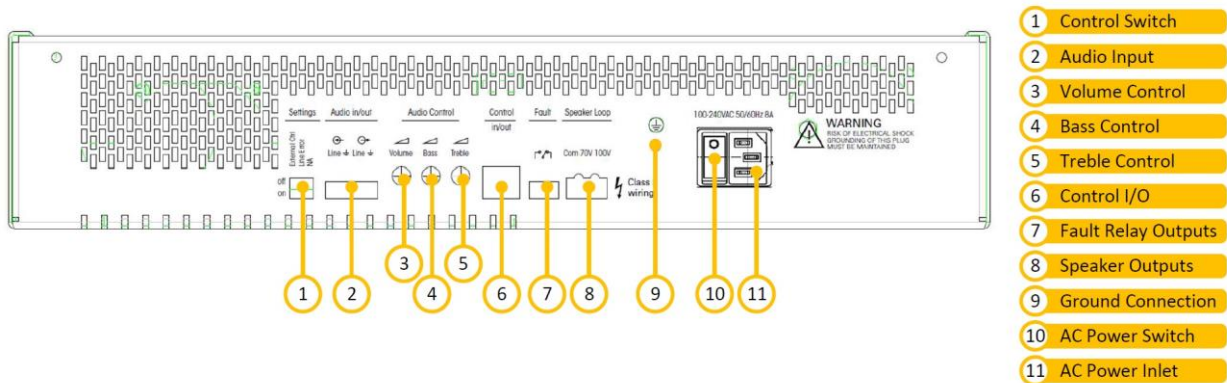

Figure 2: Amplifier Rear Panel

### 2.1. Cabinet

The amplifier is prepared for mounting in a standard 19" rack and will occupy 2HU in height. The amplifier can also be free-standing on a level, open surface. The amplifier has a built-in cooling fan but the front and back must be kept free of objects in order to secure sufficient air flow.

### 2.2. Power

100-240VAC 50/60Hz 8A

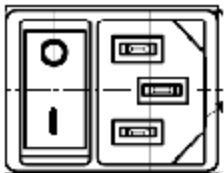

The amplifier is powered by 100-240 VAC 50/60 Hz mains. There is a mains circuit breaker on the cabinet rear side, and a mains fuse on the Main Board inside the cabinet. The fuse value is 8A. The amplifier must be grounded with the main cable, or with a 2.5 mm<sup>2</sup> wire between the amplifier's ground terminal and a proven good PE grounding point.

---

## 2.3. Audio Input



This connector is used as a line input and output with a 6-pin Phoenix MiniCombi connector:

- Pin#1 & Pin#2: Balanced Line IN audio input for public announcements, alarm messages, background music, etc.
- Pin#3: Line IN audio cable shielding; connected to chassis ground.
- Pin#4 & Pin#5: Balanced Line OUT for output daisy chaining of audio signal. It is dependent on the source impedance how many amplifiers can be driven with the same audio signal. Using a low impedance source, it is possible to drive 5 amplifiers or more with this daisy-chain method.
- Pin#6: Line OUT audio cable shielding; connected to chassis ground.

For more information and application example, please refer to section **3.5. Input Connection**.

## 2.4. Audio Control



Volume adjustment can be done through the potentiometers for Volume, Bass, and Treble. If the Volume potentiometer is set to the mid-point position and 1Vrms/1kHz is used as input signal, 100Vrms should be measured on the "100V" loudspeaker output.

For Volume, the control range is between -14dB and +6dB.

For Bass and Treble, the control range is between 0dB and -10dB.

---

## 2.5. Loudspeaker Outputs

The loudspeaker outputs have a 3-pin Phoenix 5.08 mm connector:

- Speaker Loop: full power output available on the 100V or 70V constant voltage line
- Max. cable cross section: 12 AWG / 2.5 mm<sup>2</sup>

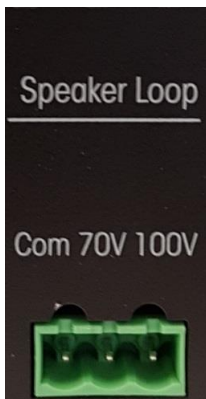

For more information and application example, please refer to section **3.6. Loudspeaker Connections**.

## 2.6. Fault Relay

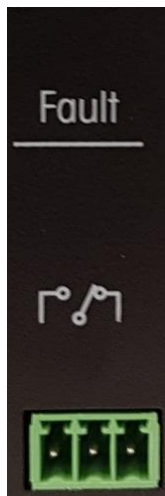

- Fault Relay: NO/NC contacts of a built-in relay is available for remote warning devices. The relay is activated during various fault conditions such as shorted speaker lines, ground fault, overtemperature or overload on audio output.

For more information and application example, please refer to section **3.8. Optional Connections**.

---

## 2.7. Settings Switch

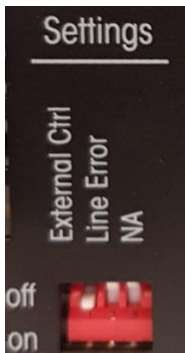

**External Ctrl: NOT IN USE**

### Line Error

- **ON: Line monitoring enabled** A 21-kHz pilot tone signal (not hearable) will be delivered to the outputs continuously to detect short circuit or ground fault events on the audio outputs lines. Its amplitude is between 6V..10Vrms on the outputs, dependent on the load. (No load = 10Vrms, @17Ω is about 6V)
- **OFF: Line monitoring disabled**

**NA: NOT IN USE**

## 2.8. Control In/Out (optional)



The RJ45 connector is for remote control and monitoring (without any network capabilities)

For more information and application example, please refer to section **3.8. Optional Connections**.

---

## 2.9. Indicators



### Power

- A green LED is lit when the amplifier is powered

### Fault

A yellow warning LED will be lit if any of these events have occurred:

- Too high temperature
- Overload on audio output
- Ground fault or short circuit on output (Only if line monitoring is enabled)
- Too high audio input signal ( $>1.5V_{rms}$ )
- Internal fault

### Line Error

- A yellow warning LED will be lit by ground fault or short circuit on output. (Only if the line monitor function is enabled).

### VU meter

- Green and red LEDs indicate the output level from -18 dB to +1 dB. When it goes over 0dB, clipping will be activated, and the red LED will be lit.



## 3 Installation & Wiring

### 3.1. Unpacking

In addition to the amplifier, 3 pieces mounting plugs (for Audio Input, Audio Output and Fault Relay) are included in the delivery.

### 3.2. Mounting

The amplifier is prepared for mounting in a rack with a standard width of 483 mm (19") and 89 mm (2 HU - 3½") vertical space.

Rack Temperature: -15°C to +55°C

Zenitel recommends installing the amplifier in a ventilated technical instrument room with temperatures between +18°C to +25°C. This will also extend the life span of the system. If operated in higher temperatures, the output RMS power may be degraded by <2dB after a period of continuous operation.

Humidity: <95% RH

Compass Safe Distance: >145 cm

AC power outlet with provision for grounding.

Forced cooling may be needed to avoid overheating of the rack.

#### **WARNING**

*Failure to observe the above precautions could result in overheating that could damage the equipment or create a fire hazard.*

### 3.3. Cable Layout

- Do not run the installation cable from microphone and alarm panels parallel to, or too near the cables for loudspeakers or power cables.
- The shields must be interconnected in junction boxes and grounded in the amplifier unit only. It is good practice to have separate conductors for each type of signal cabling.
- Two-conductor shielded cable is required for the microphone.

### 3.4. Mains Power and Grounding

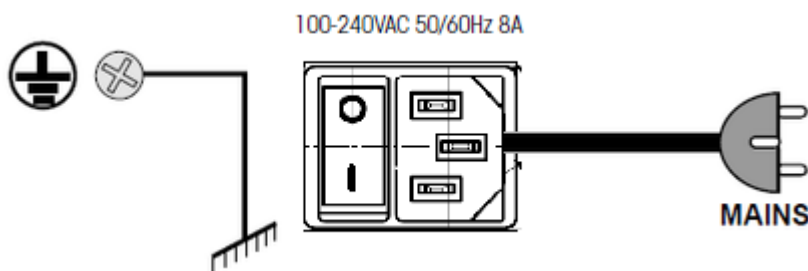

#### **WARNING**

Do NOT connect AC power to the amplifier until all the necessary input and output connections have been completed. Use a dedicated single-phase power input that adheres to the following recommendations:

- 100..240 VAC, 50-60 Hz, fused and capable of delivering a maximum of 8A .
- The operating power should be wired and fused independently from all other inputs.
- A warning tag should be attached to circuit-breaker-type fuses to prevent unauthorized manual operation.
- The mains power cable should be 3 x 1 mm<sup>2</sup> rated for 500 VAC.



### 3.6. Loudspeaker Connections

There are two possibilities of connecting several loudspeakers: Either the 100V output or 70V output as shown below:

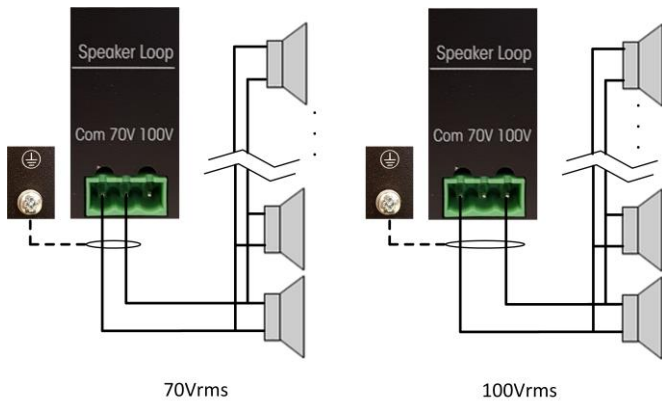

Type	EA1400		EA1600	
	Output	70Vrms	100Vrms	70Vrms
Loudspeakers' Impedance	12.5Ω @400W	25Ω @400W	8.4Ω @600W	16.7Ω @600W

### 3.7. Practical Usage with Calculation Example

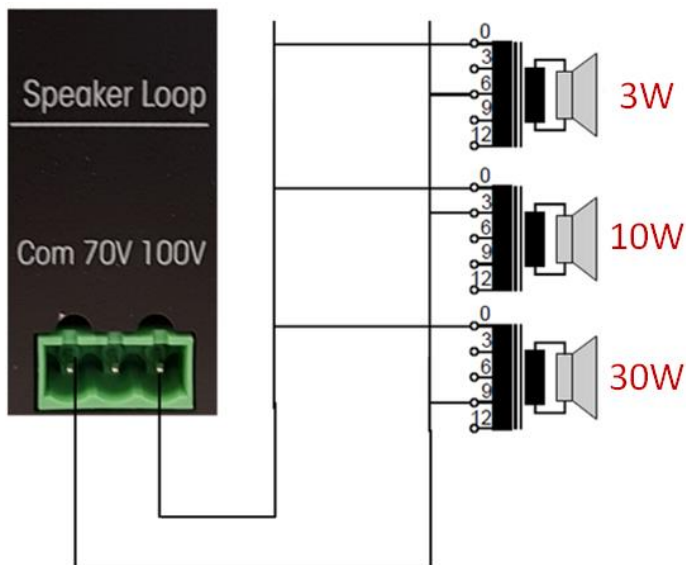

The 100V / 70V system is used when a large number of speakers are installed and/or the speakers are placed far from the amplifier. Speakers with a line-matching transformer designed for constant voltage lines must be used.

---

The speakers must be connected in parallel. The impedance taps on the primary of the line transformers determine the power taken from the line. One or more speakers may be removed or added without affecting the rest of the system.

Speakers are added as needed until the total wattage absorbed by the line transformers is equal to the rated output power of the amplifier. It is good practice to give a power headroom of 10% - 20%, i.e. a speaker load of 500W on a 600W amplifier.

**Example:**

To calculate the maximum number of 30W speakers on a 600W amplifier:

$$\text{Number of speakers} = \text{Amplifier power} / \text{Speaker power} = 600/30 = 20$$

### 3.8. Optional Connections

#### Fault Relay



- Connect one wire from an external warning device to the FAULT RELAY terminal marked COM.
- Insert a suitable power supply between the other device wire and the NC terminal.

The relay contacts can switch up to 1 A at 24 VDC.

#### EXT I/O Control

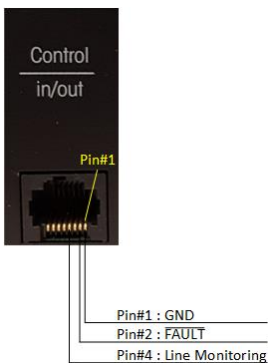

---

The EXT I/O control is a RJ45 connector (without any network capabilities) with the following functions:

- **GND** (Pin#1): Internal 0V
- **FAULT** (Pin#2): Output for fault signals. External device can get a warning if Class-D circuit has been stopped – if over temperature or overload error event has occurred.
- **Line Monitoring** (Pin#4): Input for remote control of line monitoring. It can be enabled by applying “HIGH” level to Pin#4 and disabled by applying “LOW” level to Pin#4.

+3.3V levels are used as control signal. “HIGH” level is 3.3V and “LOW” level is 0V.

**Recommended positions for Settings Switch when using external control:**

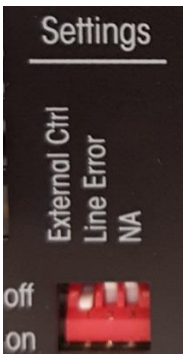

- External Ctrl: **NOT IN USE** so ON or OFF is valid
- Line Error: **ON**
- NA: **NOT IN USE** so ON or OFF is valid

---

## 4 Startup & System Check

### 4.1. Preparations

- All wiring and connections should be finished.
- Turn all volume controls down to the minimum position (counter-clockwise).
- Connect the power cord to the mains outlet.
- Turn the mains switch ON and check that the Power LED is on. Fault and Line Error LEDs may blink shortly at the beginning, but it should not be lit continuously.
- None of the VU meter LEDs should be lit.

### 4.2. Sound

- A signal source must be connected to the Line In input (0.5-1.5Vrms).
- Turn the signal source on and set the amplifier volume- and tone controls to the mid position.
- Adjust the source volume to the appropriate level.
- Check that all loudspeakers connected to the Speaker Loop output (70V or 100V) are sounding without distortion.
- The VU meter should indicate with a pulsating green light.
- The PA amplifier has a mute control, which means that if no input signal is present, then Audio Line input will be muted.

### 4.3. Setting Maximum Output Voltage and Power Using a 1 kHz Source

To achieve 100Vrms level without overloading/clipping, the following procedure is recommended:

- Turn the amplifier volume control slowly clockwise until the red VU Meter LED lights up. The green VU Meter LED shall become brighter during this process.
- Turn the volume control slowly counterclockwise a little at a time until the VU Meter's red LED extinguishes.
- Setting of Treble/Bass can affect clipping detection. If this phenomenon occurs, it should be adjusted with the volume potentiometer.
- If Line Monitoring is enabled, its amplitude will be added to the main signal. If the clipping level is exceeded, it should be adjusted with the volume potentiometer by reducing the amplitude.

### 4.4. Line Monitoring

The Line Error switch on the rear side of the cabinet should be ON to enable line monitoring.

**Line Error switch ON:** Line Monitoring functions are enabled.

**Line Error switch OFF:** Line Monitoring functions are disabled, and there is no line error detection.

The Line Monitoring function can be used permanently (if it is always enabled) or temporarily to test loudspeaker loops only by service interval. Remote control for temporary or periodical use is preferred. For more information regarding external control, please refer to section **3.8. Optional Connections**.

---

## 5 Service

### 5.1. Service Information

All service on this unit should be performed by qualified service technicians only.

- Contact your local Vingtor-Stentofon dealer or representative for service.

#### **WARNING!**

**Always disconnect the mains power cable before opening the cabinet to avoid electrical shock hazard and possible damage to the equipment.**

### 5.2. Fuse Replacement

#### Mains Voltage Protection

There is one replaceable fuse:

- **F1** on the Main Board near the mains inlet inside the cabinet

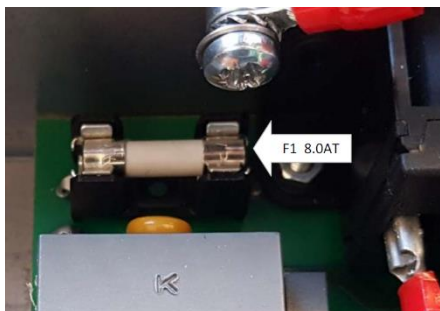

A blown fuse normally indicates a malfunction of the amplifier or a short term overload.

**Always replace with fuses of same type (Littelfuse 0215008.TXP or Schurter 34.3126) and value (8AT). On recurring fuse blows, contact qualified service personnel.**

## 6 EA1400 / EA1600 Dimensions

FRONT VIEW

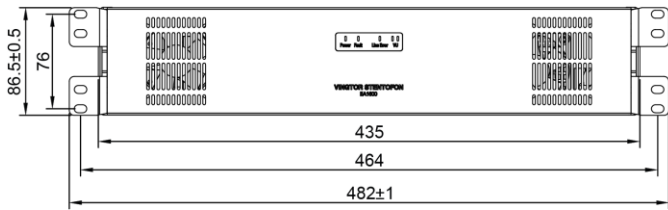

TOP VIEW

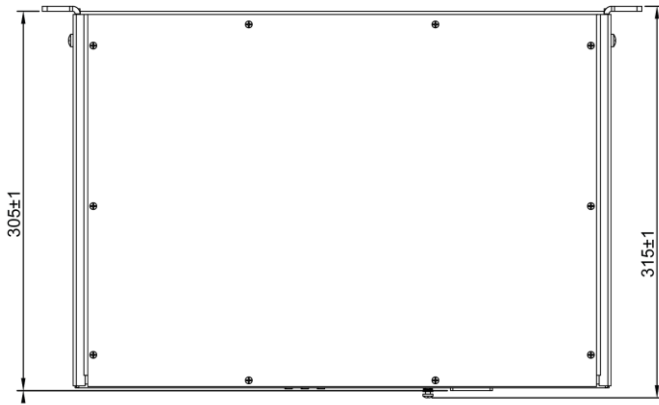

SIDE VIEW

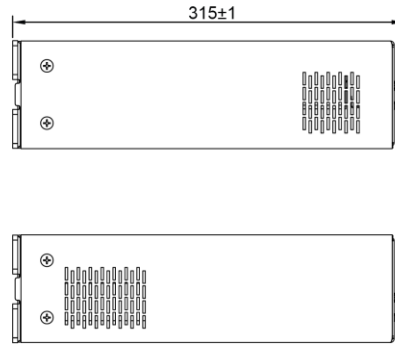

REAR VIEW

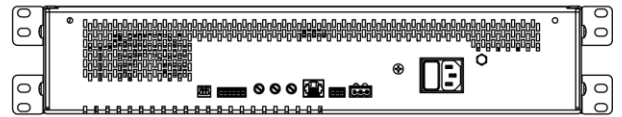

All dimensions in mm





**The WEEE Directive does not legislate that Zenitel, as a 'producer', shall collect 'end of life' WEEE.**

**This 'end of life' WEEE should be recycled appropriately by the owner who should use proper treatment and recycling measures. It should not be disposed to landfill.**

Many electrical items that we throw away can be repaired or recycled. Recycling items helps to save our natural finite resources and also reduces the environmental and health risks associated with sending electrical goods to landfill.



Under the WEEE Regulations, all new electrical goods should now be marked with the crossed-out wheeled bin symbol shown.

Goods are marked with this symbol to show that they were produced after August 13, 2005, and should be disposed of separately from normal household waste so that they can be recycled.