

3006200030

VSP-22M

Main Station- Watertight 20-Way



- ✓ 20 extension system
- ✓ 2 position group selector
- ✓ 10 position line selector
- ✓ Wall mount
- ✓ Waterproof housing for use at bridge wings and open deck areas

 IP66

Description

VSP-22M Watertight Main Station: Outdoor Batteryless Telephone Unit

The VSP-22M Watertight Main Station enhances outdoor communication on vessels with its sturdy construction and reliable performance. As part of our 20-Way Batteryless Telephone System, it's designed to withstand the elements while providing clear communication links, crucial in emergency situations. It features:

- ✓ **Watertight Housing:** Built to perform in outdoor settings, including bridge wings and open deck areas.
- ✓ **Selective Calling:** Enhanced with a 10-position selector switch and a 2-position group selector for efficient communication between stations
- ✓ **Strategic Installation:** Optimizes communication in critical outdoor locations, ensuring reliability during power outages.

The VSP-22M is specifically engineered for outdoor use on vessels, offering a weather-resistant solution that supports SOLAS-compliant safety communication protocols.

Technical Dimensions

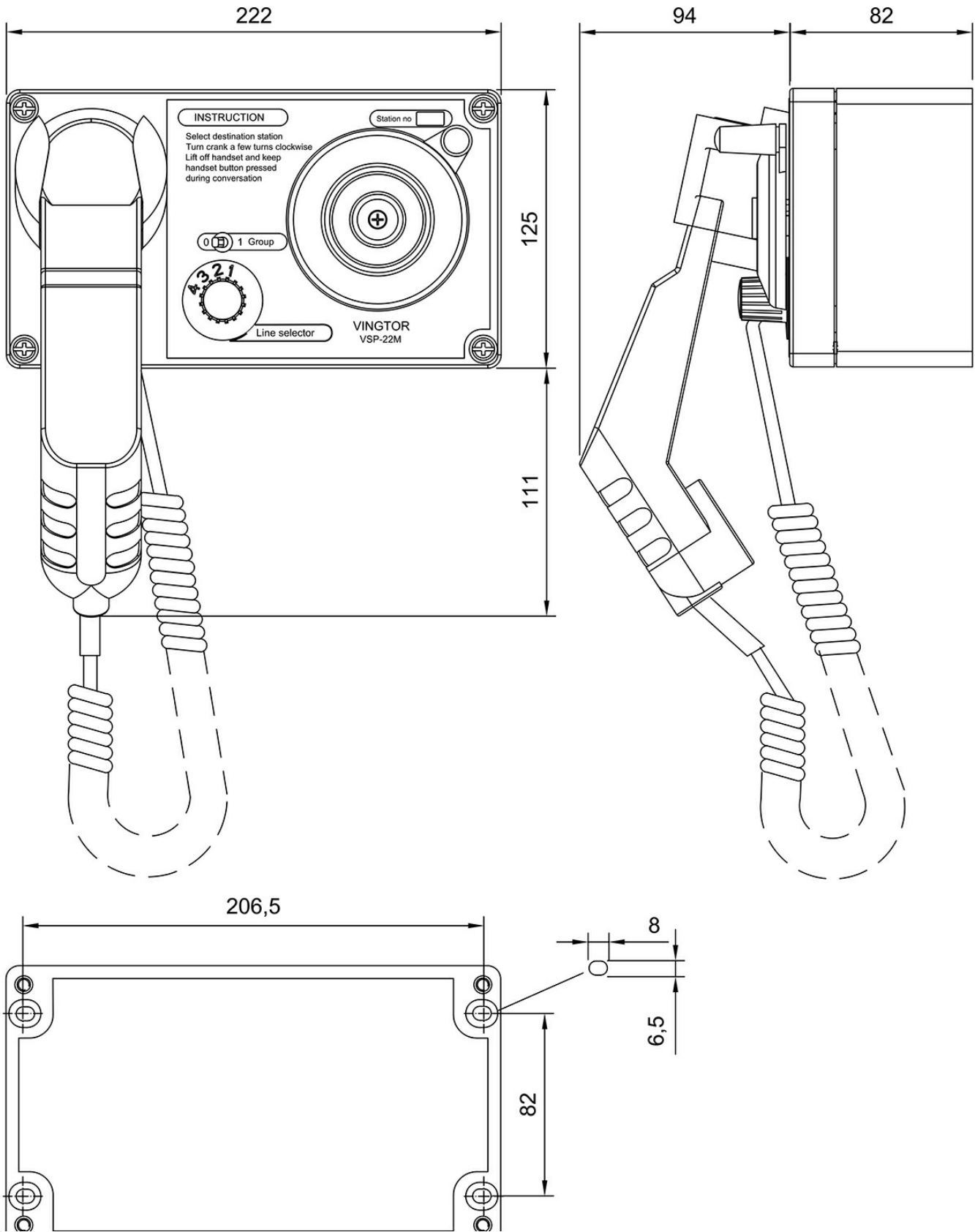

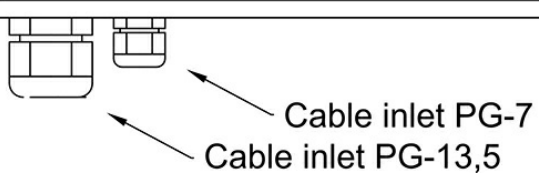

Specifications

GENERAL

Connections	Screw terminals
Housing	ROSE Box (AlSi12)
Handset	RA-250 w/holder
Color	Grey RAL7001 / Handset black
IP rating	IP-66
Operating temperature range	-25°C to 55°C
Weight	2.4 kg
Dimensions (WxHxD)	220 x 120 x 185 mm (with handset)
Compass Safe Distance	> 155cm

Accessories



CD-16

Plug Box

Item Number: 1020600982



VSP-36-PEL-A

Headset with boom mic, headband, and 10m cable

Item Number: 1020600771



VSP-36-PEL-A/20

Headset with boom mic, headband, and 20m cable

Item Number: 1020600772



IRR-VSPM-24

Relay box 24V DC for VSP M

Item Number: 3006200005



IRR-VSPM-220

Relay Box 220V AC for 20 Way system

Item Number: 3006200004



CD-4

Plugbox Waterproof

Item Number: 1020159000



VSP-36-PELP-A

Headset with boom mic, headband, and 10m cable

Item Number: 1020600773



VSP-36-PELP-A/20

Headset with boom mic, headband, and 20m cable

Item Number: 1020600774