

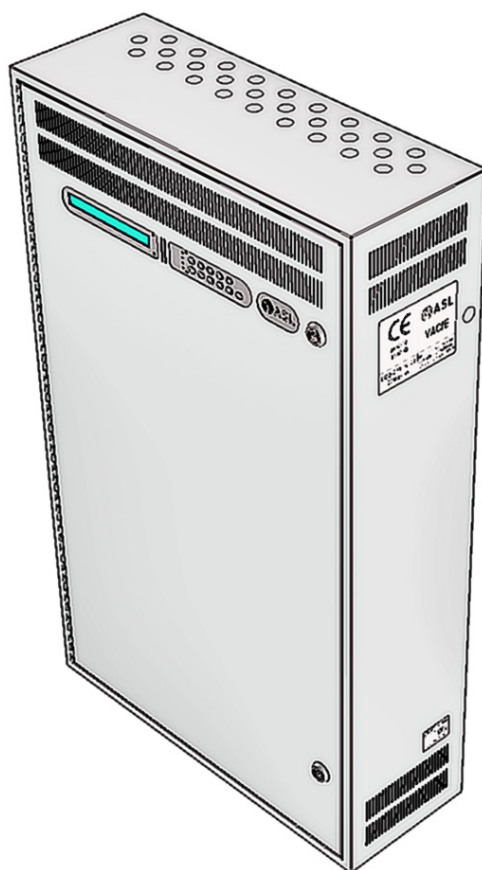

INTEGRA Products

Wall-Mount Voice Alarm Systems



Installation Guide

ASL Document Ref.: U-0732-0025.docx
Issue: 9 complete, approved - Date: 12/01/21
Part Number: M0732_21





This product is designed and manufactured to comply with the following EC Directives for electrical and electronic equipment:

- 1) Restriction of Hazardous Substances (RoHS) Directive: 2011/65/EU & 2015/863/EU
- 2) Electromagnetic Compatibility (EMC) Directive: 2014/30/EU
- 3) Low Voltage (LVD) Directive: 2014/35/EU

A Declaration of Conformity statement to the above Directives, listing the applicable harmonised standards to which the equipment conforms, is available on request.

The INTEGRA is assessed for safety as suitable for pollution degree 2 environments.

The INTEGRA is assessed for EMC as professional equipment (not intended for sale to the public) with rated power greater than 1 kW.

Failure to use the equipment in the manner described in the product literature will invalidate the warranty.



This product must be disposed of in accordance with the WEEE directive and local legislation.

Please refer to ASL downloads page for latest revisions of all user documentation.



www.asl-control.co.uk/downloads

Note:

Audinate® is a registered trademark of Audinate Pty Ltd.
Dante™ is a trademark of Audinate Pty Ltd.

Copyright © 2021 Application Solutions (Safety and Security) Limited

Application Solutions (Safety and Security) Limited
Unit 17 Cliffe Industrial Estate
Lewes - East Sussex
BN8 6JL - UK

Tel: +44(0)1273 405411 Fax: +44(0)1273 405415

www.asl-control.co.uk

All rights reserved.

Information contained in this document is believed to be accurate, however no representation or warranty is given and Application Solutions (Safety and Security) Limited assumes no liability with respect to the accuracy of such information.

Document Change History

Issue	Amendment Summary	Date
1	Draft release for internal use	11/05/16
2	Draft release for internal use	19/09/16
3	First release	23/03/17
4	<p>1) Updates to the Technical Specification:</p> <ul style="list-style-type: none"> a) INTEGRA part codes added b) SFP module power consumption added c) ANS Minimum Threshold / ANS Maximum Threshold updated from 50 dBA / 90 dBA to 55dBA / 95 dBA d) DANS limitation to local outputs 1 to 4 (not across DBB) added e) DANS limitation to inputs 1 to 4 removed f) Network Card USB port added g) Battery types added to the Charging Time <p>2) Lithium battery added to the Safety and Precaution</p> <p>3) Powering on sequence changed to ensure unit is powered from mains only for commissioning.</p>	16/06/17
5	<p>1) Network Switch wiring changed to prevent loss of power during firmware update (in Installation Procedure and in the Connections description).</p> <p><u>From:</u> Two power supply inputs of the Network Switch wired to the SWITCH/+SUPPLY terminal.</p> <p><u>To:</u> One power supply input of the Network Switch wired to the SWITCH/+SUPPLY terminal and the second input wired to the CONTACTS OUTPUTS/+SUPPLY terminal (see diagram in Installation Procedure and Connections).</p> <p>2) Network Switch patch cable moved from Network Card ETH4 to Router ETH2 port in the Installation Procedure. The change may facilitate recovery procedures. Diagram in Connections already showed connection to ETH2.</p>	05/09/17
6	<p>1) Safety and Precautions updated mostly for CB compliance, for example (see document for full details):</p> <ul style="list-style-type: none"> a) Isolation of multiple power supplies. b) Disconnect all power supplies/Electrical shock hazard. c) Installation not allowed at altitudes exceeding 2000 m. d) Use not allowed in tropical environments. e) Power supply isolation before installation, servicing or maintenance. f) No copper connections between peripherals and the INTEGRA between buildings. Fibre interconnection is acceptable. g) Lithium battery temperature rating to be greater than 75 °C. h) Battery replacement/disposal warnings. i) Battery storage and maintenance. j) Mains supply breaker (not be higher than 20 A, and Type C breaker). <p>Updates to warnings propagated to the Installation Procedure where applicable. Warnings regrouped for readability.</p> <p>2) Installation Procedure now includes step to label the external mains isolator (MAINS DISCONNECT DEVICES) for CB compliance.</p> <p>3) Correction to ETH3/4 pin description (from 1000Base-T to 100Base-T).</p> <p>4) Mains fuse changed (from T12AH 250 to T10A H 250) in rear panel images and descriptions.</p> <p>5) Mains range updated from 230 V AC +10% / -15% to 230 V AC +25% / -16%.</p> <p>6) Details added:</p> <ul style="list-style-type: none"> a) Fixing hole size b) DIP switch description c) CONTACT OUTPUT voltage and current d) How to remove/insert the SD card e) Frame PROCESSOR and COMMS LEDs fast flash to indicate overload condition. <p>7) Connection diagrams added for EMS/MPS/EAP01 microphones.</p>	13/03/19

	<p>8) Info added to Technical Specification:</p> <ol style="list-style-type: none"> Installation not allowed at altitudes exceeding 2000 m. Should not be used in tropical environments. INTEGRA-00 part code. 	
7	<p>Mains circuit breaker wording updated in Safety and Precautions.</p> <p><u>From:</u> The rating should not be higher than 20 A, and a Type C breaker should be used.</p> <p><u>To:</u> The rating should not be higher than 20 A. A Type C circuit breaker is recommended. The electrical supply must be designed and installed in accordance with local regulations.</p>	27/03/20
8	<ol style="list-style-type: none"> Document Change History added. QR code to ASL downloads page on back of the front cover. MAINS DISCONNECT DEVICES label PN corrected: <u>From:</u> ASL PN LA0732_13 <u>To:</u> ASL PN LA0732_06 EIA 568-B updated to T568B per Telecommunications Industry Association (TIA). On-board contact input description updated to warn that earth leakage faults may be reported by the Fire Panel using voltage-reversal method due to 100 kohms resistance to ground. If voltage-reversal method is required, use BMB01 to avoid possible earth leakage fault reports by the Fire Panel. RTC Lithium battery codes corrected: <u>From:</u> Panasonic CR2032/BS <u>To:</u> Panasonic BR2032 or Murata CR2032X Technical Specification updated: <ol style="list-style-type: none"> Residual Noise corrected from <90 dBu (A) to <-90 dBu (A). DANS limitation updated from outputs 1 to 4 to 1 to 12 (not across DBB). Mains supply at 110 V AC +15% / -10% added (note on software version requirements). Maximum AC VA rating and maximum AC Power consumption for 110 V AC added. Maximum number of EOL10K resistors (10x) for DC line monitoring added. Note on on-board contacts for Fire Panel using voltage-reversal method added (see 5) above). Note on Listen-in wiring changed: <u>From:</u> wiring via optional BOA01/BOA02 Break Out Adaptor <u>To:</u> non-standard wiring required. Refer to ASL for details. (same info added to the MPS connection diagram) Input/Output EQ Band Reset removed as now disabled on the RDT. Input EQ frequency range updated to V4.2.0.0: <u>From:</u> Low: 50 to 200 Hz / Low-Mid: 200 Hz to 20 kHz / High-Mid: 200 Hz to 20 kHz / High: 2 Hz to 20 kHz <u>To:</u> Low: 10 to 1 kHz / Low-Mid: 20 Hz to 20 kHz / High-Mid: 20 Hz to 20 kHz / High: 1 kHz to 20 kHz Output EQ frequency range updated to V4.2.0.0: <u>From:</u> Low (Band-1): 50 to 500 Hz / Band (2-9): 20 Hz to 20 kHz / High (Band-10): 2 to 12 kHz <u>To:</u> Low (Band-1): 20 to 1 kHz / Band (2-9): 20 Hz to 20 kHz / High (Band-10): 1 to 12 kHz Input/Output Peak Limiter now show range for Attack, Hold and Make Up Gain. Control relay removed from Note on Relays (as only supported on AS redundant systems). Mixing data updated to V4.2.0.0: <ul style="list-style-type: none"> “optional MIX-DSP Module” removed Footnote added: “Mixer used for listen-in only at the time of publication of this document.” INTEGRA-PRO parts added. Cables: Pirelli replaced by Prysmian. 	18/11/20

	<p>9) Updates due to support of 110 V AC +15% / -10%:</p> <ul style="list-style-type: none"> a) Rear panel images b) Mains description as applicable <p>10) Battery types updated:</p> <ul style="list-style-type: none"> a) Existing Power Sonic batteries codes updated to UL 94-V0 flammability rating for IEC / EN 62368-1 compliance: <u>From:</u> PS-12750, PG-12V65 and PG-12V80 <u>To:</u> PS-12750 FR, PG-12V65 FR and PG-12V80 FR b) New approved battery PG-12V75T FR added to warnings and Technical Specification. c) Info on UL 94-V0 flammability and Power Sonic codes added to warnings and Technical Specification. Also, warning to not use batteries with different Ah ratings. d) Battery max weight updated from 23 kg to 25 kg. e) INTEGRA max. weight updated from “max. 93.5 kg” to “max. > 95 kg”. <p>11) CE declaration - RoHS Directives updated to include 2015/863/EU.</p> <p>12) 1 GigE added to EHT5/6 ports description.</p> <p>13) Changes to make the document applicable to INTEGRA-PRO units:</p> <ul style="list-style-type: none"> a) “INTEGRA Products” on front cover and header. b) Re-wording and notes added as INTEGRA-PRO units may be supplied with a Hirschmann Network Switch and required cabling. c) Hirschmann added to titles as installation procedure and wiring are specific to Hirschmann switches. d) INTEGRA-PRO parts added to the Technical Specification. <p>14) Warning on battery types, storage and maintenance added at the beginning of the battery installation procedure.</p>	
<p>9</p>	<p>1) Typos corrected.</p> <p>2) Technical Specification updated:</p> <ul style="list-style-type: none"> a) Dante Brooklyn II module current consumption added. b) IP Audio capability added as footnote: Number of streams/channels in the footnote: depending on configuration 12 x PMC streams (6 x in + 6 x out) / 32 x Dante Rx channels. <p>3) LAMP TEST description updated: fault sounder only tested on Fault Master units.</p> <p>4) References to rear panel connectors corrected for BOA01 and BOA02.</p>	<p>12/01/21</p>

This page intentionally left blank.

Contents

1	Introduction.....	9
2	Safety and Precautions.....	11
3	Preparation.....	16
4	Unpacking and Handling.....	18
5	Main Components.....	19
5.1	Electronics Module.....	20
5.2	Optional Peripherals and Accessories.....	22
5.3	Router Output to Amplifier Hardwired Connection.....	24
6	Controls and Indicators.....	25
6.1	Power Supply Switches and Internal Indicators.....	25
6.2	Front Panel Indicators and Controls.....	27
7	INTEGRA Installation Procedure.....	28
7.1	Removing the Electronics Module (if required).....	28
7.2	Configuring the Electronics Module.....	31
7.2.1	Fitting Memory Card(s).....	31
7.2.2	Fitting Small Form-Factor Pluggable (SFP) Transceiver Module(s) to the Network Card (if used).....	32
7.2.3	Setting the Earth Lift Switch.....	32
7.2.4	Setting the DIP Switches on the Frame Controller.....	33
7.2.5	Fitting an Interface Card/Amplifier Module and Setting the Standby Links.....	34
7.2.5.1	Removing the Top and Bottom Covers.....	34
7.2.5.2	Removing the Surveillance Blanking Plates.....	35
7.2.5.3	Fitting a V2000-STBY Interface Card.....	35
7.2.5.4	Setting the Standby Amplifier Links.....	37
7.2.5.5	Fitting Blanking Plates.....	39
7.2.5.6	Fitting a LSZDC Interface Card.....	40
7.2.5.7	Installing an Amplifier Module.....	42
7.2.5.8	Fitting the Top Cover to the Electronics Module.....	43
7.2.5.9	Fitting the Bottom Cover to the Electronics Module.....	45
7.2.6	Setting the Internal Standby DIP Switches.....	46
7.3	Fitting Expansion DIN Rail Support Brackets (optional).....	47
7.4	Fitting a Hirschmann Network Switch (if required).....	49
7.5	Removing the Wall-Mount Frame.....	54
7.6	Installing the Wall-Mount Frame.....	55
7.7	Installing the Back Box.....	56
7.7.1	Installing the Back Box with Electronics Module Removed.....	56
7.7.2	Installing the Back Box with Electronics Module Fitted.....	58
7.8	Fitting a BMB01 Remote I/O to the Pre-Fitted DIN Rail (optional).....	60
7.9	Re-fitting the Electronics Module (if removed).....	62
7.10	Connecting the RJ45 Patch Leads to the Electronics Module (if removed).....	66
7.11	Connecting the Hirschmann Network Switch to the Electronics Module (if fitted).....	69
7.12	Fitting a BOA01/BOA02 Break Out Adaptor to the Pre-Fitted DIN Rail (optional).....	70
7.13	Connecting the External Mains Power Supply.....	71
7.14	Connecting the Field Wiring/Cabling.....	73
7.15	Fitting an Expansion DIN Rail (optional).....	76
7.15.1	Fitting a BMB01 Remote I/O Unit to the Expansion DIN Rail (optional).....	77
7.15.2	Fitting a BOA01/BOA02 Break Out Adaptor to the Expansion DIN Rail (optional).....	79
7.15.3	Connecting the Field Wiring to the Optional Items Fitted to the Expansion DIN Rail.....	80
7.16	Installing and Connecting the Batteries.....	81
7.17	Powering On the INTEGRA.....	84
8	Connections.....	85
8.1	Field Termination Board.....	85
8.2	Router Connections.....	89
8.2.1	Router Connectors.....	89
8.2.2	Break-Out Adaptor (BOA) Connections.....	98
8.2.2.1	BOA01 Connections.....	98
8.2.2.2	BOA02 Connections.....	103
8.3	Amplifier Frame Connections.....	105
8.3.1	Frame Connectors.....	106
8.3.2	LSZDC Surveillance Interface Connectors.....	109
8.3.3	Audio Interface Card Connectors.....	110
8.3.4	V2000-STBY Standby Interface Card Connectors.....	113
8.4	Expansion Unit / DBB Group Connection.....	113

8.5	BMB01 Connection to INTEGRA	114
8.6	Hirschmann Network Switch Connection to INTEGRA	114
8.7	EMS Fire Microphone Connection to INTEGRA	115
8.8	MPS Fire and Paging Microphone Connection to INTEGRA	116
8.9	EAP01 Fire Microphone Connection to INTEGRA	117
9	Technical Specification	118
9.1	General	118
9.2	Router	119
9.3	D150 Amplifier Module.....	122
9.4	D500 Amplifier Module.....	123
9.5	LSZDC Surveillance Interface Card	123
9.6	V2000-STBY Standby Interface Card	123
9.7	Batteries.....	124
9.8	Part Codes.....	124
10	Mechanical Dimensions	126
11	Storage and Preservation	127
12	Packing for Return	128
	Service and Warranty.....	131

1 Introduction

This document describes how to install an INTEGRA and its optional items. It also provides an overview of the main components, controls and indicators.

The diagram below provides an overview of the installation sequence.

The installation is divided into different procedures which should be carried out in the order listed below.

	Summary of Task	Section	Page
Safety and Precautions	Read the safety and precautions instructions and guidelines.	2	11
Preparation	Gather documentation, tools, equipment and rack.	3	16
Unpacking and Handling	Unpack equipment.	4	18
Installation	<ol style="list-style-type: none"> 1. Unlock and open the unit's door. 2. Remove the Electronics Module (if required). 3. Configure the Electronics Module (as required). <ol style="list-style-type: none"> 3.1. Fit memory card(s). 3.2. Fit Small Form-Factor Pluggable (SFP) Transceiver Module(s) to the Network Card (if used). 3.3. Set the Earth Lift switch. 3.4. Set the DIP switches on the Frame Controller. 3.5. Fit interface cards/amplifier Modules and set the standby internal links (as required). <ol style="list-style-type: none"> 3.5.1. Remove the top and/or bottom covers. 3.5.2. Remove surveillance blanking plates. 3.5.3. Fit a V2000-STBY Interface Card. 3.5.4. Set the standby amplifier links. 3.5.5. Fit blanking plates. 3.5.6. Fit LSZDC Interface Cards. 3.5.7. Install amplifier modules. 3.5.8. Re-fit the top cover. 3.5.9. Re-fit the bottom cover. 3.6. Set the internal standby DIP Switches. 4. Fit Expansion DIN Rail support brackets (if used). 5. Fit the Network Switch (if required). 6. Remove the wall-mount frame. 7. Install the wall-mount frame. 8. Install the back box as suitable. <ol style="list-style-type: none"> 8.1. Install the back box with Electronics Module Removed. 8.2. Install the back box with Electronics Module Fitted. 9. Fit a BMB01 Remote I/O Unit to the supplied DIN rail (if used). 10. Re-fit the Electronics Module (if removed). 11. Connect the RJ45 patch leads to the Electronics Module (if removed). 12. Connect the Network Switch to the Electronics Module (if fitted). 13. Fit a BOA01/BOA02 Break Out Adaptor to the supplied DIN Rail (if used). 14. Isolate power supplies. 15. Connect the external mains power supply. 		

Continued on next page

16.	Connect the field wiring/cabling.	7.14	73
17.	Fit an Expansion DIN Rail (if used).	7.15	76
17.1.	Fit a BMB01Remote I/O Unit to the Expansion DIN Rail (if used).	7.15.1	77
17.2.	Fit a BOA01/BOA02 Break Out Adaptor to the Expansion DIN Rail (if used)	7.15.2	79
17.3.	Connect the field wiring to the optional items fitted to the Expansion DIN Rail.	7.15.3	80
18.	Install and connect the batteries.	7.16	81
19.	Power on the INTEGRA if mains power supply is connected.	7.17	84
20.	Commission the INTEGRA.  No commissioning instructions are provided in this document. Refer to INTEGRA User's Manual appropriate for the software version of your INTEGRA unit. The INTEGRA software version is available in the front panel menu option Configuration→Router→Identity→S/Ware→Host CP .	-	-
21.	Close and lock the door.	-	-

2 Safety and Precautions

Observe all safety information both on the equipment and in this section.

Weight



The INTEGRA is heavy (max. > 95 kg).

Do not try to move an assembled unit. Move and handle with care the sub-assemblies and batteries to avoid strain or impact injuries.



It is VITAL that it is mounted to suitably robust walls or structures using appropriate fixing for the specific wall type.

Local regulations, wall type and wall condition will all need to be considered, and therefore, the exact fixing method must be determined by suitably qualified engineers or installers.

Equipment Handling



Take care when handling the INTEGRA and its sub-assemblies. Metal parts may have sharp edges.

Installation



The INTEGRA is designed for professional use only and must be installed such that there is no operator access to the internals of the INTEGRA or its wiring.



The INTEGRA must be correctly secured to the building structure according to the instructions in this manual before operating.



Knockouts are provided in the top and back of the INTEGRA for entry/exit of external wiring. These must be fitted with cable glands or similar providing at least IP3X ingress protection to guard against metal or burning objects entering the enclosure and causing a hazard and to permit compliance to EN 54-16.



Copper connections between peripherals and the INTEGRA should not be run between buildings as the equipment may be subjected to transient voltages due to atmospheric discharges and faults within power distribution systems. Fibre interconnection is acceptable.

Environmental



Always ensure that adequate ventilation is provided for the INTEGRA.

Do not block side or front vents and do not obstruct air flow behind enclosure.



The temperature and humidity ranges shown in the specifications for the INTEGRA must not be exceeded.



The INTEGRA should not be installed at altitudes exceeding 2000 m.



The INTEGRA should not be used in tropical environments.



The INTEGRA must not be installed in an area that is subject to a corrosive atmosphere, excessive moisture or may allow water or other liquids to come into contact with the unit or its external connections.



Objects containing liquids should not be placed upon the INTEGRA.

Power Connections



Ensure that the mains supply cabling is adequately rated for the unit's operating current and temperature¹, and is protected against short-circuit by a correctly rated fuse or circuit breaker.

The rating should not be higher than 20 A. A Type C circuit breaker is recommended.

The electrical supply must be designed and installed in accordance with local regulations.

The INTEGRA power rating is provided in the equipment on the top of the Electronics Module and in Section "9 Technical Specification" (page 118).



Always ensure that the INTEGRA is correctly earthed by connection to an AC mains supply with a suitably rated protective earth connection.



The INTEGRA is designed for permanent connection to a mains supply. A readily accessible all-pole mains isolator with a separation of 3 mm in each pole shall be incorporated in the electrical installation.



The INTEGRA is protected from overload by single pole phase fusing. If connected to an unpolarised mains supply, the building installation must provide double pole phase/neutral fusing of appropriate rating.

Isolation of Multiple Power Sources



The INTEGRA has more than one connection supplying hazardous voltages or hazardous energy levels. Prominent markings located close to the entry point provided for a service person to gain access to the hazardous points shall be provided to indicate which disconnection device or devices isolate the equipment completely and which disconnect devices can be used to isolate each section of the equipment.

Disconnect devices should remain accessible at all times.

EMC

In the close proximity of some radio frequency transmitters, the signal to noise ratio of the INTEGRA may be reduced. If this occurs, re-location of the INTEGRA or the signal cables is recommended.

Ground Loops

It is possible to form a ground loop (earth loop or hum loop) when connecting pieces of audio equipment using unbalanced connections that provide alternative earth connections via their cable screens. Such ground loops result in audible "hum" from the system.



Never disconnect the mains earth from the plug to attempt to cure a ground loop. In the event of a fault, the equipment casing could become live.

¹ In normal operation the internal temperature rise above external ambient is 15 °C.

LED and Laser Components

The INTEGRA is a Class 1 LED product.

The INTEGRA with fibre optic modules is a Class 1 Laser product.

ESD Precautions



The INTEGRA sub-assemblies contain static-sensitive devices.

Observe ESD precautions when handling the interface cards, the amplifier modules or electronics module with covers removed or when making connections.

Servicing and Installation



Servicing and installation work should be carried out by qualified personnel only.



Service Access is permitted only to those with the necessary training and expertise and can take responsibility for their own safety when working on the INTEGRA.

The front door must be kept locked, the key removed and provided only to authorised personnel.



The INTEGRA contains wiring that is energised to 230 V AC mains and 100 V RMS audio signals at up to 20 kHz.

Terminals marked with the ⚡ symbol are hazardous, and the external wiring connected to these terminals requires installation by instructed personnel.



The INTEGRA may be energised after operation of a fuse or power off by the MAINS and BATTERY switches on the Electronics Module.



Caution! Electrical shock hazard. Disconnect all power supplies.



Always isolate the mains and battery supplies by switching off the INTEGRA mains supply at the external isolator and at the internal battery supply circuit breaker before installation, servicing or maintenance. In installations where the external mains supply isolation switch is not accessible, unplug the mains power supply cable from the Electronics Module.



The INTEGRA may still be energised after isolating the mains and battery supplies.

After the mainframe “processor” LED has stopped flashing, leave the INTEGRA for another 5 minutes before attempting internal servicing.



Use caution when working with the INTEGRA. The Electronics Module case temperature can exceed 70°C.

Fuse Replacement



Always replace blown fuses with the correct type and rating.

Amplifier and Interface Card Replacement



Use caution when replacing amplifiers and/or interface cards. The Electronics Module case temperature and amplifier temperature can exceed 70°C.



Caution! Electrical shock hazard. Disconnect all power supplies.



Always isolate the mains and battery supplies by switching off the INTEGRA mains supply at the external isolator and at the internal battery supply circuit breaker before installation, servicing or maintenance. In installations where the external mains supply isolation switch is not accessible, unplug the mains power supply cable from the Electronics Module.



The INTEGRA may still be energised after isolating the mains and battery supplies.

After the mainframe 'processor' LED has stopped flashing, leave the INTEGRA for another 5 minutes before attempting internal servicing.

Battery Replacement, Handling and Storage



Caution! Risk of explosion if battery is replaced by an incorrect type.

The INTEGRA box contains two lead-acid batteries. Replace only with type Power Sonic PS-12750 FR, PG-12V75T FR, PG-12V65 FR or PG-12V80 FR.

- Do not mix battery types with different Ah ratings in an INTEGRA unit.
- To ensure IEC / EN 62368-1 compliance, INTEGRA batteries must be rated to UL 94-V0 flammability. Note that any Power Sonic batteries without FR (V0) product codes are only rated to UL 94-HB flammability.

The Electronics Module contains a lithium battery. The maximum temperature rating of the battery varies from manufacturer to manufacturer. The temperature rating of the chosen battery must be greater than 75°C (for example, Panasonic BR2032 or Murata CR2032X).



Batteries are heavy (max. 25 kg each). Please move and handle with care to avoid personal injuries and/or damage to the batteries.



External 24 V DC batteries connected to this unit can deliver very high currents that could cause fire or burns.

Take care to avoid short-circuits of the battery supply by tools or jewellery.

Insulated battery terminal covers must always be fitted.

Do not allow tools or unconnected cables to rest on top of batteries.

Always use insulated tools.



When reconnecting the battery always ensure that the BATTERY switch is OFF before the battery circuit breaker is turned on.



Batteries should not be exposed to excessive heat such as sunshine, fire, etc.

External batteries should not be exposed to temperatures exceeding 25°C or stored for periods of more than a few weeks without charging as this can significantly reduce their service life.



Dispose of all batteries responsibly by using authorised Waste Contractors and by ensuring all relevant local waste regulations are followed.



Dispose of used batteries according to the instructions.

Never bury in the ground or incinerate at end-of-life.

Optical Fibre Connector and Module Handling

Optical fibre connectors and modules are precision-made components and must be handled accordingly.

Do not expose optical fibre connectors and modules to impact as damage to the surface of optical connectors may cause higher attenuation impairing the transmission quality.

Always fit optical fibre connectors and modules with protective caps to guard them against mechanical damage and contamination. The protective caps should only be removed prior to installation.

Once the protective caps have been removed, check the surfaces of the optical fibre connectors to ensure that they are clean, and clean them if necessary. Clean the optical fibre connectors using a special optical fibre cleaning tool or a clean lint-free cellulose cloth. Isopropyl alcohol (99%) can be used for cleaning.

Blanking Plate Disposal



Any blanking plates and knockouts removed from the INTEGRA as part of the installation process ideally should be recycled as metal or otherwise responsibly disposed of by following WEEE protocols.

3 Preparation

1. Read and observe the safety instructions and guidelines in Section “2 Safety and Precautions” (page 11).



Failure to follow these instructions and guidelines may cause personal injury and/or damage to the equipment.

2. Gather the following documentation, tools and fixings:

- The system design documentation of the specific location
- A small flat-blade screwdriver
- A torque driver with extension and bits for M3, M4, M5, M6 and M8 nuts
- AF spanner with insulated handle for 6 mm nuts
- A pair of wire cutters/strippers
- Suitable ferrules and crimping tool
- Cable glands or conduits (Ø 20 mm)

The cable glands or conduits must provide at least IP3X ingress protection to guard against metal or burning objects entering the enclosure and causing a hazard and to permit compliance to EN 54-16.

- The appropriate wall-mount fixings and tools. Fixing holes are Ø 7.5 mm.
- A torch



The INTEGRA is heavy (max.> 95 kg) and it is VITAL that it is mounted to suitably robust walls or structures using appropriate fixing for the specific wall type.

Local regulations, wall type and wall condition will all need to be considered, and therefore, the exact fixing method must be determined by suitably qualified engineers or installers.

- ESD wrist strap or other grounding device
- Antistatic mat or antistatic foam

3. Gather the equipment (in their original packing):

- The INTEGRA:
 - Back box with Electronics Module and battery tray
 - 1 x battery link cable
 - 2 x door keys
 - P-clips, cable ties, and fixings for mains supply wiring
 - 3 x yellow patch leads (500 mm) (if not supplied fitted)
 - 2 x blue patch leads (300 mm) (if not supplied fitted)
 - 10 x grey patch lead (200 mm) (if not supplied fitted)
 - 1 x label (MAINS DISCONNECT DEVICES)

- Battery pack (2 x 12 V BATTERY): Power Sonic PS-12750 FR, PG-12V75T FR, PG-12V65 FR or PG-12V80 FR

Do not mix battery types with different Ah ratings in an INTEGRA unit.

- D500 and/or D150 amplifier module(s) as required by the system design (if not supplied fitted)
- Interface cards as required by the system design: LSZDC V2000 Line Surveillance Interface Card and V2000-STBY V2000 Standby Interface Card (if not supplied fitted)
- Surveillance blanking plates (ASL V2000-RBLANK) as required by the system design
- Optional items:
 - Small Form-Factor Pluggable¹ (SFP) Transceiver Module(s)
 - BMB01 Remote I/O Unit and the BMB01 Installation Guide (ASL U0450-1693)
 - NETWORK-SWITCH-MM4 (or NETWORK-SWITCH-SM4) and INTEGRA-SWITCH-MOUNT
 - INTEGRA-DIN-KIT: Expansion DIN rail and support brackets
 - BOA01/BOA02: Break-out adaptor

4. Gather the required cabling and wiring for installation of optional items:

- Network Switch: 1 x CAT5 patch lead (300 mm) and wiring as specified in Section “8.6 Hirschmann Network Switch Connection to INTEGRA” (page 114)
- BMB01 Remote I/O unit: wiring as described in Section “8.5 BMB01 Connection to INTEGRA” (page 114)
- BOA01/BOA02: CAT5 patch leads (300-500 mm) (as required)

¹ SFP modules: refer to ASL for availability and compatibility.

4 Unpacking and Handling

1. Observe any markings or warnings on the package prior to handling and opening.



The INTEGRA is heavy (max. 1 > 95 kg). Do not try to move an assembled unit. Move and handle with care sub-assemblies and batteries to avoid strain or impact injuries.

2. Check the equipment package for signs of damage during transport. Report problems to the carrier or supplier.

3. Unpack the equipment in a dry area, handling the equipment with care.



The Electronics Module, interface cards and amplifier modules contain static-sensitive devices. Observe ESD precautions when handling the interface cards, the amplifier modules or electronics module with the covers removed.

4. Check the equipment package contents for completeness. Report any missing items immediately.

5. It is advisable to retain the original equipment packing (containers and materials) in the event that the equipment ever needs returning for service.

6. If the packing is not to be retained, the packing materials should be either recycled or disposed of according to local regulations.

7. Ensure that the name and address of the Authorised Distributor from whom you purchased the product is recorded on the “Service and Warranty” page of this document for future reference.

8. Repacking instructions are provided in Section “10 Packing for Return” (page 128).

5 Main Components



The INTEGRA is heavy (max. > 95 kg) and it is VITAL that it is mounted to suitably robust walls or structures using appropriate fixing for the specific wall type.

Local regulations, wall type and wall condition will all need to be considered, and therefore, the exact fixing method must be determined by suitably qualified engineers or installers.

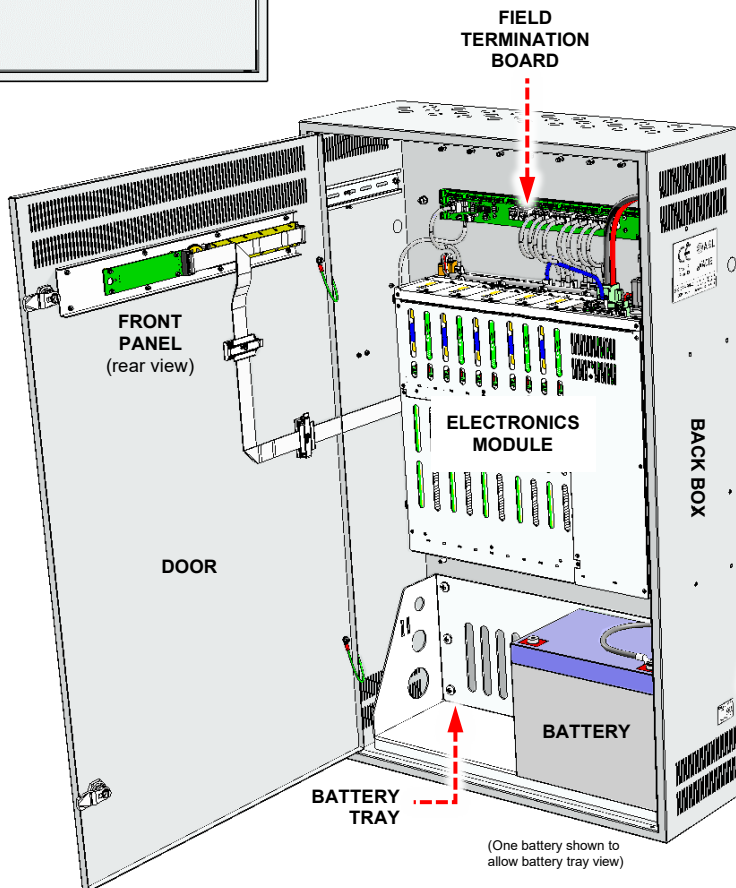
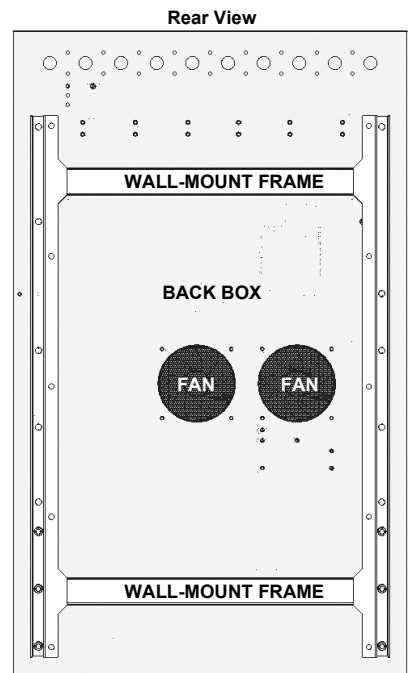
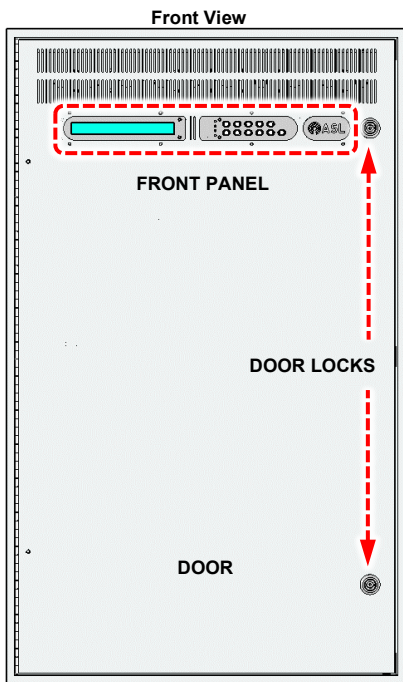

Serial Number Label / Build Standard (BS) Version



(Actual label may differ from image shown.)



The last part of the serial number indicates the unit's Build Standard (BS) version.
Example: 1635-000010-03 → BS Version = 03

5.1 Electronics Module

The Electronics Module has two distinct parts: the Router and the Amplifier Frame as shown in the diagram below. Both parts have user-installable components:

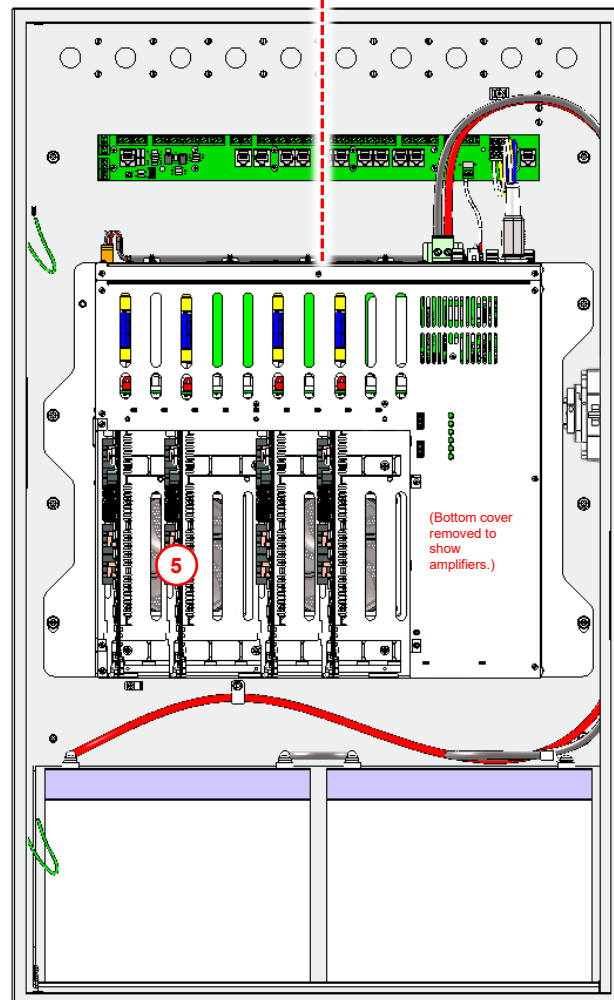
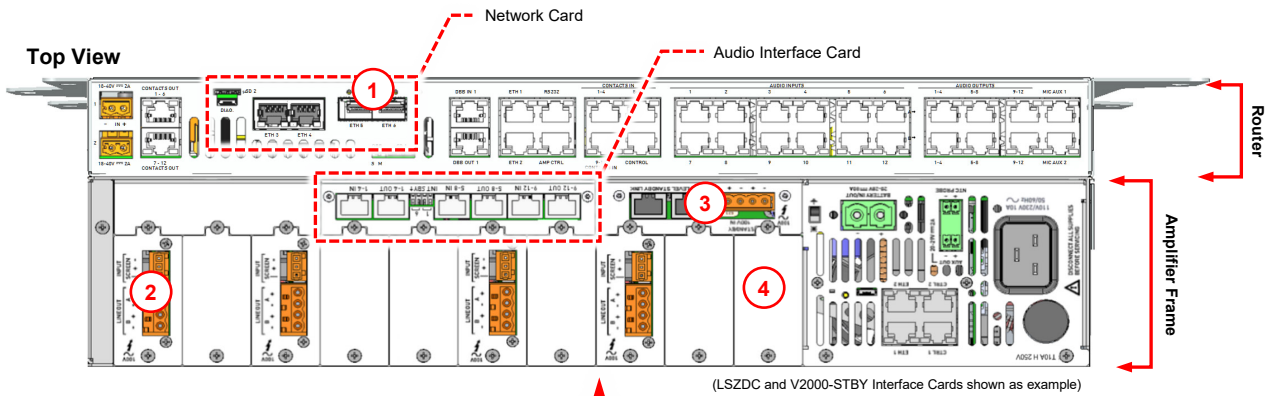
- Amplifier Frame: D150/D500 Amplifier Modules, LSZDC Line Surveillance Interface Cards, V2000-STBY Standby Interface Cards
- Router fitted with Network Card: Small Form-Factor Pluggable (SFP) Transceiver Modules (refer to ASL for availability and compatibility)

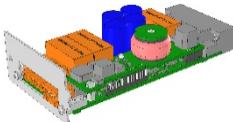
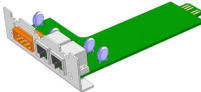

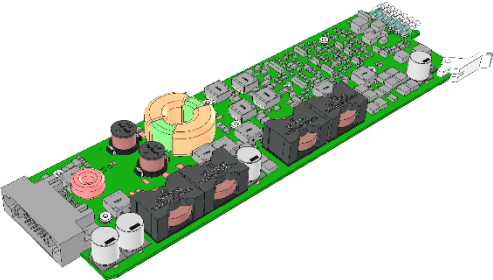
Electronics Module – User-Installable Items		
Item	ASL Order Code / Description	Image (not to scale)
①	<p>SFP Module(s) (optional):</p> <ul style="list-style-type: none"> • MM (multimode fibre) • SM (single mode fibre) module • RJ45 (copper) module 	 <p>(Example only. Refer to ASL for availability and compatibility)</p>
②	LSZDC Line Surveillance Interface Card	
③	V2000-STBY Standby Interface Card (optional)	
④	V2000-RBLANK Surveillance Blanking Plate (pack of 10)	
⑤	<p>D150 Amplifier Module</p> <p>D500 Amplifier Module</p>	

5.2 Optional Peripherals and Accessories

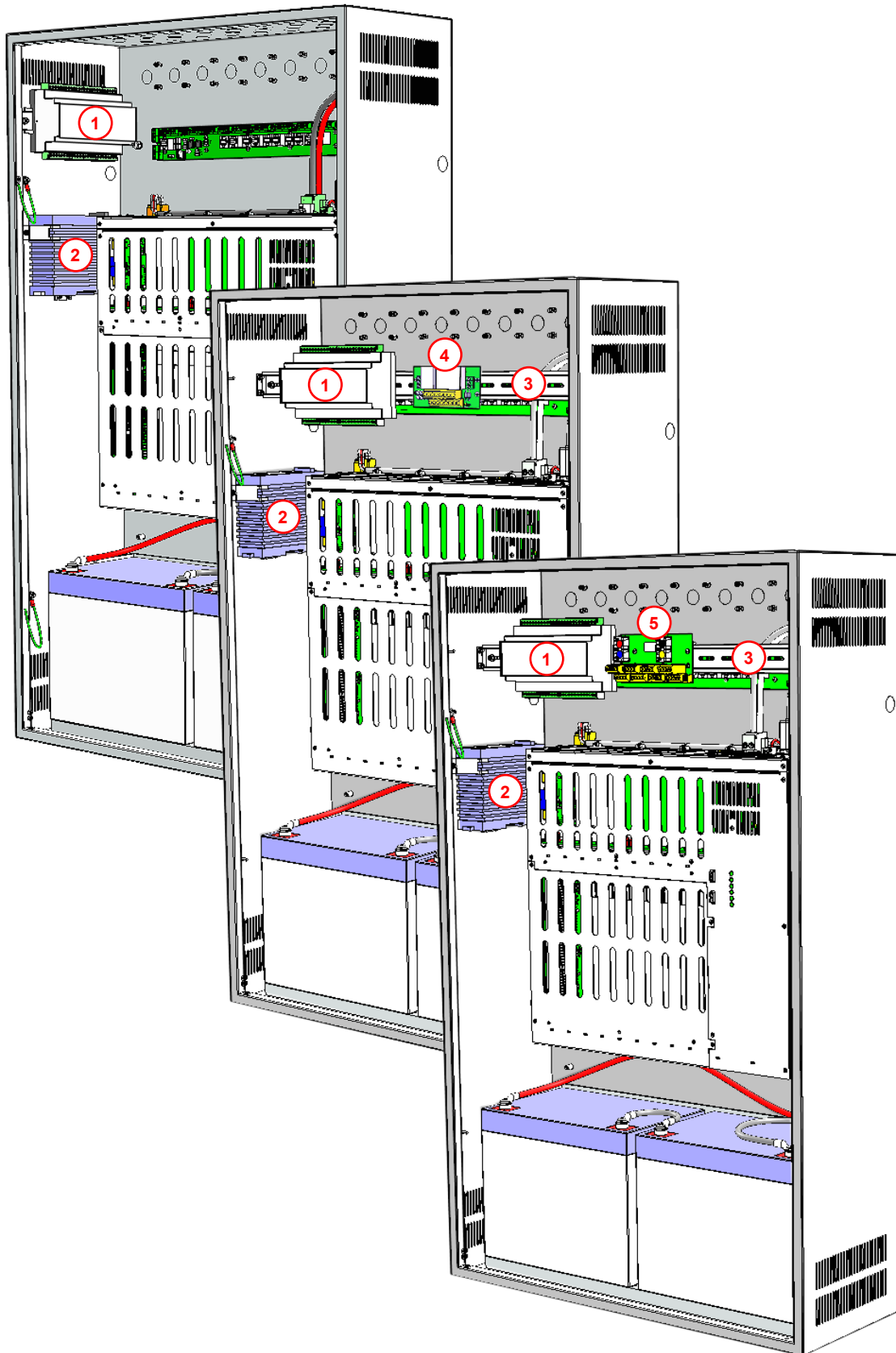

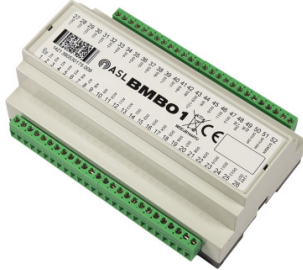
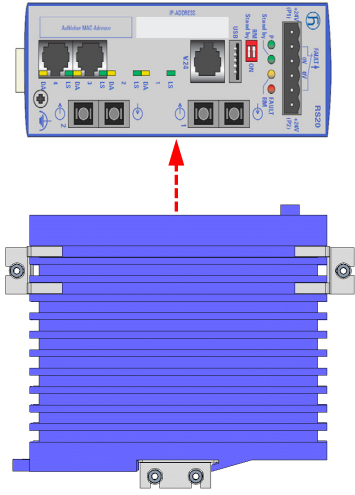
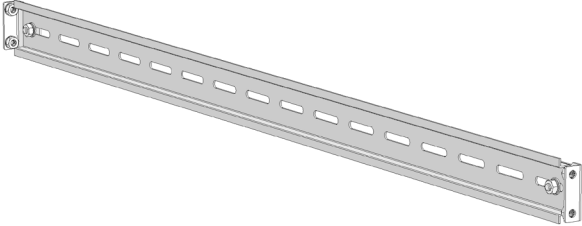
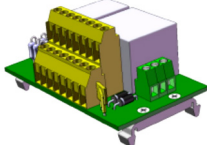
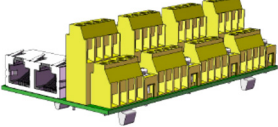
Optional Peripherals and Accessories		
Item	ASL Part Code ¹ / Description	Image (not to scale)
①	BMB01 Remote I/O Unit	
②	<ul style="list-style-type: none"> NETWORK-SWITCH-MM4: Dual multimode fibre + 2 x RJ45 or NETWORK-SWITCH-SM4: Dual single mode fibre + 2 x RJ45 INTEGRA-SWITCH-MOUNT: Network Switch mounting kit 	
③	INTEGRA-DIN-KIT: Expansion DIN Rail and mounting kit	
④	BOA01 Break-Out Adaptor	
⑤	BOA02 Break-Out Adaptor	

¹ Refer to ASL for latest product list and part codes.

5.3 Router Output to Amplifier Hardwired Connection

Figure 1 Standard Router output to amplifier connection

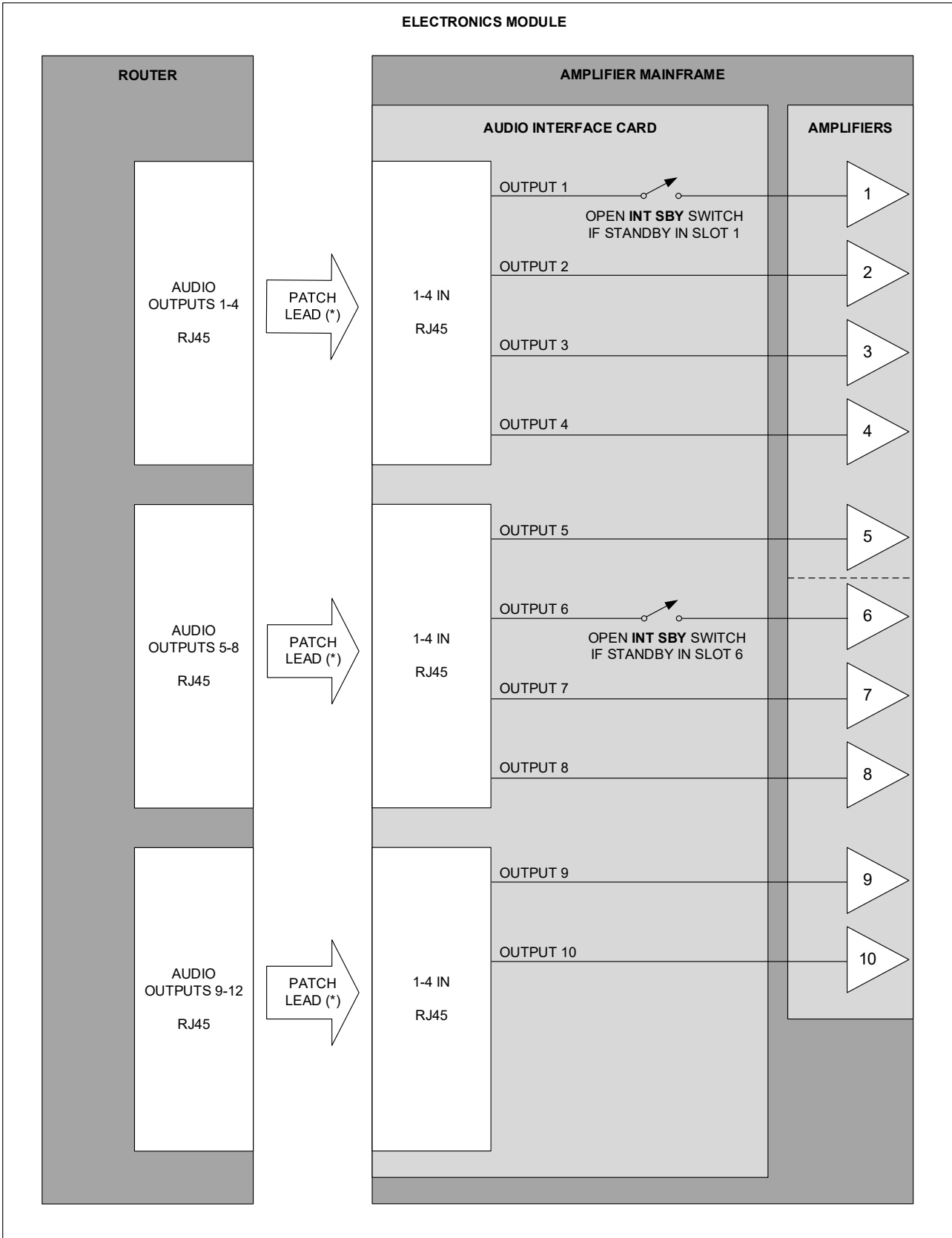

(*) RJ45 patch leads are factory fit or fitted as part of the INTEGRA installation.

6 Controls and Indicators

6.1 Power Supply Switches and Internal Indicators

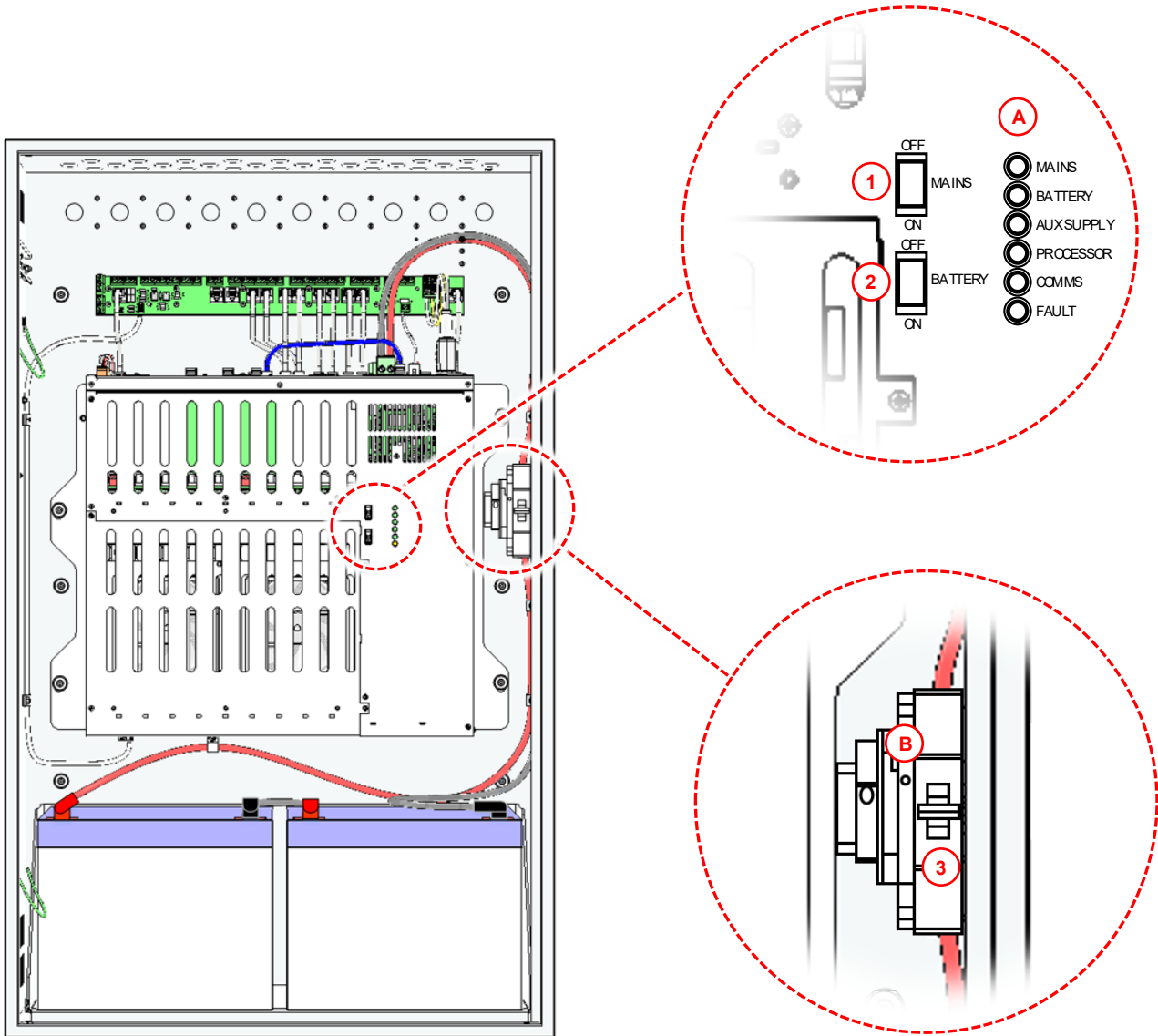

Item	Description		
Switches	①	MAINS: Enables or disables the mains power supply from the Power Supply Unit (PSU) to the INTEGRA.	
	②	BATTERY: Enables or disables the power supply from the batteries to the INTEGRA.	
	③	Battery Isolation Switch: Connects or disconnects the power supply from the batteries to the INTEGRA.	
		<p>The INTEGRA may be energised after operation of a fuse or power off by the MAINS and BATTERY switches (① and ②).</p> <p>Always isolate the mains and battery supplies by switching off the INTEGRA mains supply at the external isolator AND at the internal battery isolation switch ③ before installation, servicing or maintenance.</p> <p>Ensure that the battery isolation switch ③ is turned off whilst updating configurations (particularly when changing between battery and non-battery configurations).</p> <p>When reconnecting the battery always ensure that the BATTERY switch ② is off before the battery isolation switch ③ is turned on.</p>	
Indicators (LED)	Ⓐ	MAINS (green)	Lit when mains power present at rear and front MAINS switch on.
		BATTERY (green)	Lit when battery power present at rear and front BATTERY switch on.
		AUX SUPPLY (green)	Lit to indicate that auxiliary supply is available at the rear AUX OUT connector.
		PROCESSOR (green)	Indicates the processor health state: <ul style="list-style-type: none"> • flashing: healthy • off: internal processor fault
		COMMS (green)	Indicates the internal and Ethernet communication health state: <ul style="list-style-type: none"> • flashing: healthy • off: internal comms fault • steady on: Ethernet comms fault
		FAULT (amber)	Lit to indicate power supply or frame controller fault(s).
	Ⓑ	(green)	Lit when the battery power to the Router (PSU input 1) is enabled.
Notes: <ul style="list-style-type: none"> a) When powered down and with mains supply or battery connected, the FAULT LED will be lit and the PROCESSOR LED will be flashing. b) The PROCESSOR and COMMS LEDs fast flash when an overload condition is present. 			

6.2 Front Panel Indicators and Controls

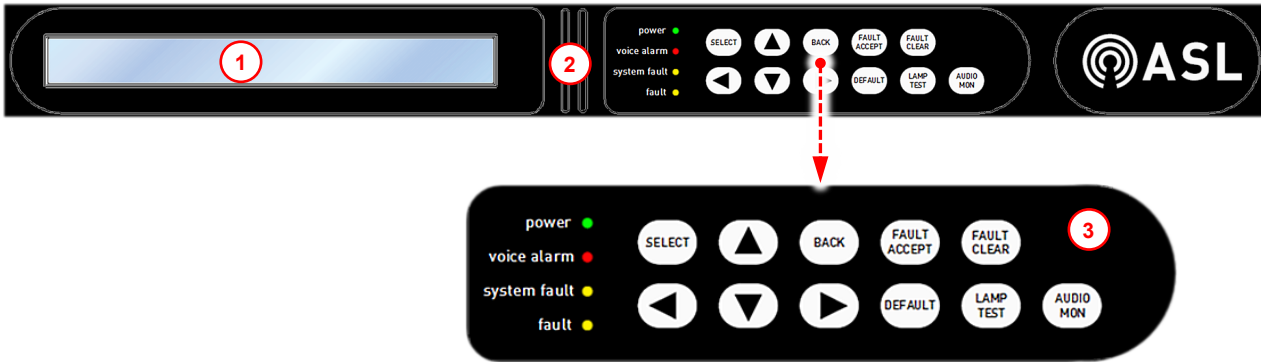

Item		Description	
①	LCD Display	2 x 40 backlit alphanumeric display Used to display control menu, faults, overall system status, and configuration data.	
②	Loudspeaker	Fault Sounder and Audio Monitor	
③	Indicators (LED)	power (green)	Lit if the unit is receiving DC power.
		voice alarm (red)	Lit to indicate that a voice alarm condition is present in the PA/VA system.
		system fault (yellow)	Lit to indicate that a system fault has been detected in the PA/VA system. This requires immediate action as part(s) of the system used for emergency functions may have been affected. A system fault will always cause the “fault” LED to be lit as well. A system fault is triggered by a failure of any processor or memory, critical to the Voice Alarm system, including those of the INTEGRA itself. A communication fault between the INTEGRA and any equipment or device that has been configured at the INTEGRA and that is critical to Voice Alarm functions will also trigger a system fault.
		fault (yellow)	Lit to indicate that the unit has detected a fault. Flashes if a fault has not yet been accepted.
	Keys	◀ ▶	The left and right arrow keys move the item selection in the direction selected, to the next item in the menu. The selected item is indicated by [brackets] around the selection.
		▲ ▼	The up and down arrow keys toggle a selection, or increment a number, or a letter of the alphabet when editing.
		SELECT	Press after selecting an item to confirm the selection.
		BACK	Press after selecting an item to cancel the selection. If pressed repeatedly, it returns the display to the top-level menu.
		FAULT ACCEPT	Accepts all current faults, steadies the flashing fault LED indication, and turns off the audible alarm until a new fault condition occurs.
		FAULT CLEAR	Clears all faults and sets all connected equipment to the “no faults” state, which also cancels any amplifier changeovers in effect. If there are any faults present in the system, then they are detected anew, and reported again.
		AUDIO MON	Selects Audio Monitor sub-menu on the LCD display.
		LAMP TEST	Tests all indicators on the front panel. The sounder, the LCD display, and the fans located at the rear of the back box are also tested. The display shows “LAMP + LCD + SOUNDER TEST + FAN TEST”, and then, solid black characters. The menu locks for the entire duration of the test. Notes: a) The fault sounder is only tested on Fault Master units. b) Note that the Amplifier Frame built-in fan is not tested using the LAMP TEST key. It can be tested by pressing the FAULT CLEAR key.
		DEFAULT	Press to clear previously configured text strings quickly during system configuration, or to return fields to their default values.

7 INTEGRA Installation Procedure



Please read and observe the instructions and guidelines in Section “2 Safety and Precautions” (page 11) prior to installation and all safety information on the equipment. Failure to follow these instructions and guidelines may cause personal injury and/or damage to the equipment.



For clarity, the installation is divided into different procedures which should be carried out in the order listed below.

7.1 Removing the Electronics Module (if required)



The Electronics Module is not required to be removed if the INTEGRA is pre-configured with all required modules (Interface Cards, amplifiers and optional items). However, notice that INTEGRA is heavy (max. 47.5 kg with Electronics Module fitted and no batteries), and it may take two or more people to install the Back Box with Electronics Module fitted.



The Electronics Module should be removed from the back box in order to install Interface Cards (LSZDC and/or V2000-STBY), set the standby amplifier links, or install a Network Switch.

1. Unlock and open the unit's door.
2. Disconnect the ribbon cables from the headers on the left-hand side of the Electronics Module (A).

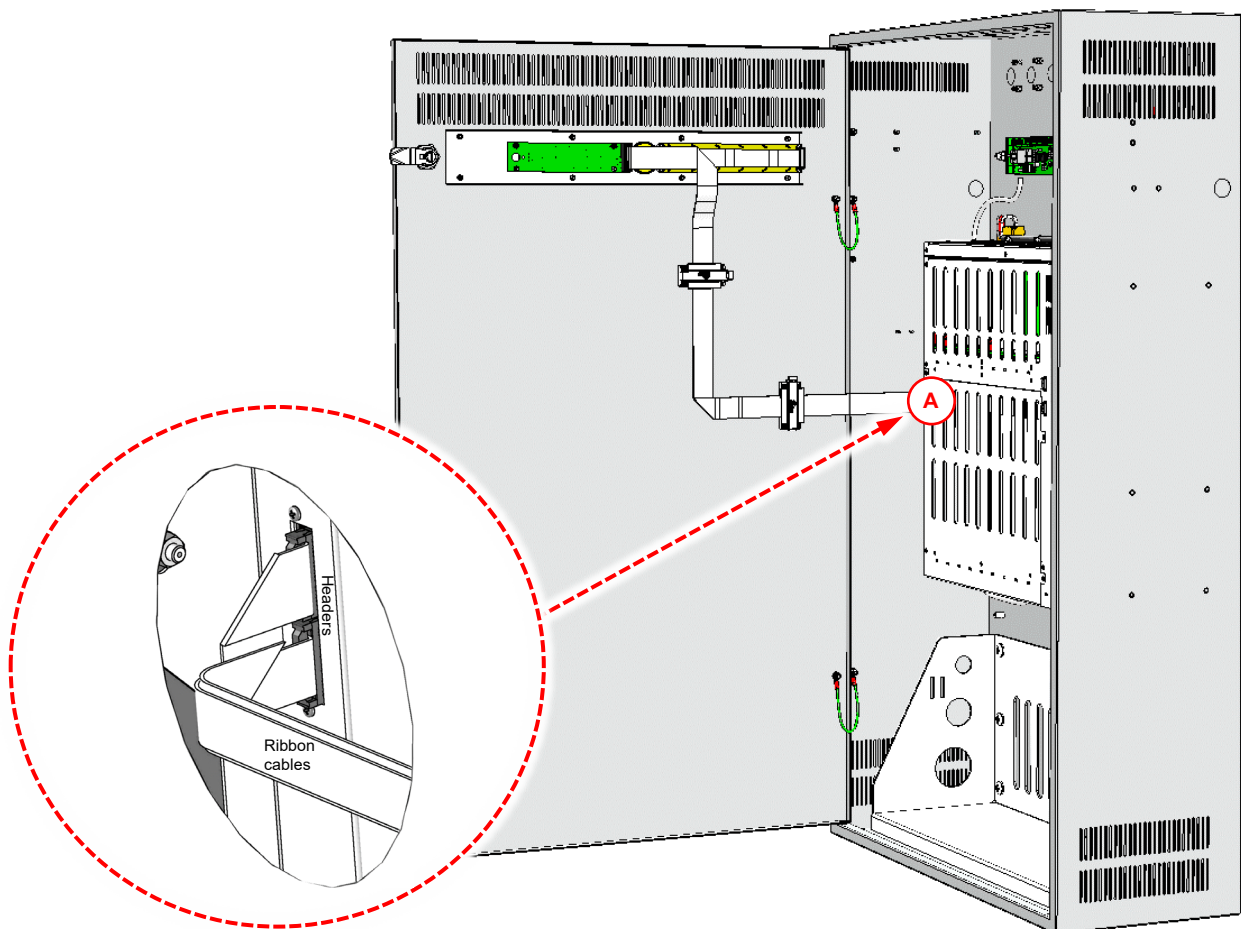

3. Disconnect the mains cable from the Electronics Module (A).
4. Disconnect the battery cable from the Electronics Module by undoing two strain-relief screws (B).
5. Disconnect the white power supply wiring from the Termination Board (C).
Do not disconnect the red power supply wiring from the Termination Board.
6. Disconnect the thermistor cable from the Electronics Module (D).

Undo
2 x captive
screws using a
small flat-blade
screwdriver

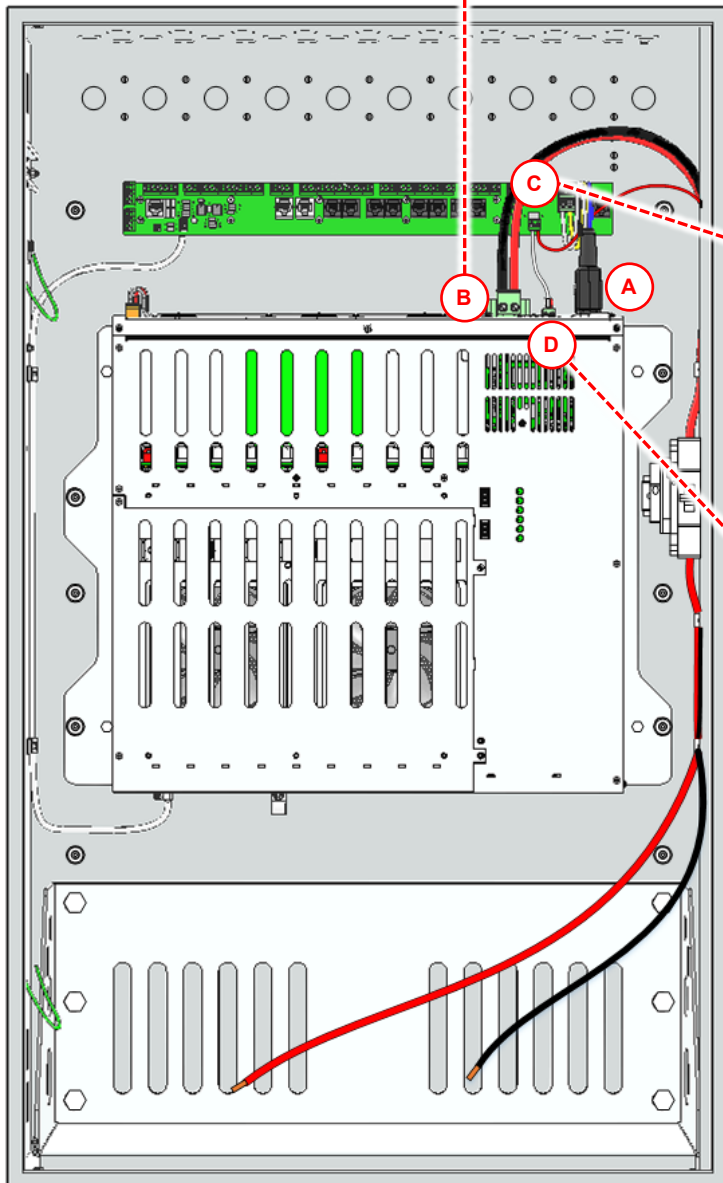
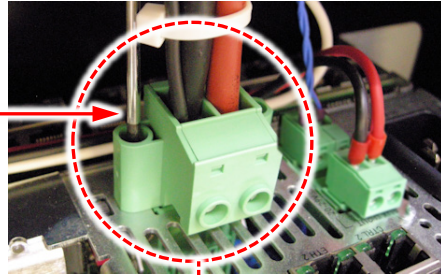

Disconnect
the WHITE
wiring only

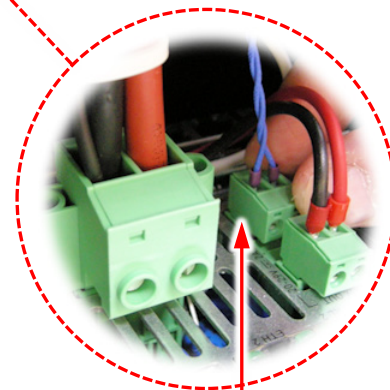
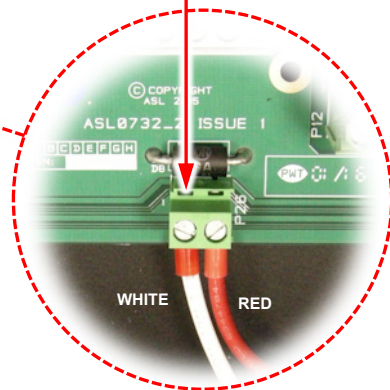

Thermistor
cable

7. If fitted, disconnect all patch leads (3 x yellow, 2 x blue and 10 x grey) from the Electronics Module (A).
8. Disconnect the red RJ45 patch lead from the Electronics Module (B).

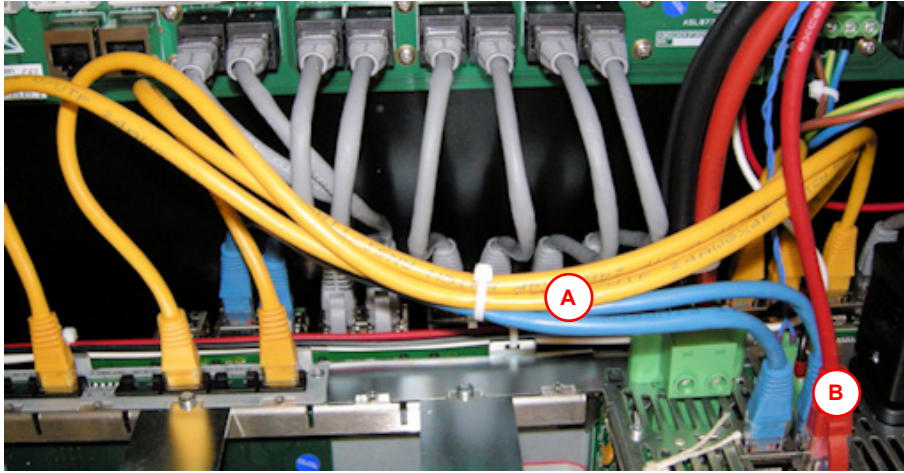

9. Remove the Electronics Module by:
 - a. Undoing 4 x M5 hex head transit screws (A).
 - b. Undoing 4 x M6 nuts (B).

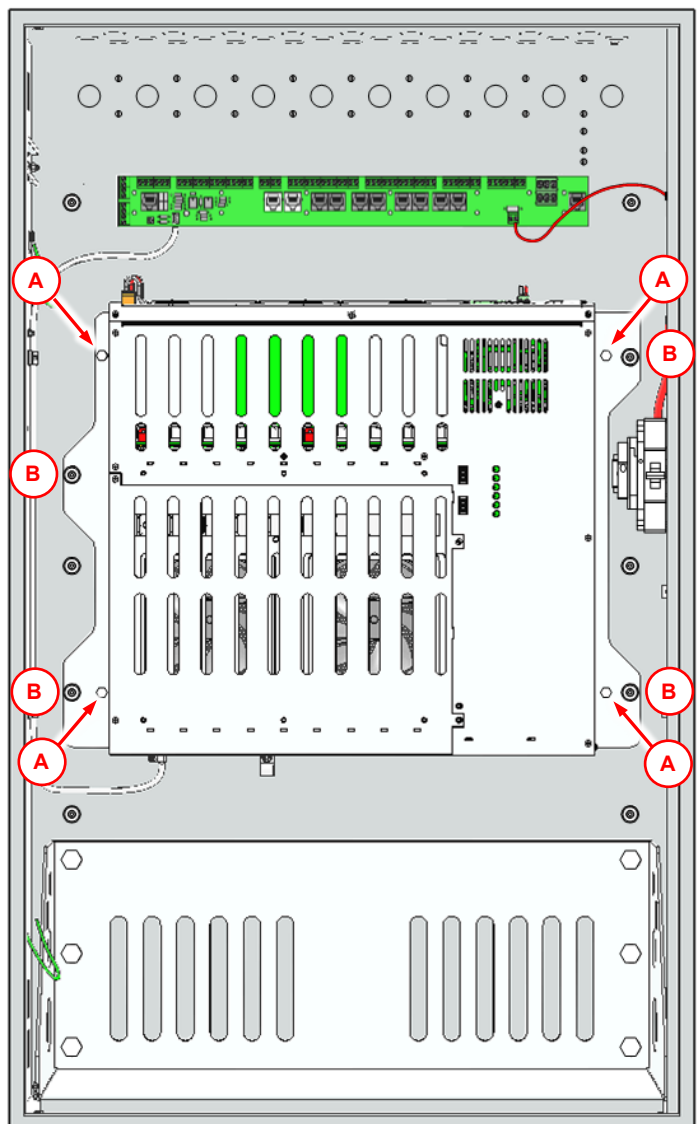

7.2 Configuring the Electronics Module



Note that the Electronics Module should be removed from the back box in order to perform some of the following steps.



The following diagrams show the Electronics Module removed from the back box and placed horizontally on a flat surface as these settings would normally be performed before the Electronics Module is fitted to the back box.

In case the settings are required to be performed with the Electronics Module fitted to the back box, use the bracket on the Electronics Module for location reference.

7.2.1 Fitting Memory Card(s)

If required, fit the memory card into the Micro-SD card slot (A):

- Carefully insert the memory card into the Micro-SD card slot (with the terminal side facing the amplifiers) until it clicks into place.
- Remove the memory card by lightly pushing the card once.



When inserting or removing the memory card, be careful to not drop the memory card.

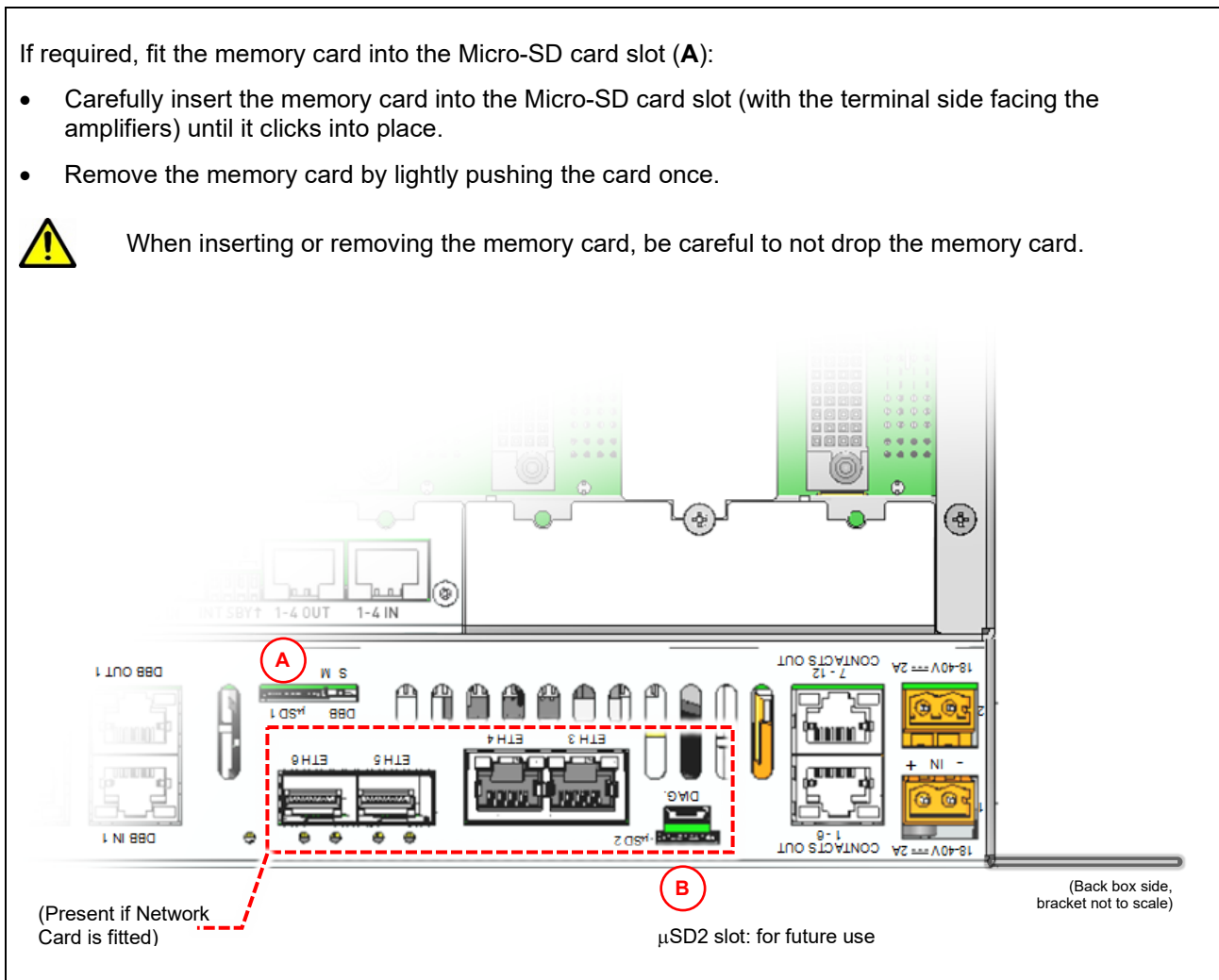

7.2.2 Fitting Small Form-Factor Pluggable (SFP) Transceiver Module(s) to the Network Card (if used)

If the unit is fitted with Network Card, fit the SFP module(s) as required.

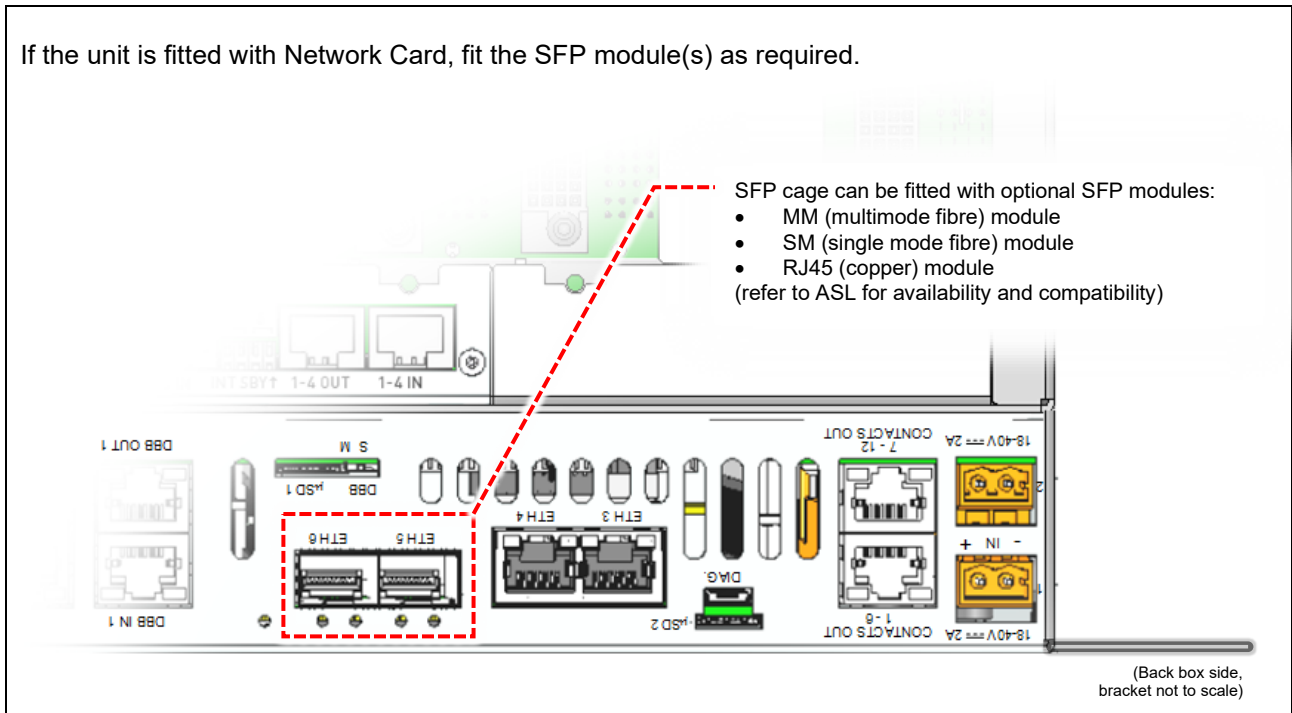

7.2.3 Setting the Earth Lift Switch

Set the rear-panel EARTH LIFT switch to the \perp (down, towards the back box) position as shown on the right.

Set the EARTH LIFT switch to the \ast (up) position to remove the mains earth from the signal circuit if a +ve ground battery system is used, or it is necessary to avoid a ground loop problem.



Never disconnect the mains earth from the plug to attempt to cure a ground loop. In the event of a fault, the equipment casing could become live.

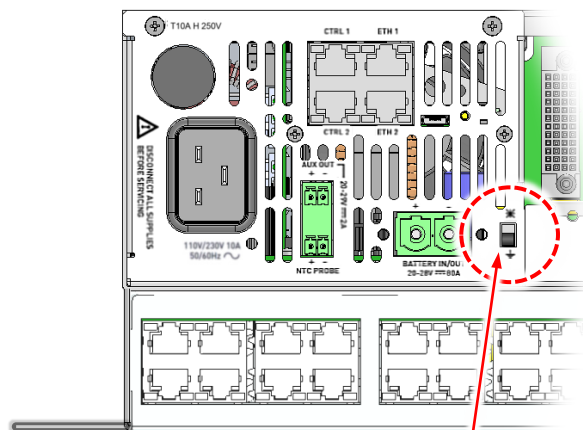

Earth Lift switch to \perp (down, towards the back box) (factory default).

7.2.4 Setting the DIP Switches on the Frame Controller

Ensure that all DIP switches on the Frame Controller board are set as shown below.

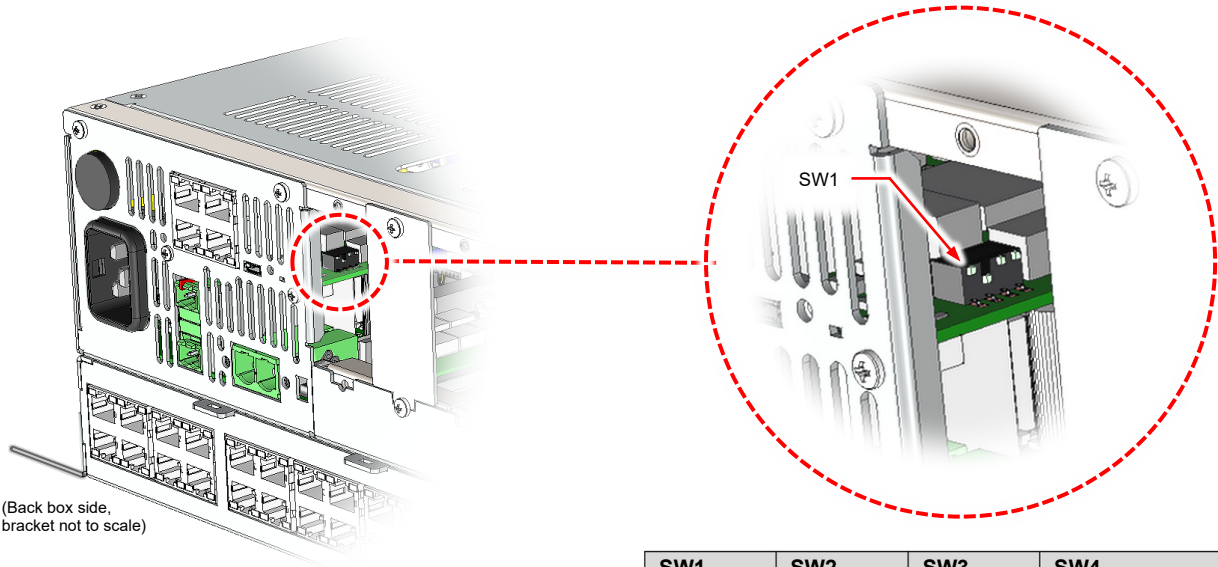

(Back box side,
bracket not to scale)

SW1	SW2	SW3	SW4
UP	DOWN	UP	UP
UP (OFF): towards the front door DOWN (ON): towards the back box			
DIP SW functions:			
<ul style="list-style-type: none"> • SW1 – DOWN enables the bootloader mode. • SW2 – DOWN sets the INTEGRA mode. • SW3 – DOWN disables mains fault monitoring. • SW4 – DOWN clears static and dynamic configuration. 			

7.2.5 Fitting an Interface Card/Amplifier Module and Setting the Standby Links



The following steps are not required for an INTEGRA that is pre-configured with all required modules (Interface Cards and amplifier modules).



The Electronics Module should be removed from the back box in order to install Interface Cards (LSZDC and/or V2000-STBY) and set the the standby amplifier links.

Refer to Section “7.1 Removing the Electronics Module (if required)” (page 28).



The bottom cover must be removed in order to fit or remove an amplifier module. The top cover (L-shaped) should be removed to fit a LSZDC Interface Card or set the standby links.

7.2.5.1 Removing the Top and Bottom Covers

Remove the bottom cover by undoing 4 x M3 screws, and then remove the top (L-shaped) cover by undoing 10 x M3 screws.

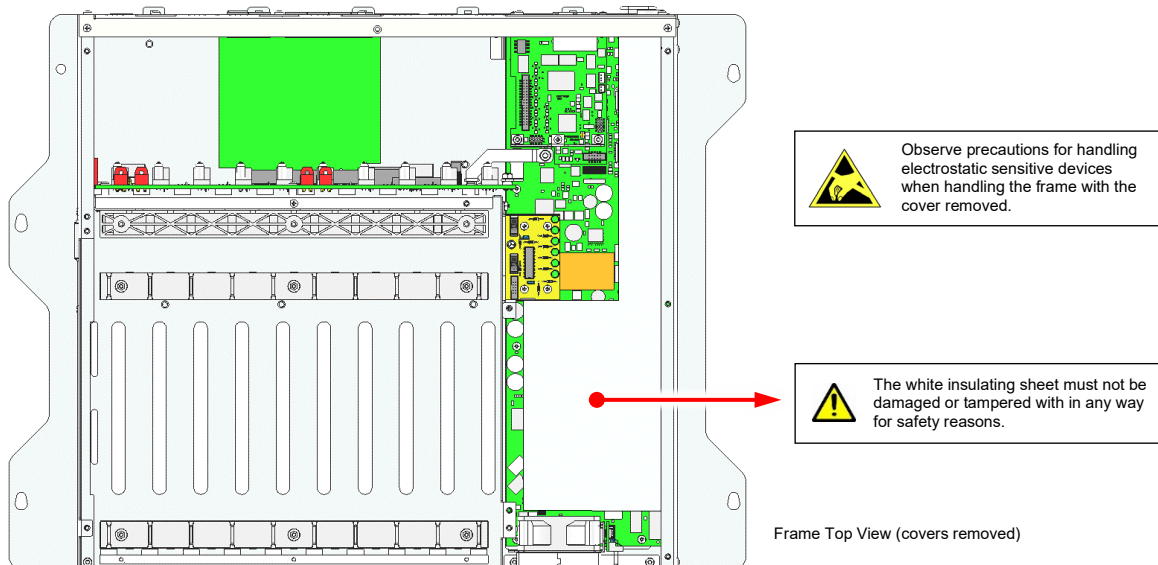
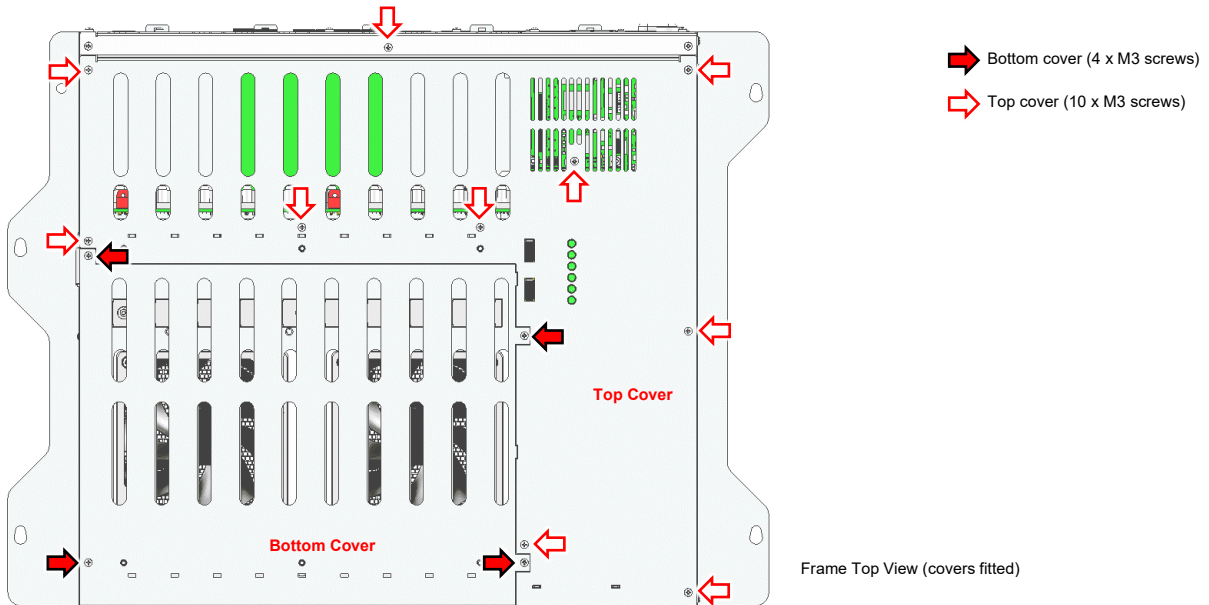

7.2.5.2 Removing the Surveillance Blanking Plates

Remove all Surveillance Blanking Plates from the rear panel by undoing 2 x screws.

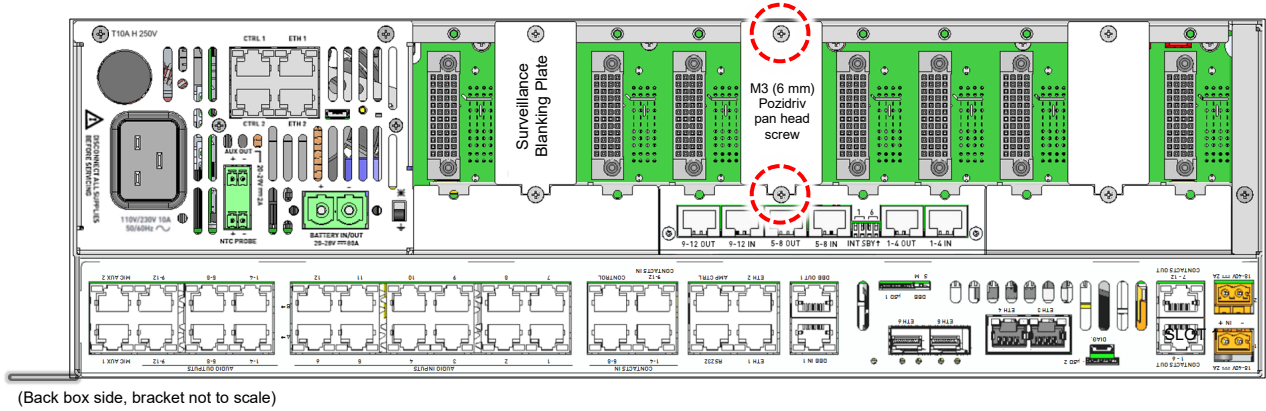

7.2.5.3 Fitting a V2000-STBY Interface Card

1. If used, fit a V2000-STBY Interface Card to the rear panel standby interface card slot as required by your system design.



If a single V2000-STBY Interface Card is to be fitted to an INTEGRA, it is normally fitted to the left-hand side standby interface card slot (for standby amplifier fitted into slot 6) as illustrated below.

2. Remove the Standby Blanking Plate from the required interface card slot.

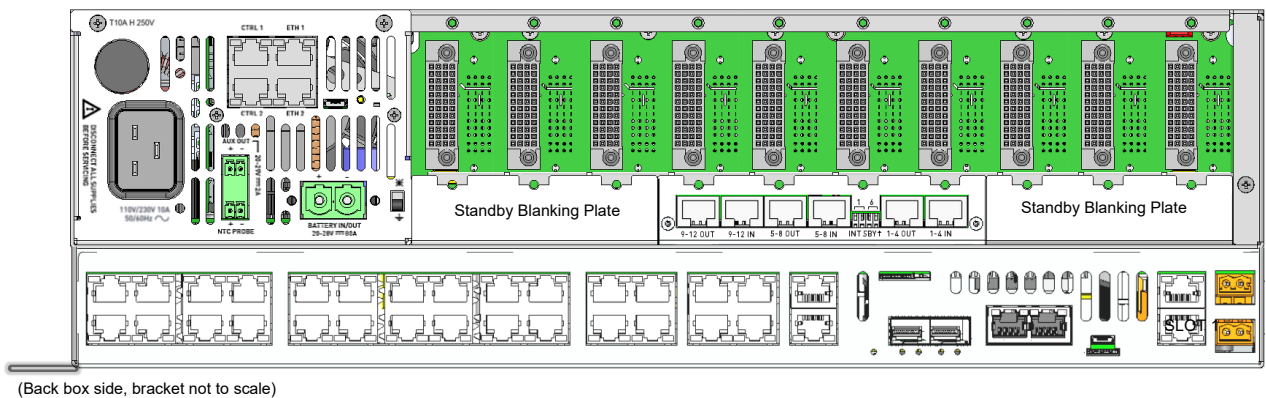

- Insert the V2000-STBY Interface Card so that its contacts line up with the matching connector on the backplane.

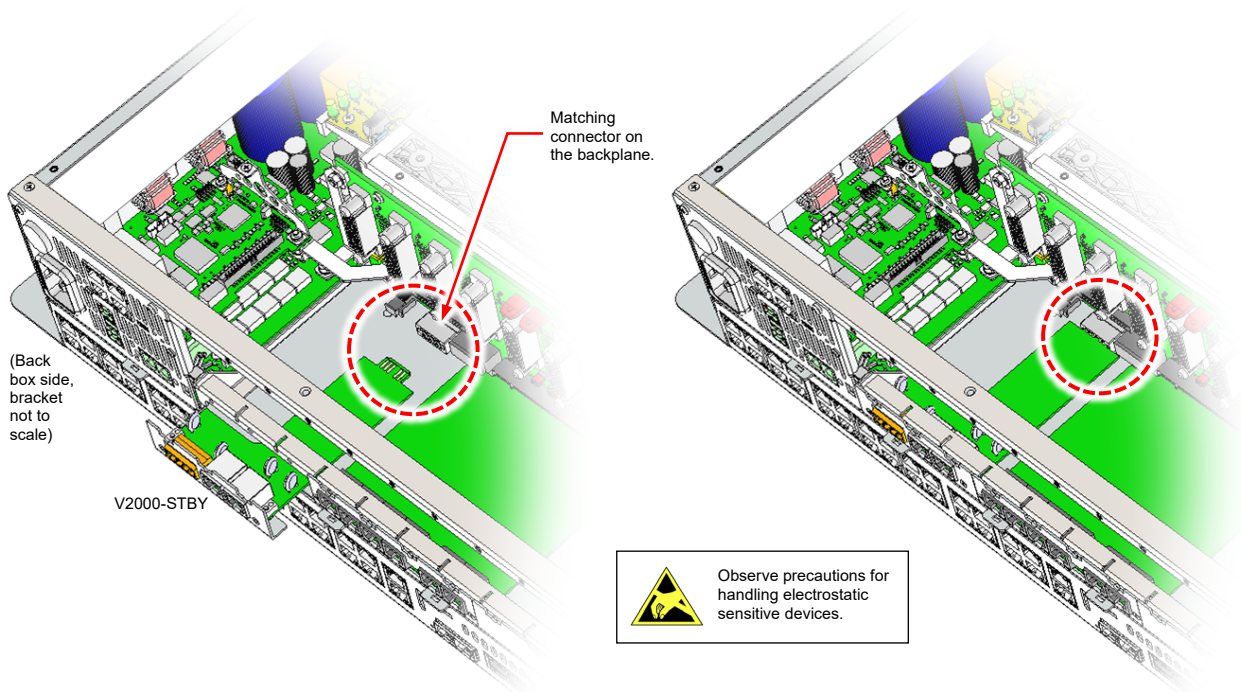

- Ensure that the interface card is fully pushed.



Do not fit the top 3 x screws as they are used to secure the LSZDC Surveillance Interface Card (or the Surveillance Blanking Plate).

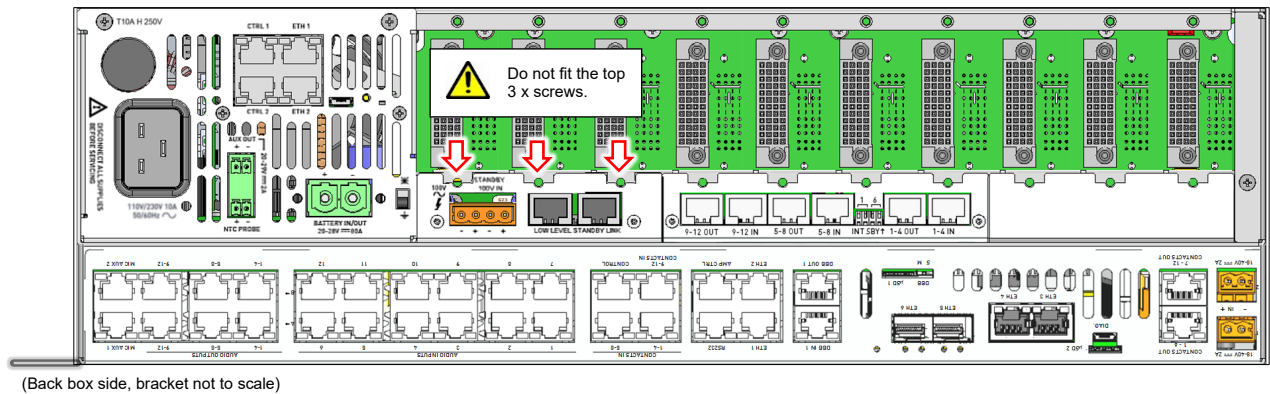

- If used, repeat the above procedure for the second V2000-STBY Interface Card.

7.2.5.4 Setting the Standby Amplifier Links

Set the standby amplifier links on the rear side of the backplane as required.



Ensure that the standby links are correctly set on the amplifier frame backplane. If incorrectly set, amplifiers may be damaged when a standby amplifier changes over.

1. Single standby amplifier (slot 1): No V2000-STBY Interface Card fitted

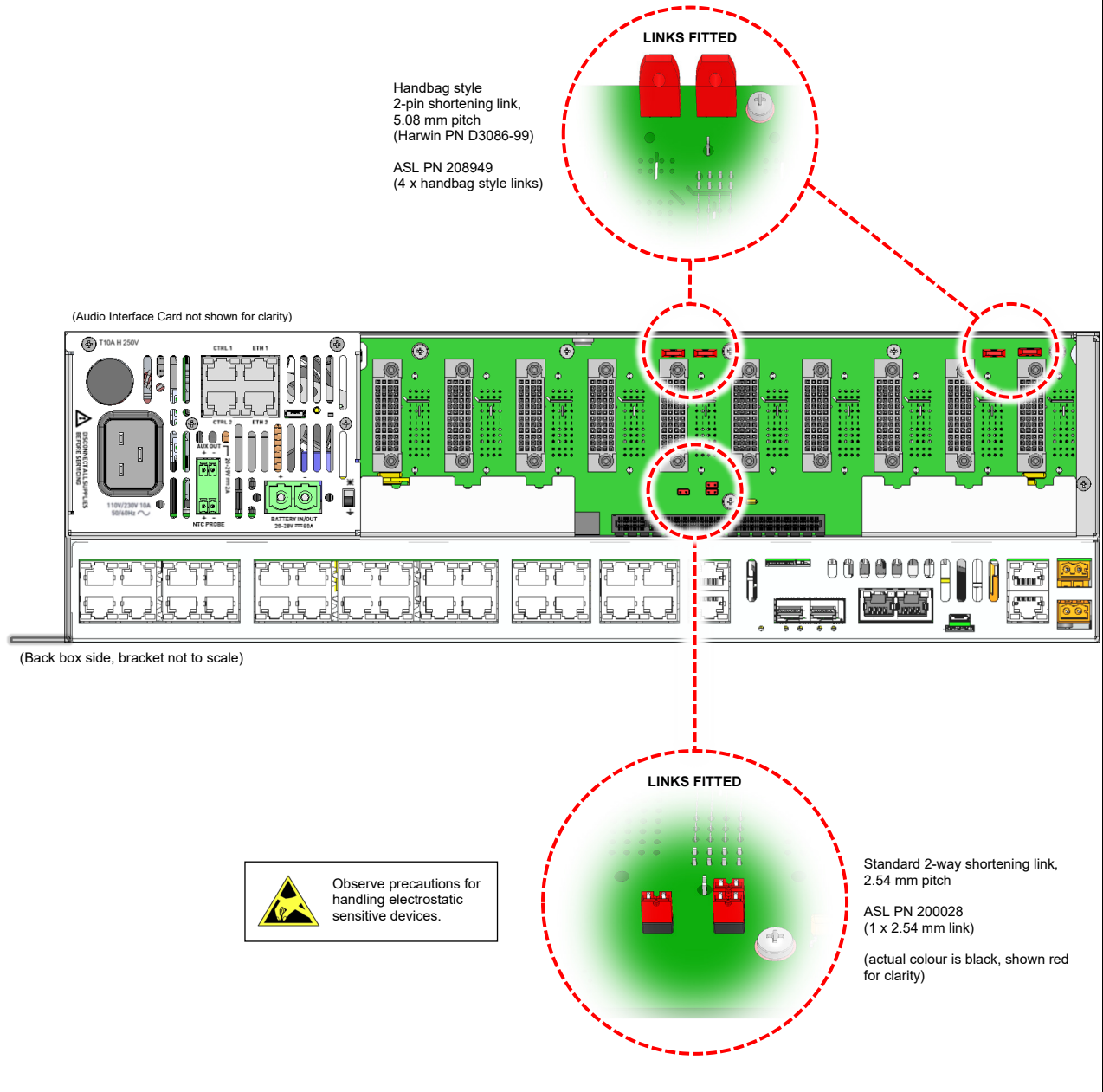

2. Dual standby amplifiers (slot 1 and slot 6): 1 x V2000-STBY Interface Card fitted to the left-hand side standby slot:

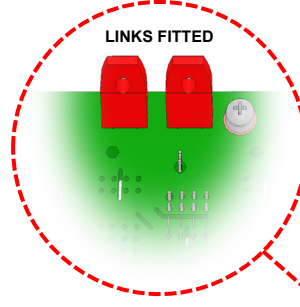
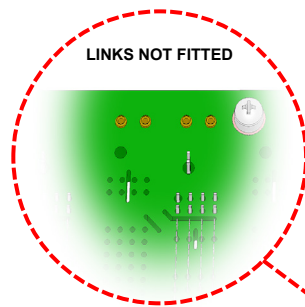

Handbag style
2-pin shortening link,
5.08 mm pitch
(Harwin PN D3086-99)

ASL PN 208949
(4 x handbag style links)

(Audio Interface Card not shown for clarity)

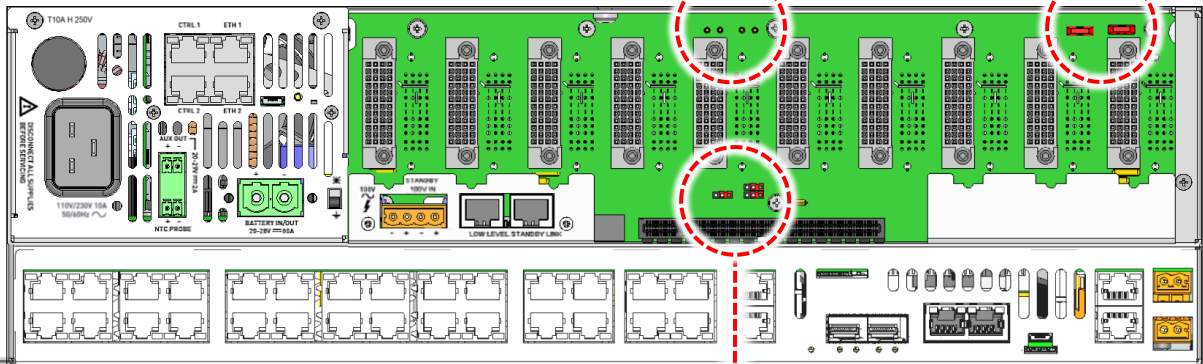

(Back box side, bracket not to scale)

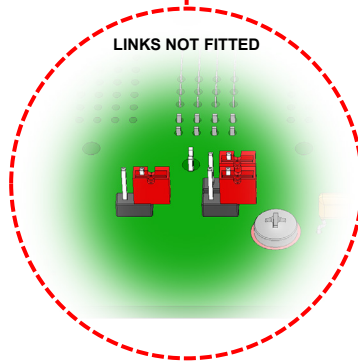

Standard 2-way shortening link,
2.54 mm pitch

ASL PN 200028
(1 x 2.54 mm link)

(actual colour is black, shown red
for clarity)

Observe precautions for
handling electrostatic
sensitive devices.

7.2.5.5 Fitting Blanking Plates

Cover all unused slots with a Blanking Plate as specified in your system design:

1. Standby Blanking Plate (ASL PN M0623_08) (A):

The blanking plate is secured by the screws securing either a LSZDC or a Surveillance Blanking Plate.

The example below shows a blanking plate covering the right-hand side standby interface card slot.

2. V2000 Surveillance Blanking Plate ASL PN V2000-RBLANK (B):

Secure the blanking plate(s) using 2 x screws.

The example below shows a blanking plate covering slots 2, 4, 5, 7, 9 and 10.



Any blanking plates removed from the INTEGRA as part of the installation process ideally should be recycled as metal or otherwise responsibly disposed of by following WEEE protocols.

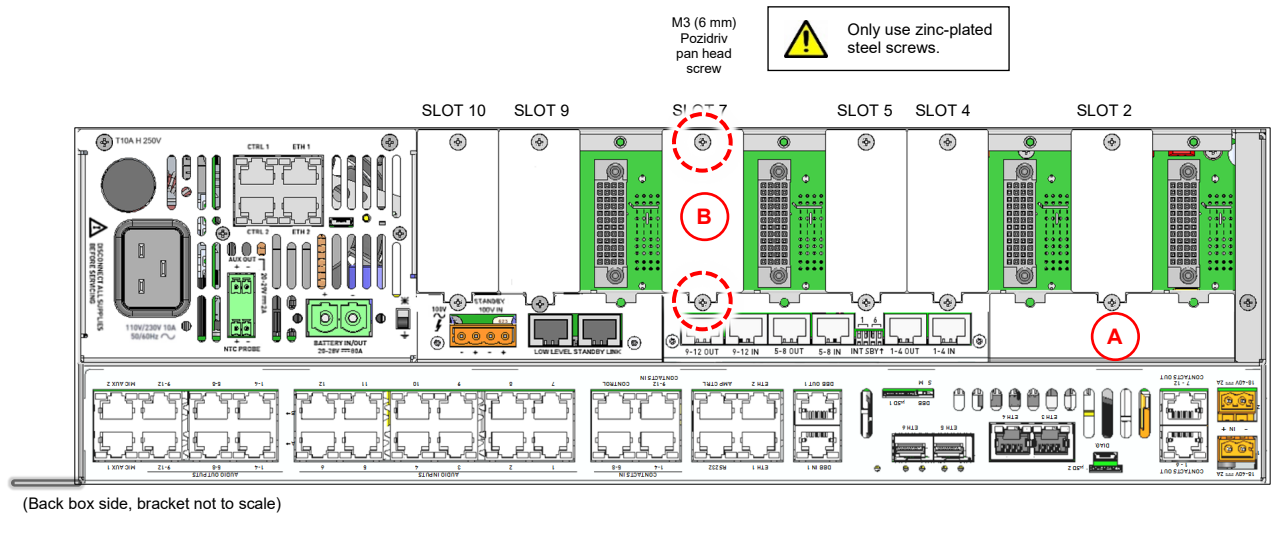

7.2.5.6 Fitting a LSZDC Interface Card

1. Fit the LSZDC Interface Cards to the rear panel surveillance interface card slots as required by your system design.

The illustrations below show a LSZDC Interface Card being fitted into slot 1.

2. Insert the LSZDC Interface Card so that its rear connector mates the matching connector on the backplane by seating the tab at the bottom of the interface card in the appropriate notch on the interface card support.

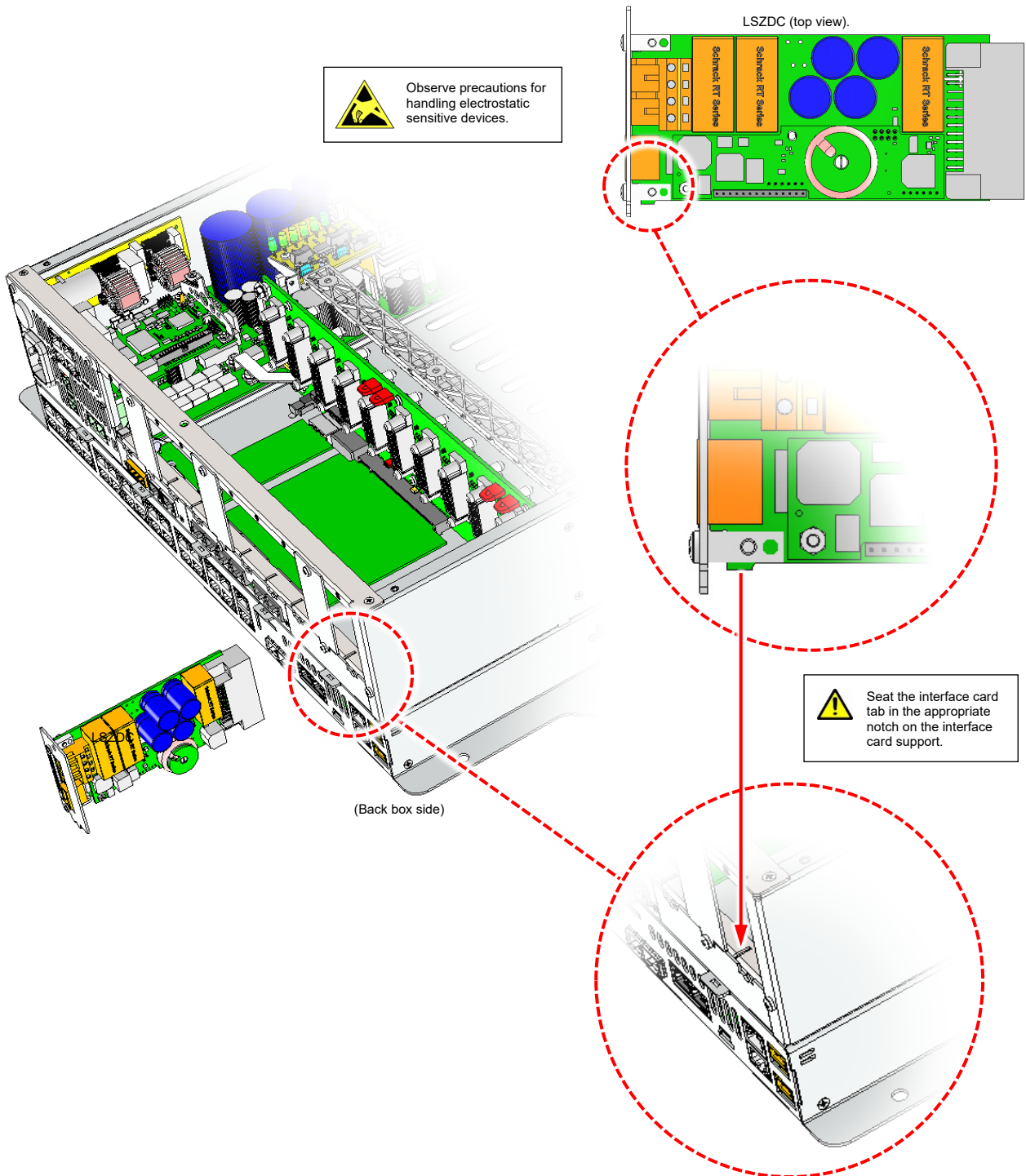

- Ensure that the interface card is fully pushed home, and then secure it using 2 x screws.



Ensure that all securing screws are fully tightened to bond the interface card to the amplifier frame chassis. It is important to make sure that the screws are fully tightened to prevent dangerous voltages being present on the panel.

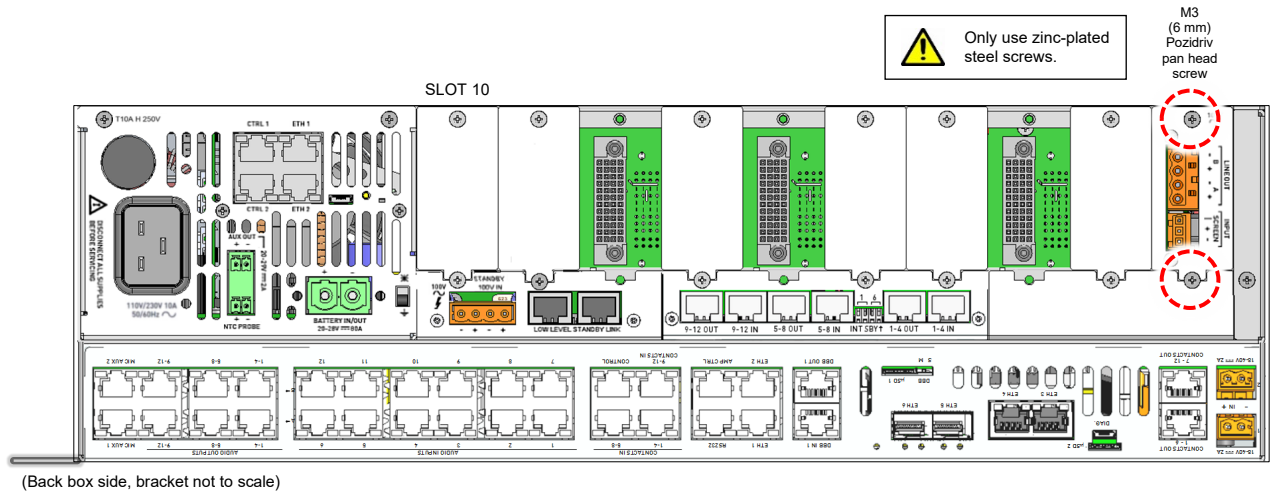

- Repeat the procedure for the remaining LSZDC Interface Cards.

7.2.5.7 Installing an Amplifier Module

Install the amplifier modules as required by your system design.

1. Fully open the ejector lever of the amplifier module.
2. Position the amplifier module in the slot and align the bottom side of the module with the card guide to locate it correctly.

3. Carefully slide the amplifier module into the slot until the ejector lever meets the card guide at the bottom.
4. Pivot the ejector lever up just so that the ejector lever hook fits into the gap between the card guide and the card ejector restraining bar.

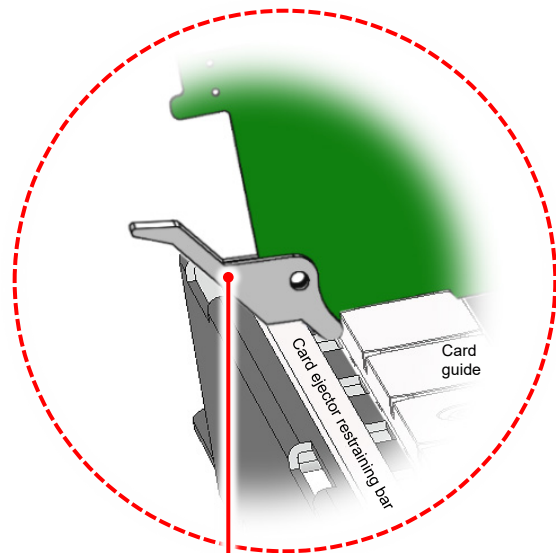

 Ejector lever hook fitted into the gap between the card guide and card ejector restraining bar.

5. Pivot the ejector lever up to fully seat the amplifier module in the frame backplane connector.
-  Do not force the ejector lever up if the ejector lever hook is not fitted in the gap between the card guide and the card ejector restraining bar as this may damage the connectors. If required, re-insert the amplifier module.

7.2.5.8 Fitting the Top Cover to the Electronics Module

1. If removed, fit the top cover (L-shaped) to the Electronics Module.



Ensure that all tools and swarf are removed from the frame case before re-fitting the cover.

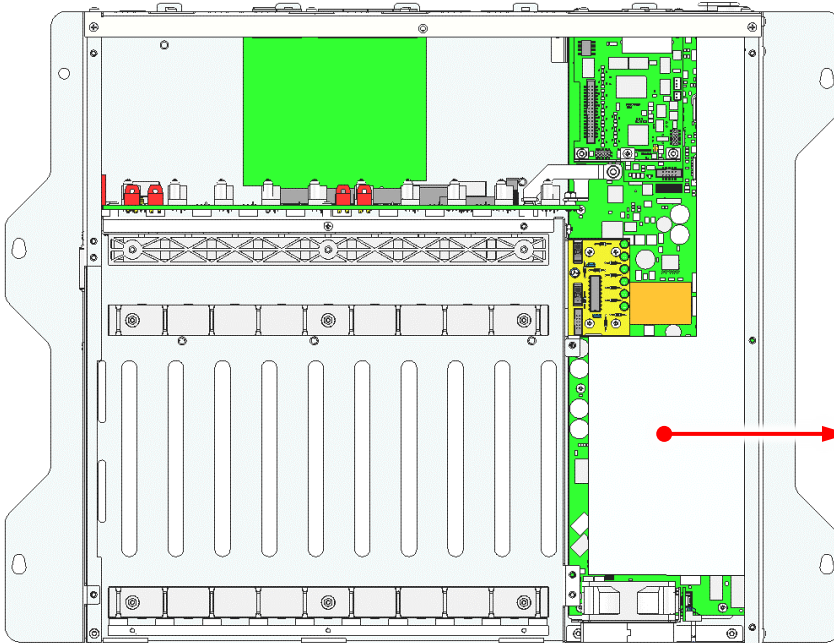

 Observe precautions for handling electrostatic sensitive devices when handling the frame with the cover removed.

 The white insulating sheet must not be damaged or tampered with in any way for safety reasons.

Frame Top View (covers removed)

2. First engage the joggled end under the rear brace as shown, then lower the cover into place. This ensures that the switch holes locate neatly over the switches without damaging them.

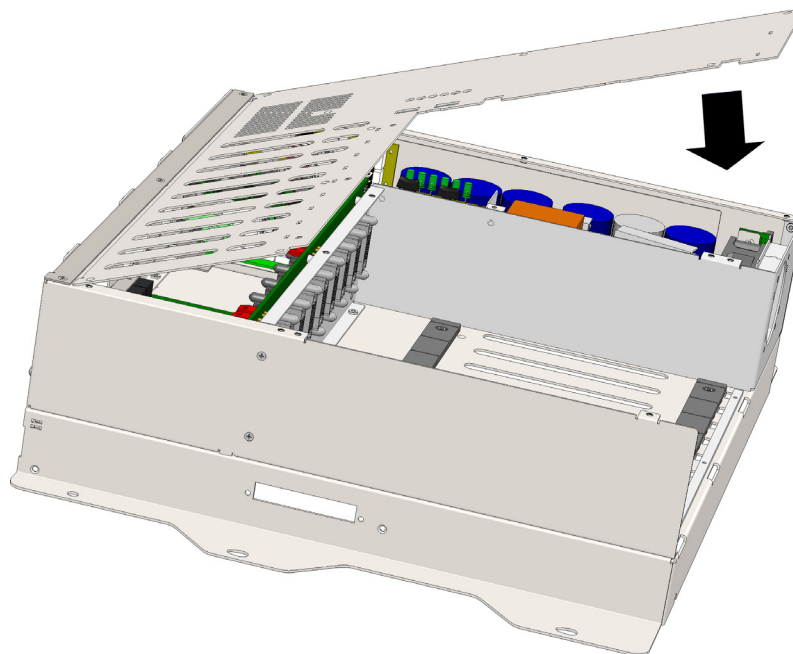

3. Secure the cover using 10 x M3 screws.

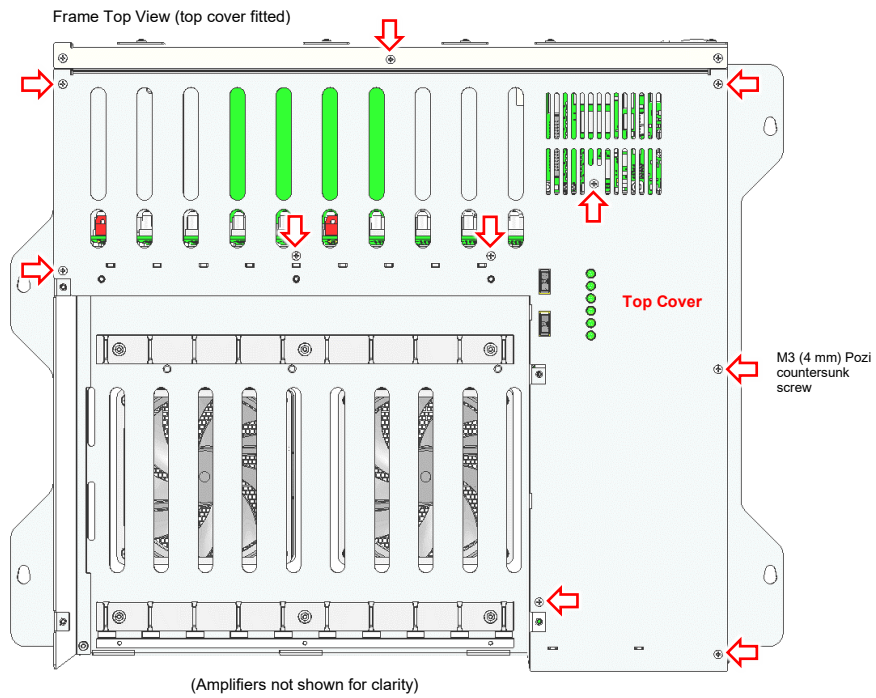

7.2.5.9 Fitting the Bottom Cover to the Electronics Module

1. If removed, fit the bottom cover to the Electronics Module.



Ensure that all tools and swarf are removed from the frame case before re-fitting the cover.

2. Lower the cover into place as shown below, engaging the three joggled tabs along its bottom edge with the corresponding slots in the base.

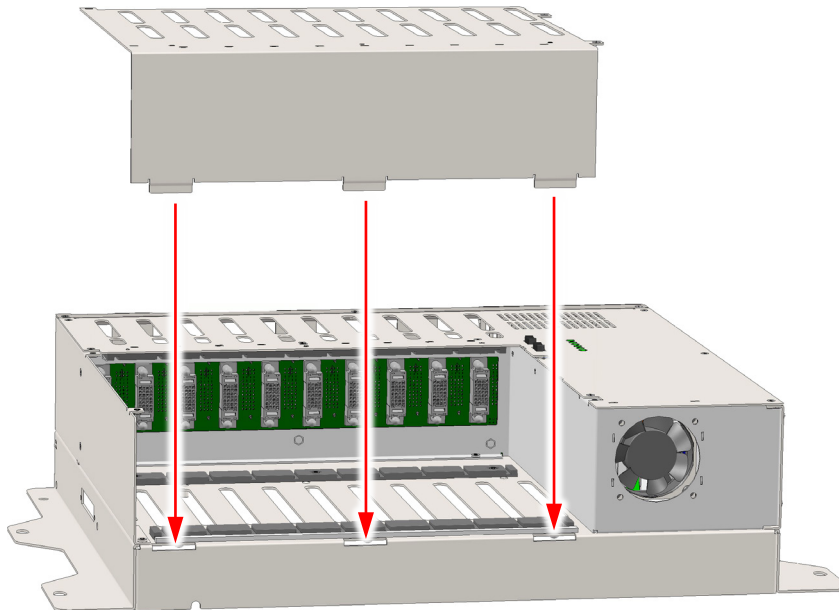

3. Secure the cover using 4 x M3 screws.

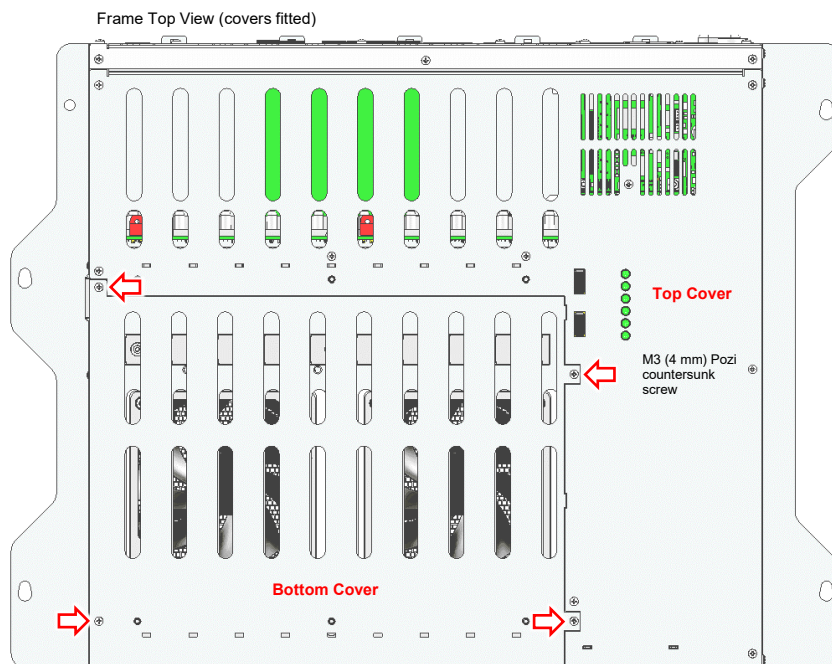

7.2.6 Setting the Internal Standby DIP Switches

Set the INT SBY switches on the Audio Interface Card as required by your system design.



Ensure that the standby DIP switches are correctly set.

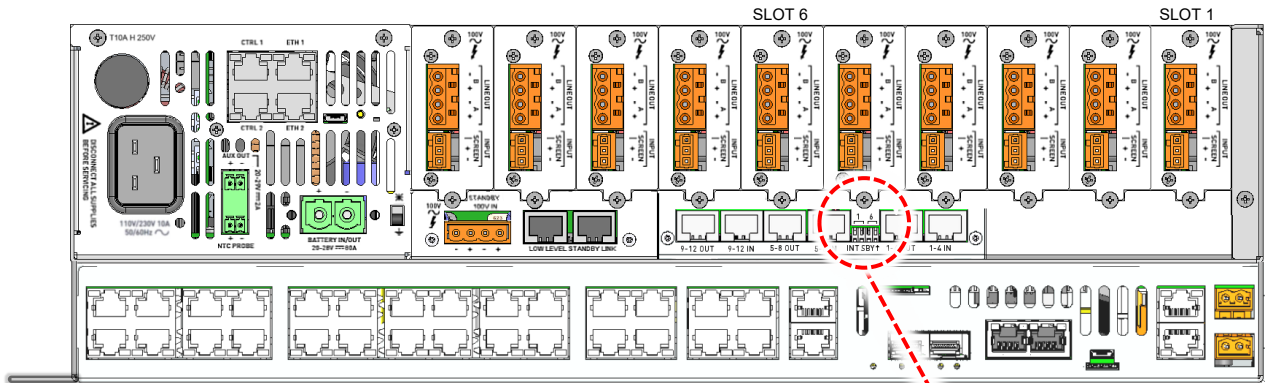

(Back box side, bracket not to scale)

SZDC and V2000-STBY shown as example only

INT SBY Switches	Amplifier Slot	Amplifier Type	INT SBY Switch Position
1	Slot 1	Working	DOWN (towards the back box)
		Standby	UP (towards the front door)
		Not fitted	Any
6	Slot 6	Working	DOWN (towards the back box)
		Standby	UP (towards the front door)
		Not fitted	Any



7.3 Fitting Expansion DIN Rail Support Brackets (optional)

You will need:

An Expansion DIN Rail and mounting kit (ASL INTEGRA-DIN-KIT)

1. Remove the DIN rail fitted to the top left-hand side of the back box by undoing 2 x M4 nuts (**A**).



The DIN rail removed from the INTEGRA as part of the installation process ideally should be recycled as metal or otherwise responsibly disposed of by following WEEE protocols.

(Other components and wiring not shown for clarity)

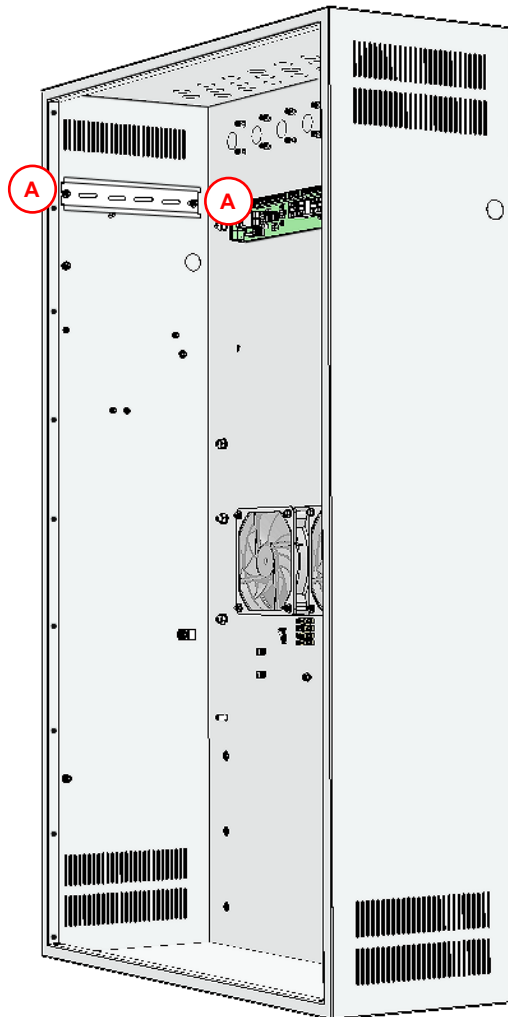

2. Secure a DIN rail support bracket to the studs on both sides of the back box using 2 x M4 nuts and washers (A).

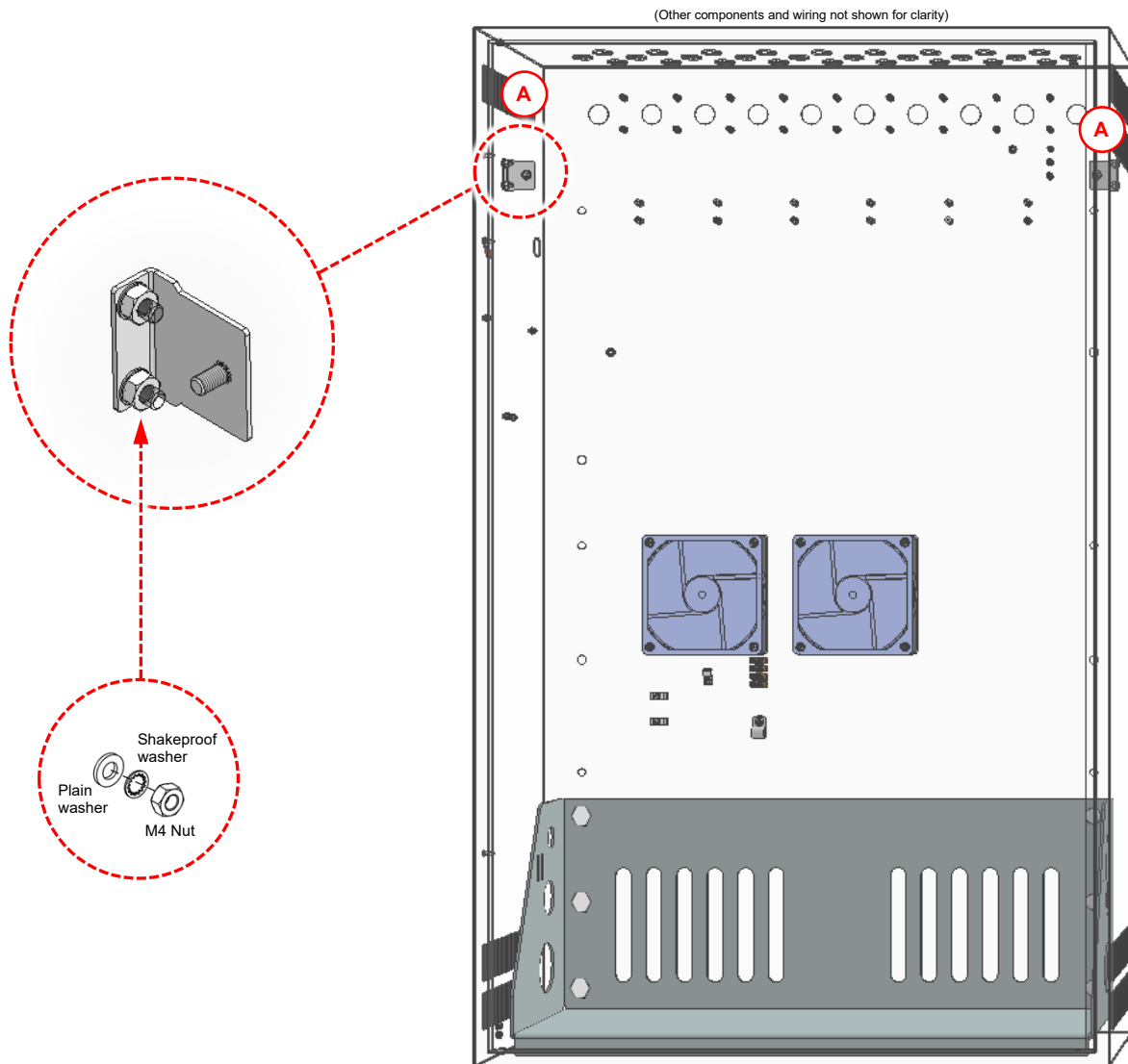

3. The Expansion DIN Rail should be fitted after connecting the field wiring to the termination board and amplifiers as described in Section “7.15 Fitting an Expansion DIN Rail (optional)” (page 76).

7.4 Fitting a Hirschmann Network Switch (if required)



The Electronics Module should be removed in order to install a Network Switch.

You will need:

- A Network Switch (ASL NETWORK-SWITCH-MM4 or NETWORK-SWITCH-MM4)
- A Network Switch mounting kit (ASL INTEGRA-SWITCH-MOUNT)
- A CAT5 patch lead (300 mm)
- Wiring as specified in Section “8.6 Hirschmann Network Switch Connection to INTEGRA” (page 114)

Note:

INTEGRA-PRO units may be supplied with the required wiring and a CAT5 patch lead.

1. Secure the Network Switch bracket to the pair of studs on the left-hand side of the back box using 2 x M3 nuts and washers (A). Do not tighten the nuts.

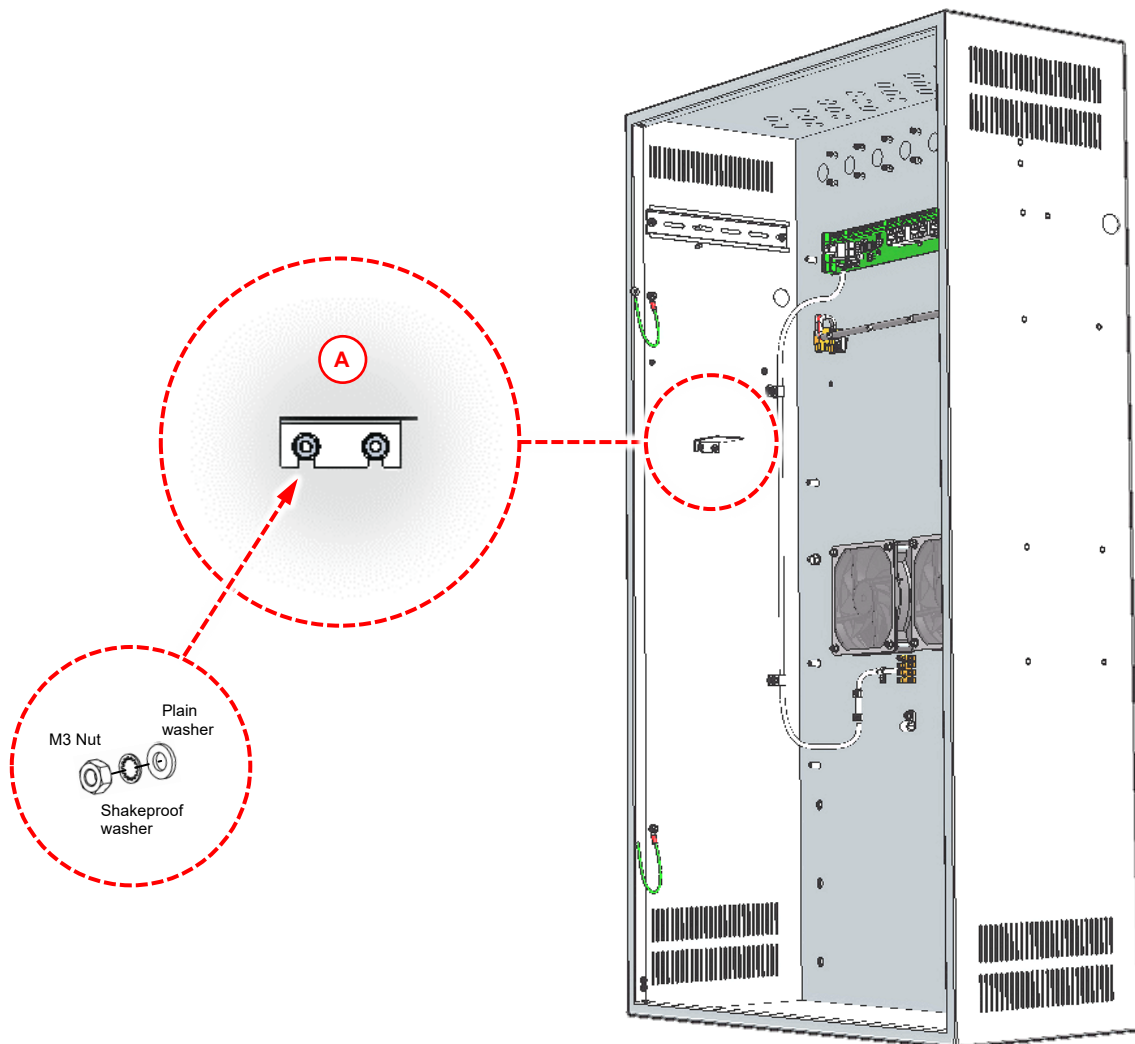

2. Attach the upper snap-in guide of the Network Switch into the bracket.
3. Pull the locking slide out and press the Network Switch down against the bracket until it snaps into place as shown below.

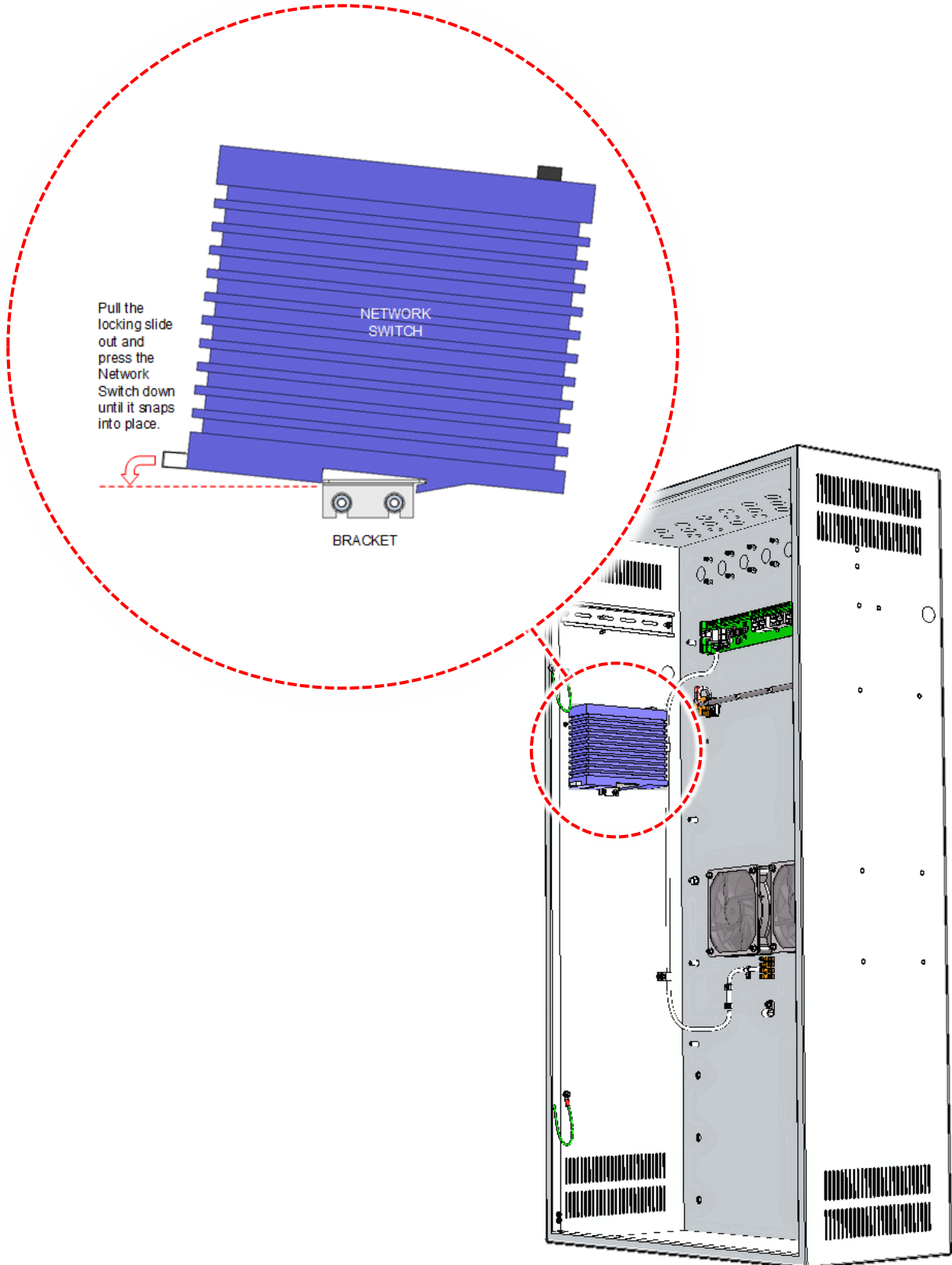

4. Fit the clamps to the top slots on the Network Switch as shown below, and then secure the clamps to the studs on the back box using M3 nuts and washers (A). Tighten the nuts.
5. Tighten the nuts securing the bottom bracket (B).

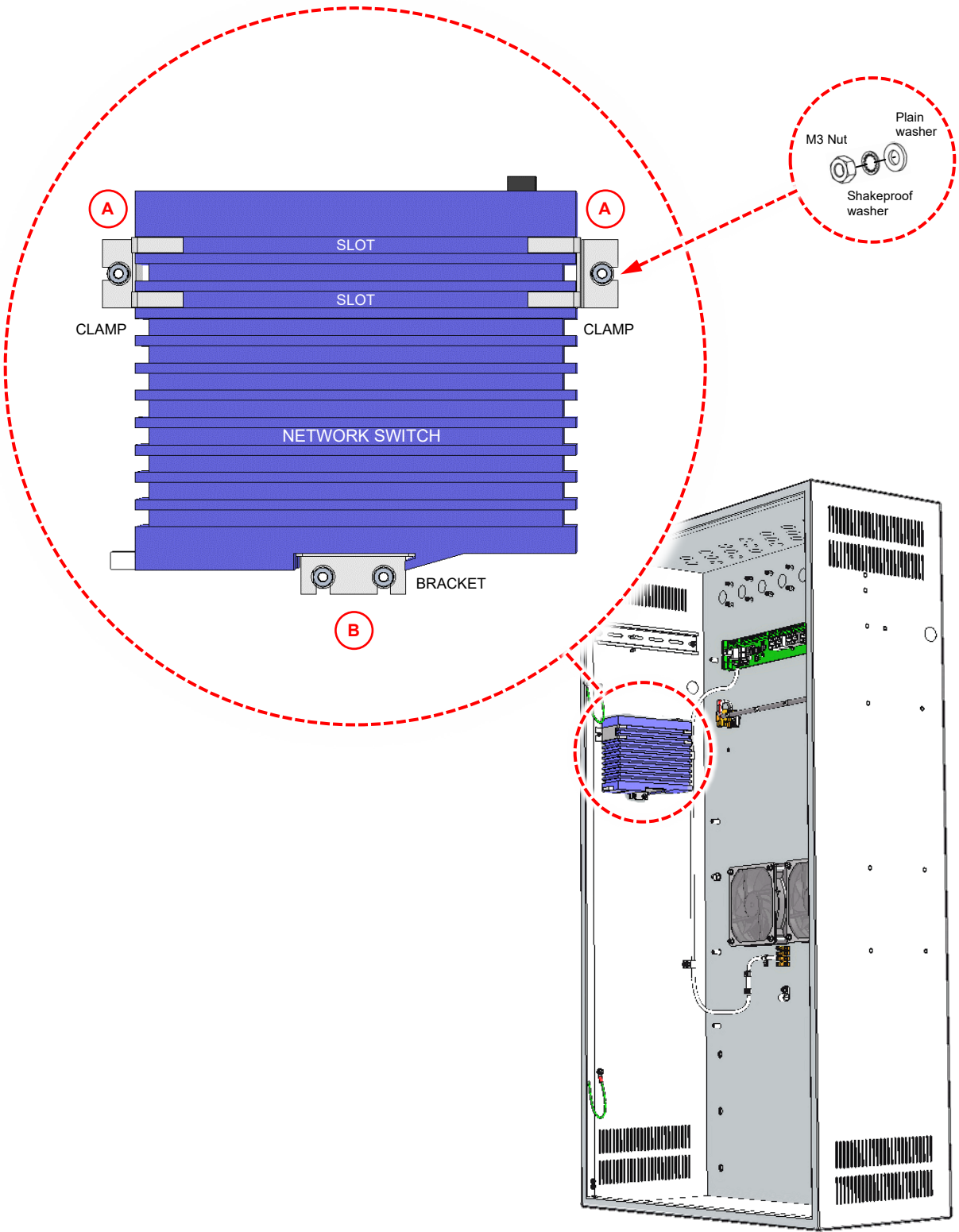

6. Connect the power supply and fault contact wiring from the Network Switch to the Termination Board (A).

Notes:

- 1) INTEGRA-PRO units may be supplied with required power supply and fault contact wiring.
- 2) The image on the next page shows the Network Switch fitted and wired to the Termination Board.

(Network Switch and wiring not shown for clarity)

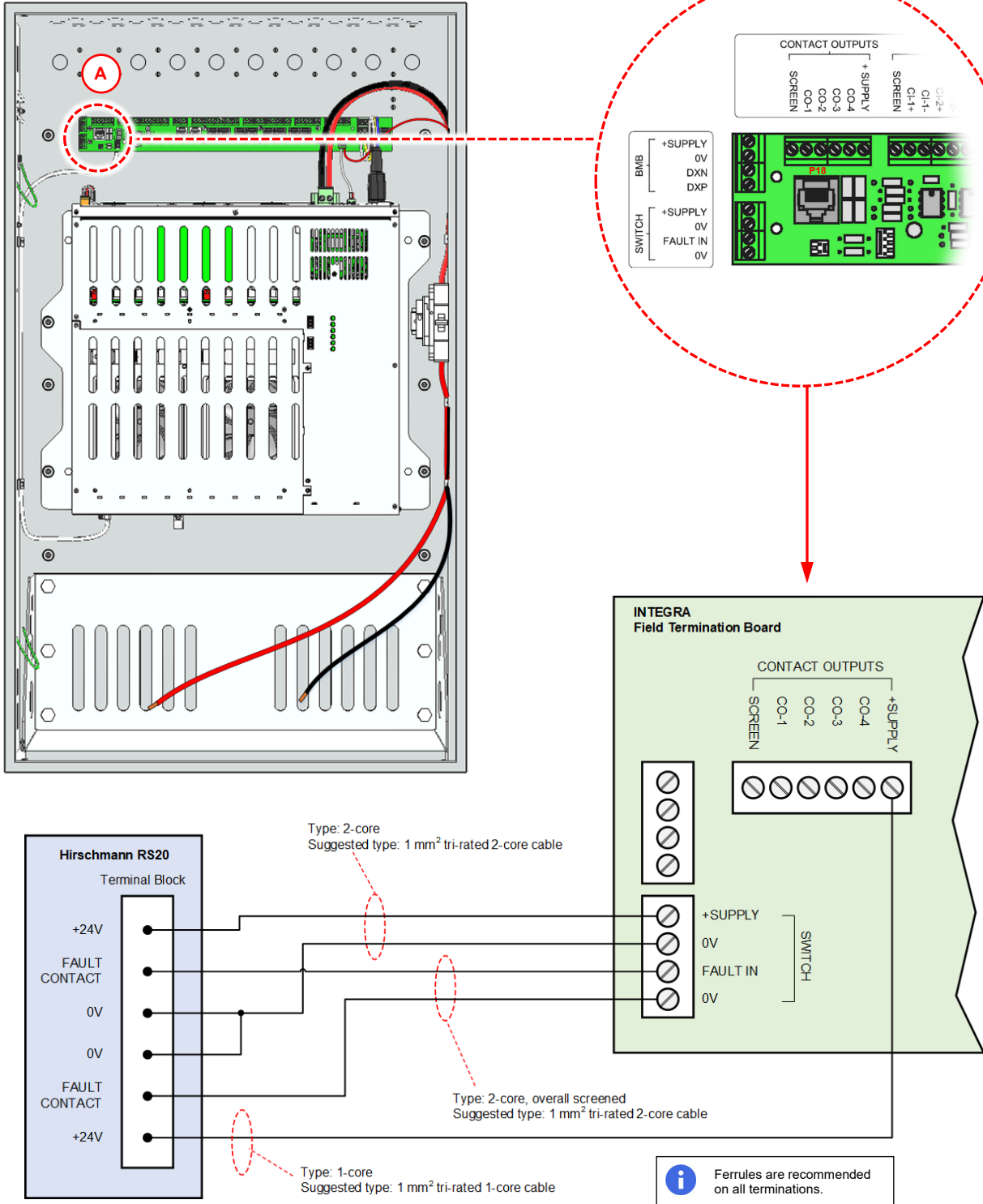

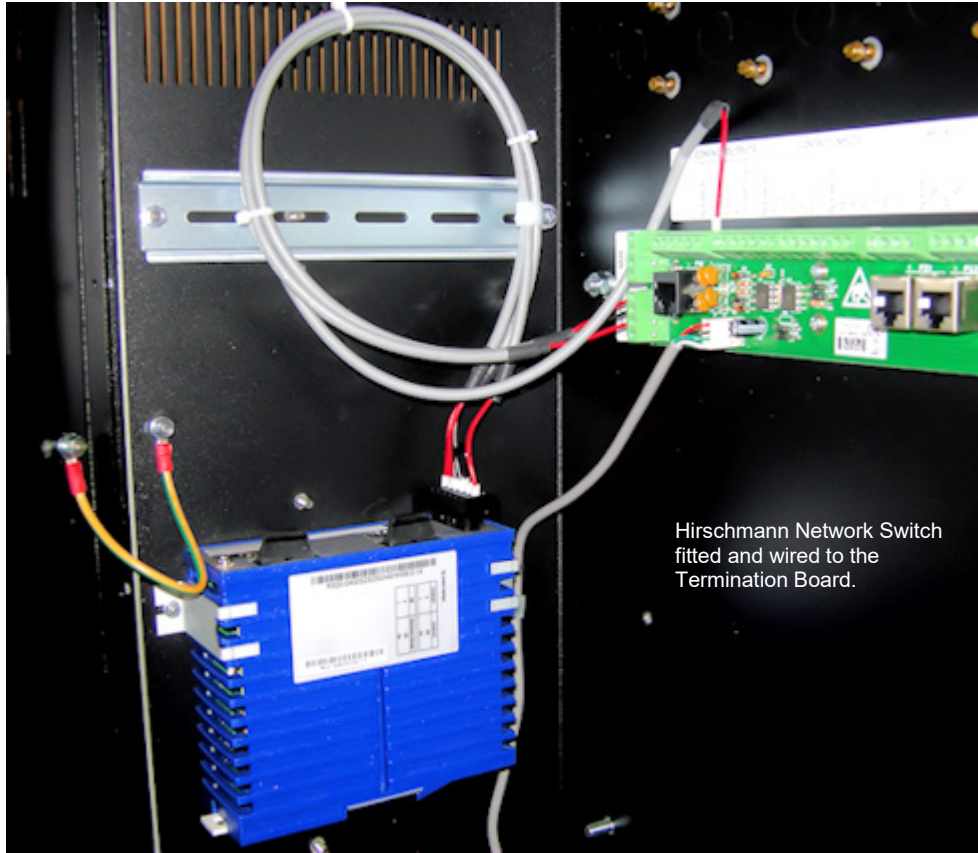



Hirschmann Network Switch fitted and wired to the Termination Board.

7.5 Removing the Wall-Mount Frame

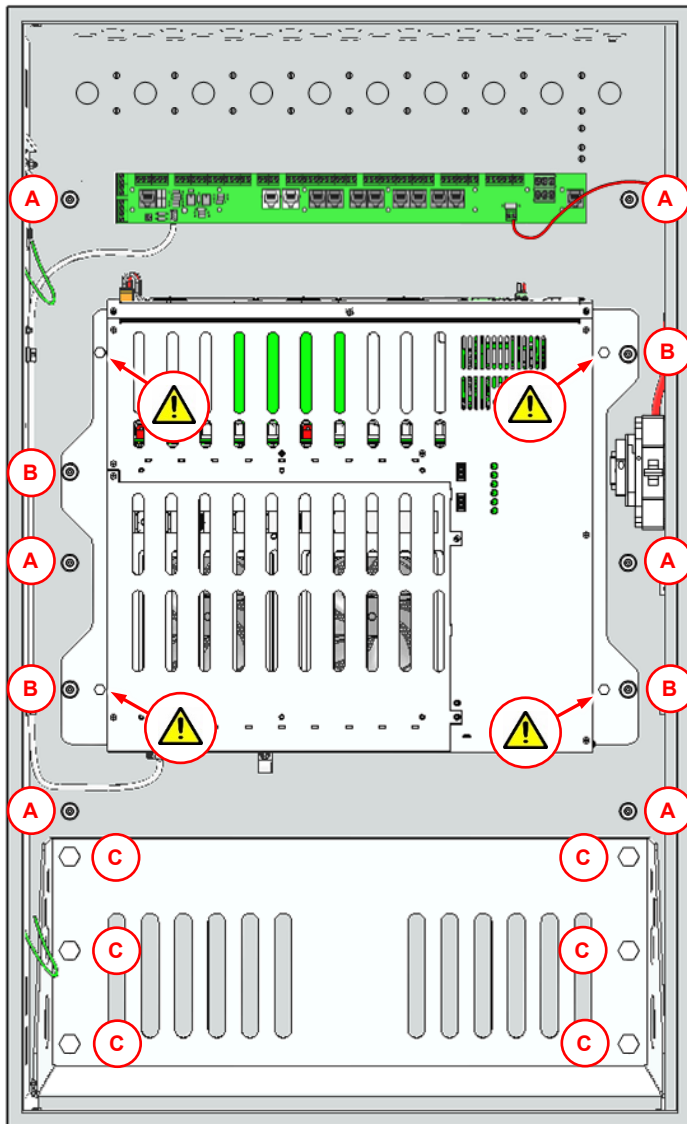
1. Undo 6 x M6 nuts (**A**) securing the back box to the wall-mount frame.
2. Undo 4 x M6 nuts (**B**) securing the Electronics Module to the wall-mount frame (if not already done).
3. Undo the 6 x M8 hex head screws securing the battery tray to the back box and wall-mount frame (**C**).



 Do not remove the transit screws if not removing the Electronics Module.

7.6 Installing the Wall-Mount Frame



The INTEGRA is heavy (max. > 95 kg) and it is VITAL that it is mounted to suitably robust walls or structures using appropriate fixing for the specific wall type.

1. Prepare the wall-mount holes appropriately using the wall-mount frame to mark the hole positions (shown below).
2. Secure the wall-mount frame to the wall.



Ensure that the frame is correctly oriented as shown below.

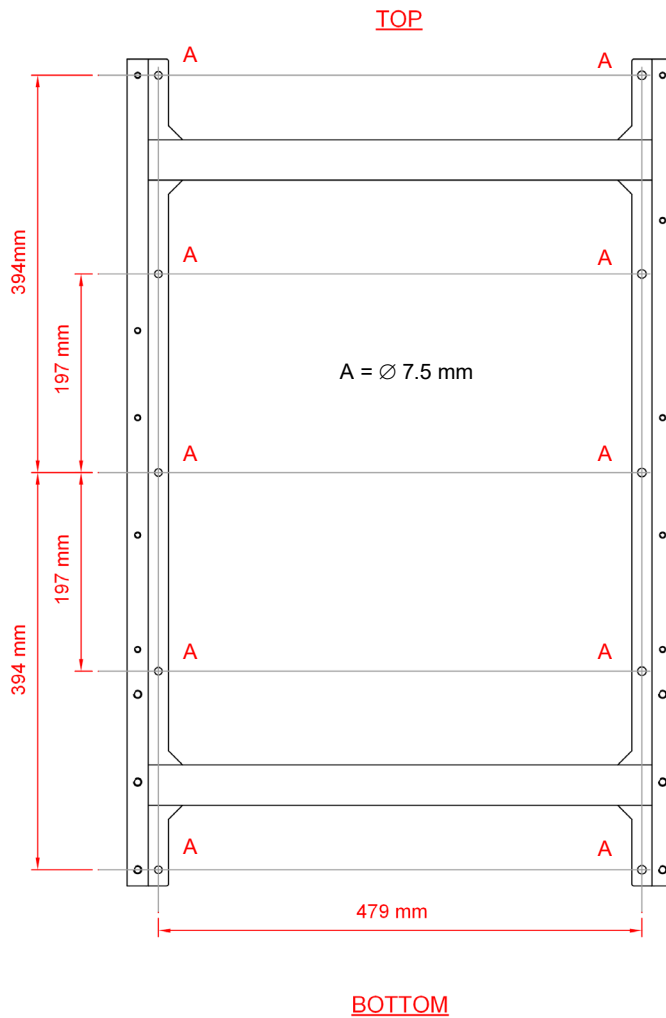

7.7 Installing the Back Box



The INTEGRA is heavy:

- Back box only: 29.25 kg
- Back box + Electronics Module: max. 47.5 kg

It may take two or more people to install the Back Box.

7.7.1 Installing the Back Box with Electronics Module Removed

1. Remove all knock-outs (Ø 20 mm) required for the external wiring (A).

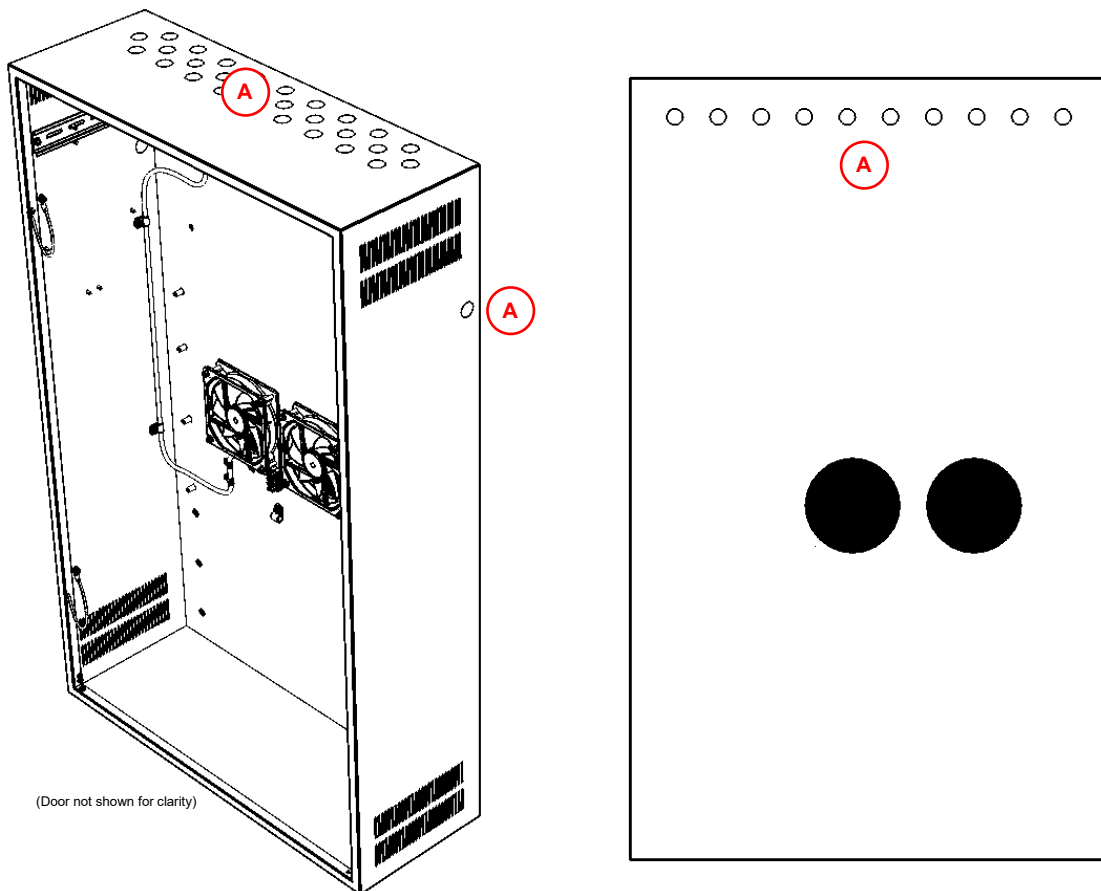

2. Secure the back box to the wall-mount frame using the 6 x M6 nuts and washers (A).



Always ensure that adequate ventilation is provided for the equipment.

Do not block side or front vents and do not obstruct air flow behind enclosure.

3. Secure the Battery Tray to the back box using the 6 x M8 hex head screws and washers (B).



1) Take care to not trap any cabling.

2) Ensure that the 6 x M8 hex head screws are fully tightened so that all the battery weight is held by the wall-mounting frame and fixings, not by the back box. The back box is not designed to support the battery weight.

3) Ensure that all swarf is removed from back box.

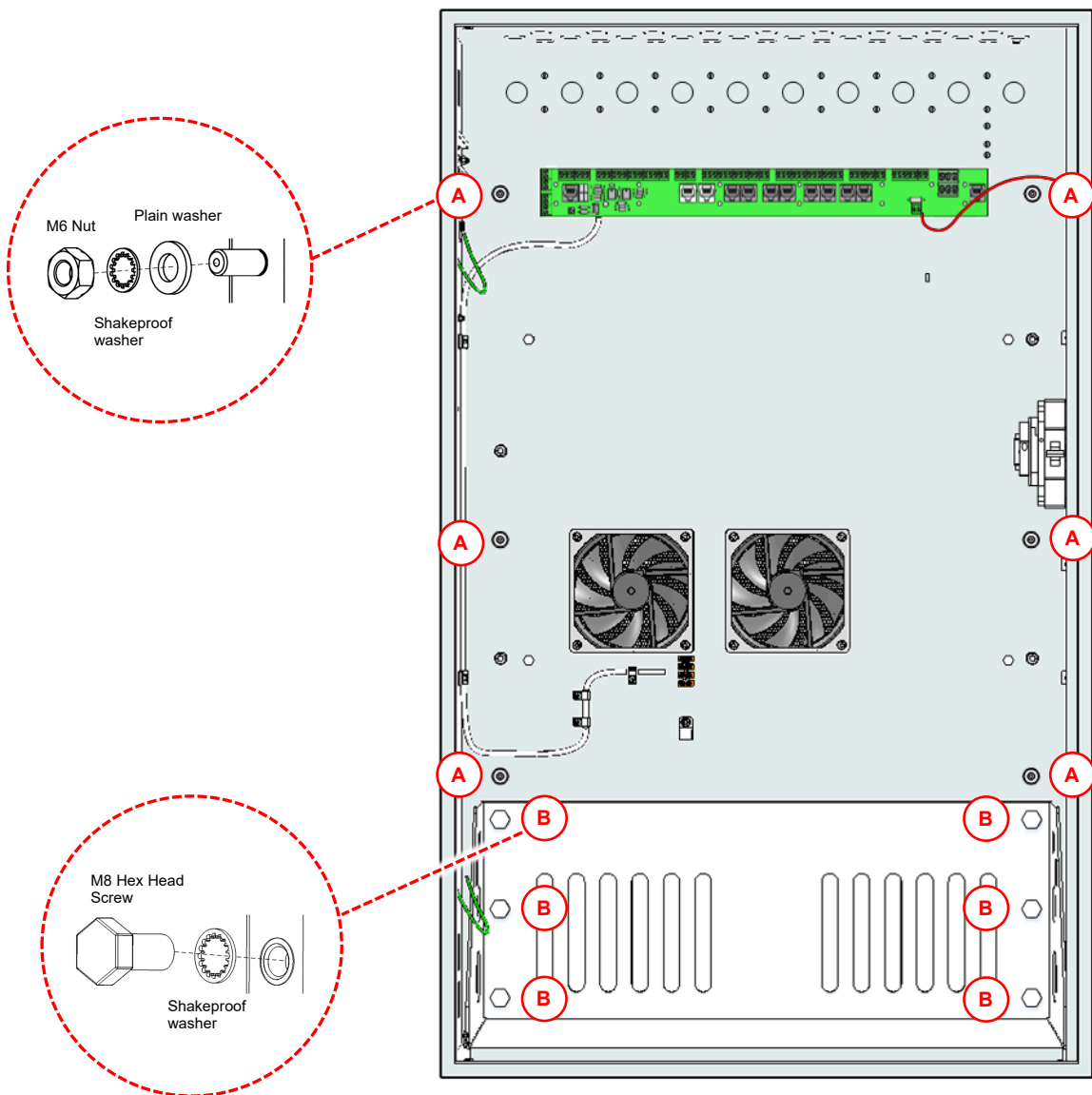

7.7.2 Installing the Back Box with Electronics Module Fitted

1. Remove all knock-outs (Ø 20 mm) required for the external wiring (A).



Care should be taken to prevent swarf falling into the Electronics Module.

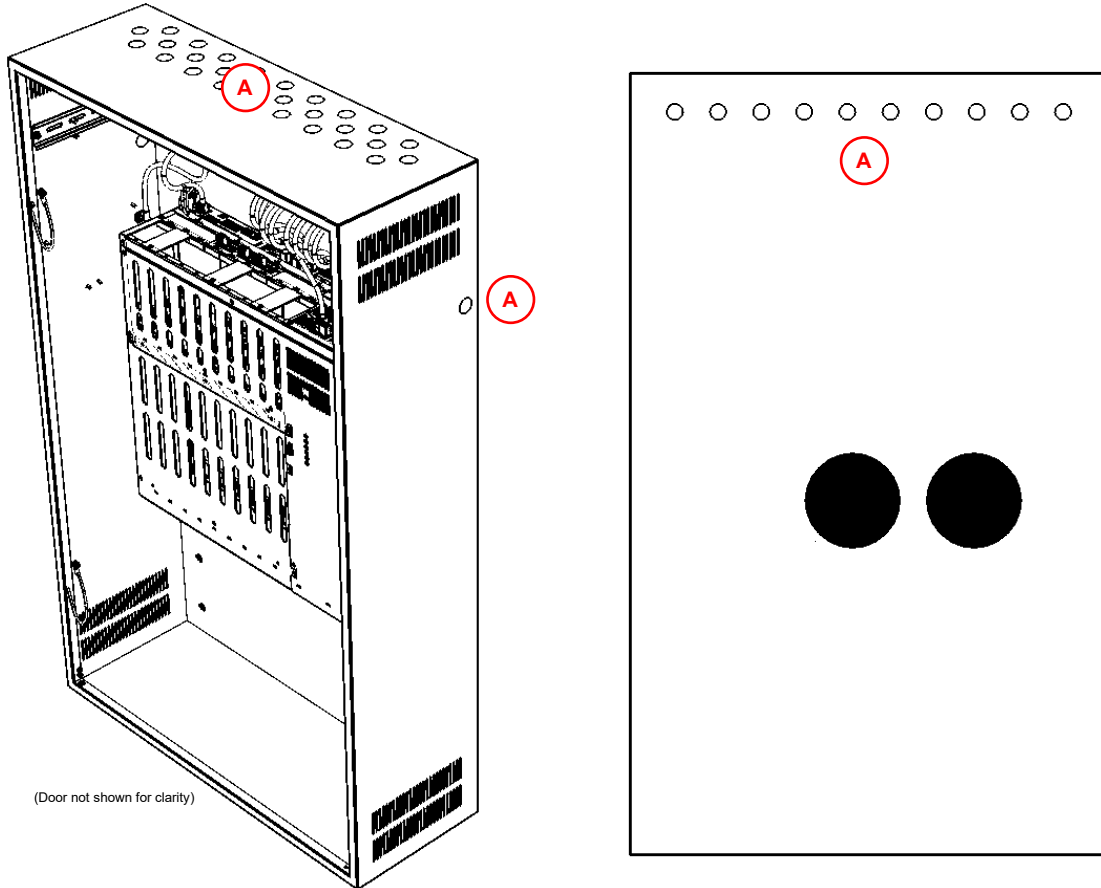

2. Secure the back box to the wall-mount frame using the 6 x M6 nuts and washers (A).



Always ensure that adequate ventilation is provided for the equipment.

Do not block side or front vents and do not obstruct air flow behind enclosure.

3. Secure the Electronics Module to the wall-mount frame using 4 M6 nuts and washers (B).

4. Secure the Battery Tray to the back box using the 6 x M8 hex head screws and washers (C).



1) Take care to not trap any cabling.

2) Ensure that the 6 x M8 hex head screws are fully tightened so that all the battery weight is held by the wall-mounting frame and fixings, not by the back box. The back box is not designed to support the battery weight.

3) Ensure that all swarf is removed from back box.

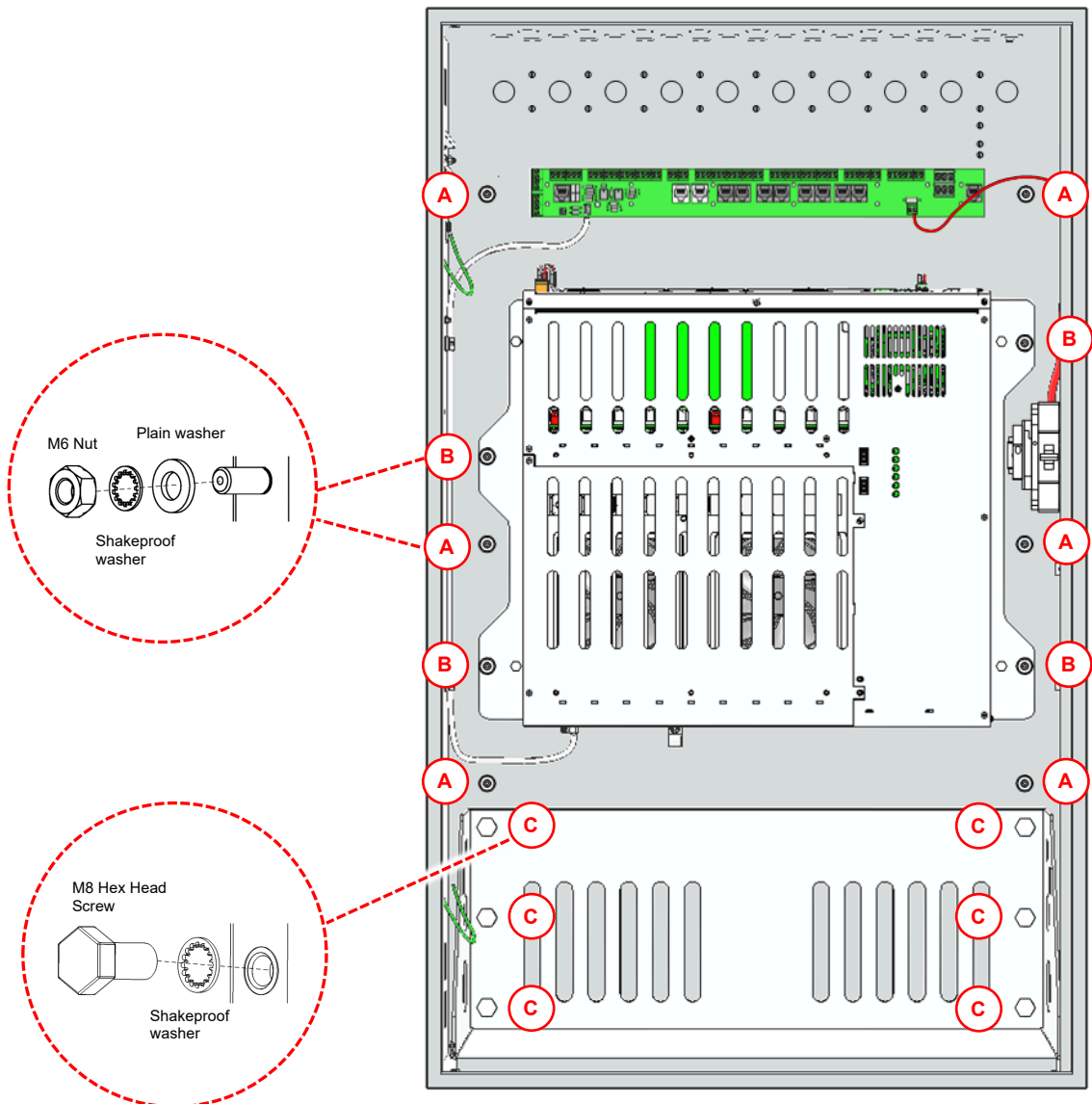

7.8 Fitting a BMB01 Remote I/O to the Pre-Fitted DIN Rail (optional)



The BMB01 should only be fitted to the top left-hand side DIN rail after mounting the back box to the wall as it blocks access to the top left fixing screw.

You will need:

- A BMB01 Remote I/O Unit
- Wiring as described in Section “8.5 BMB01 Connection to INTEGRA” (page 114)
- The BMB01 Installation Guide

1. Refer to the BMB01 Installation Guide (ASL U0450-1693) to:
 - a. Set the Address Switch to the correct address between 1 and 9.
 - b. Fit the Terminator Link (LK3) if the unit is the last (or only) BMB01 on the RS485 bus.
 - c. Set the pull-up links (LK4 and LK5) as required.
2. Attach the BMB01 to the DIN rail on the left-hand side of the back box (**A**) as described on the BMB01 Installation Guide.

(Other components and wiring not shown for clarity)

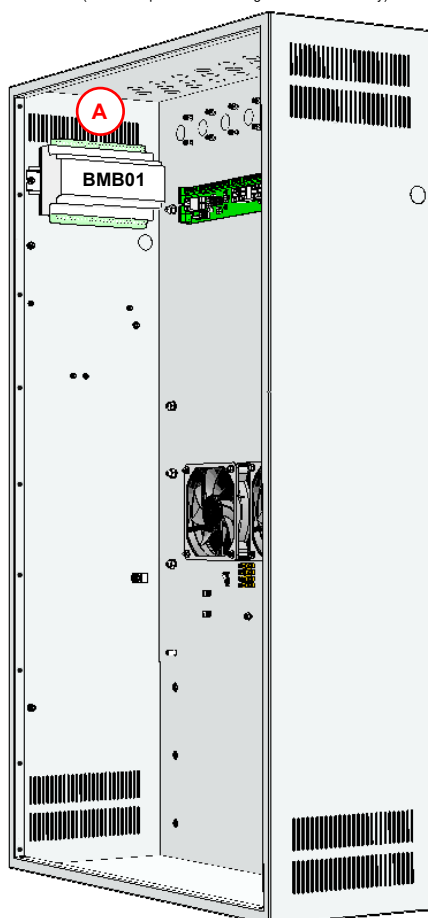

3. Connect the power supply and serial interface wiring from the BMB01 to the Field Termination Board (A).

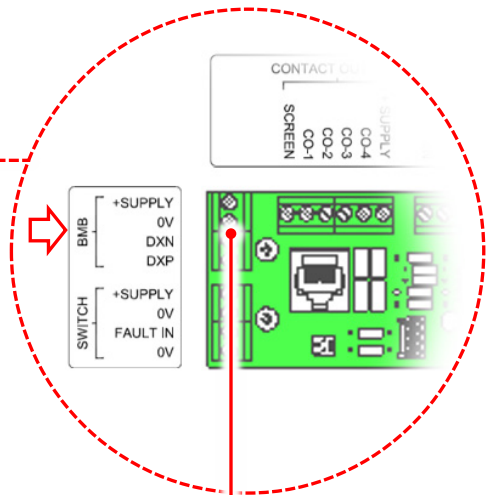
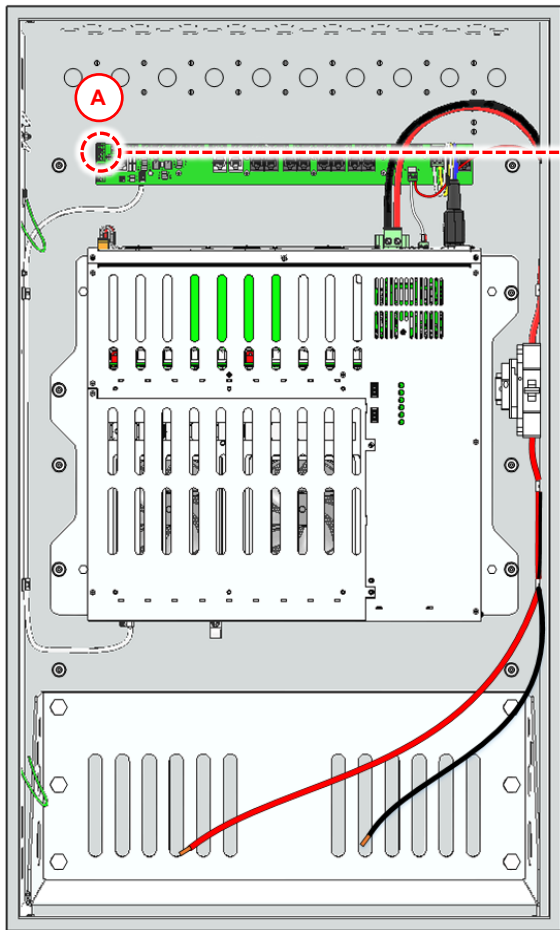

i Ferrules are recommended on all connections.

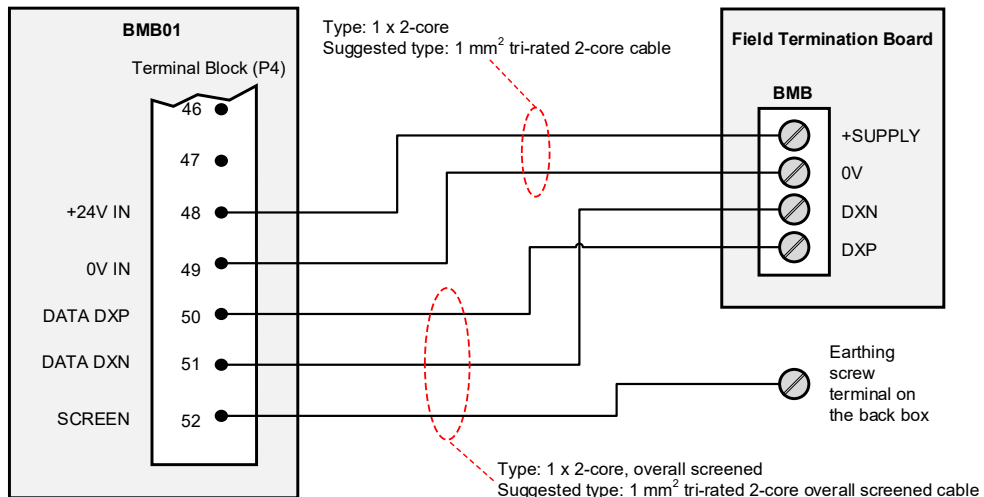

7.9 Re-fitting the Electronics Module (if removed)

1. Take the Electronics Module and carefully fit it into position in the back box, aligning the four mounting holes with the four M6 studs projecting through from the wall-mount frame.
 -  Take care that the mousehole cutout on the bottom of the Electronics Module engages neatly over the fan cable, ensuring that the fan cable is not crushed (A).
2. Secure the Electronics Module to the back box using 4 x M6 nuts and washers (B)
3. Fit 4 x M5 hex head transit screws and washers (C).

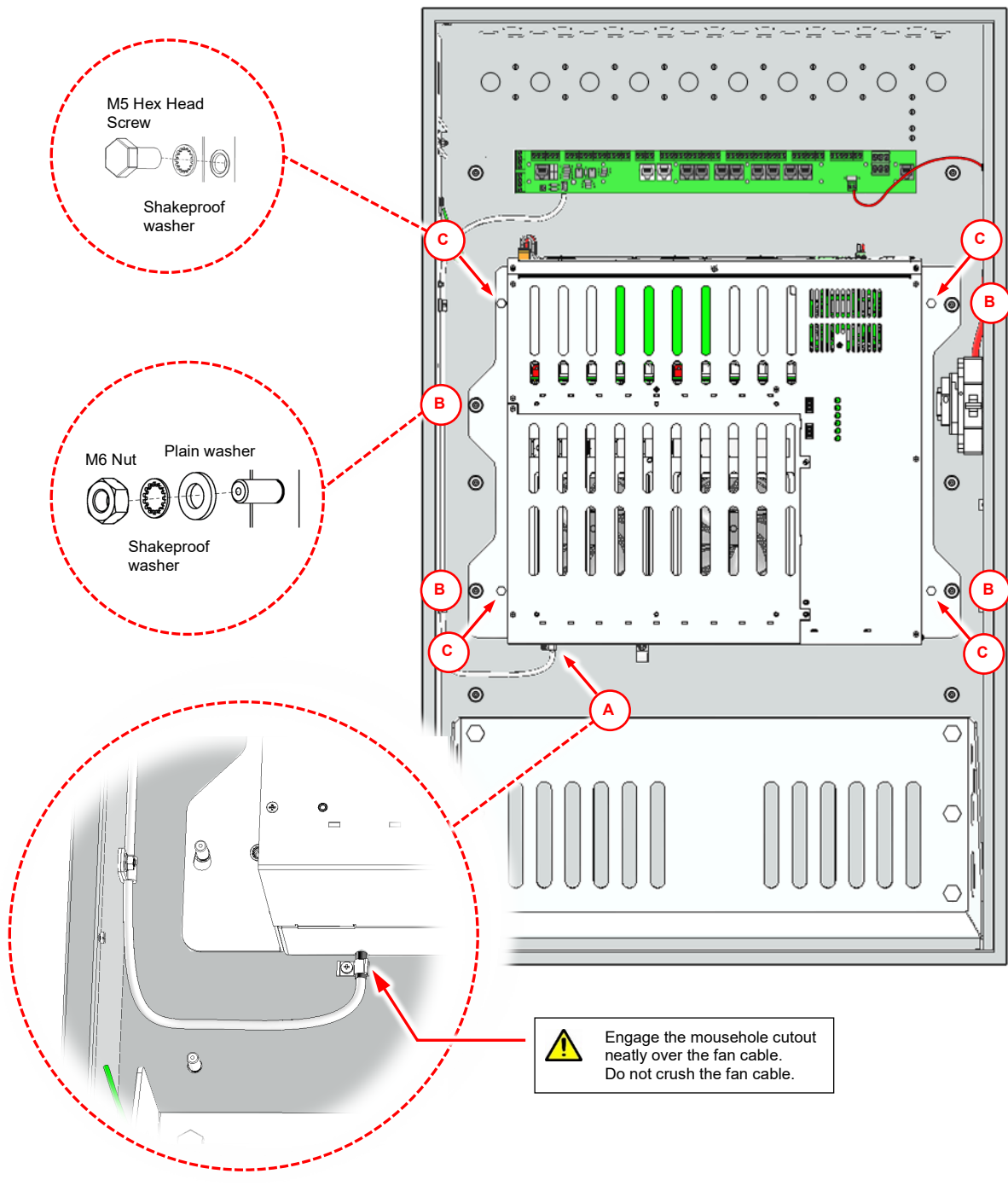

4. Reconnect the ribbon cables from the front panel to the headers on the left-hand side of the Electronics Module (A).

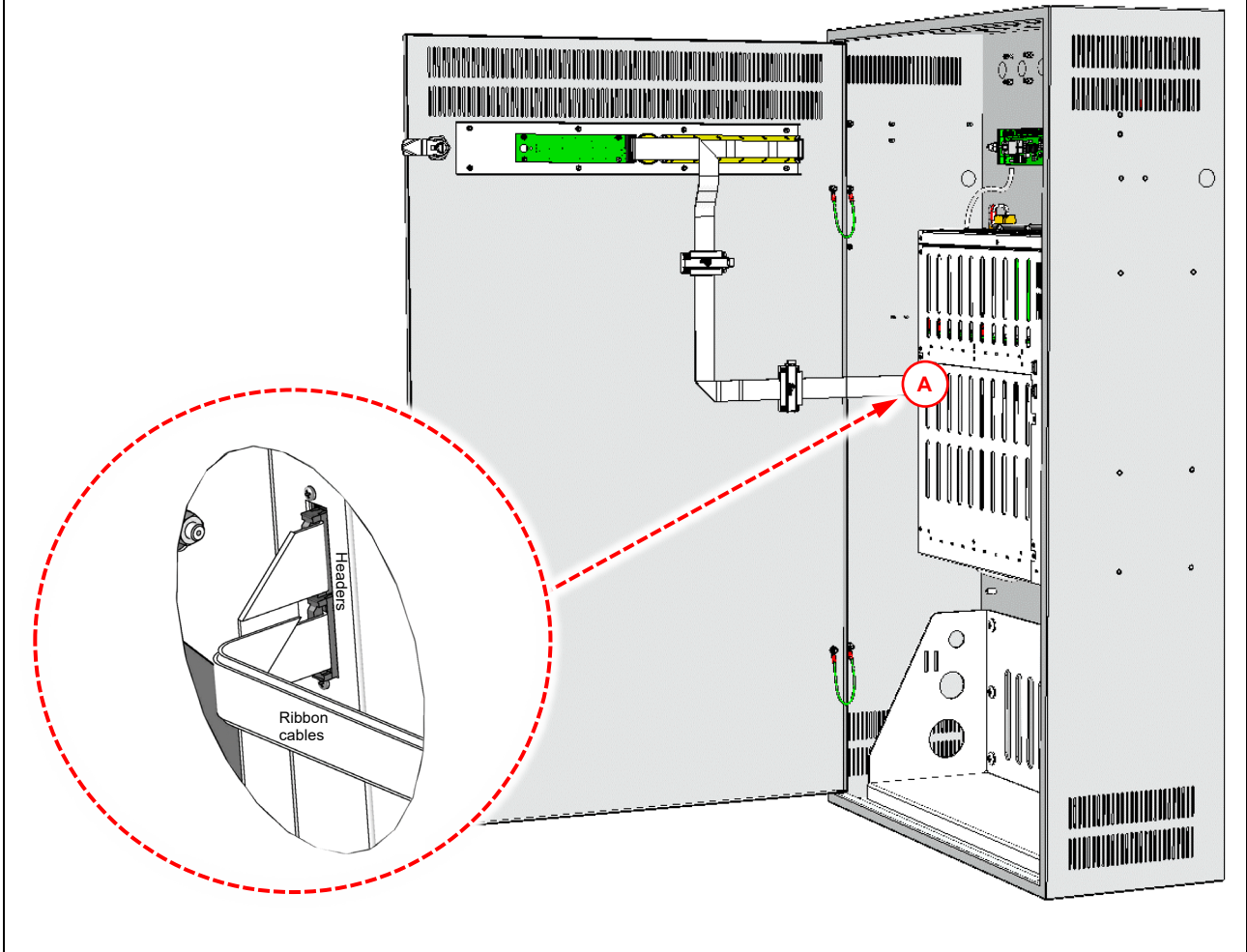

5. Reconnect the white power supply wiring to the Termination Board (A).
6. Reconnect the thermistor cable to connector NTC PROBE of the Electronics Module (B).

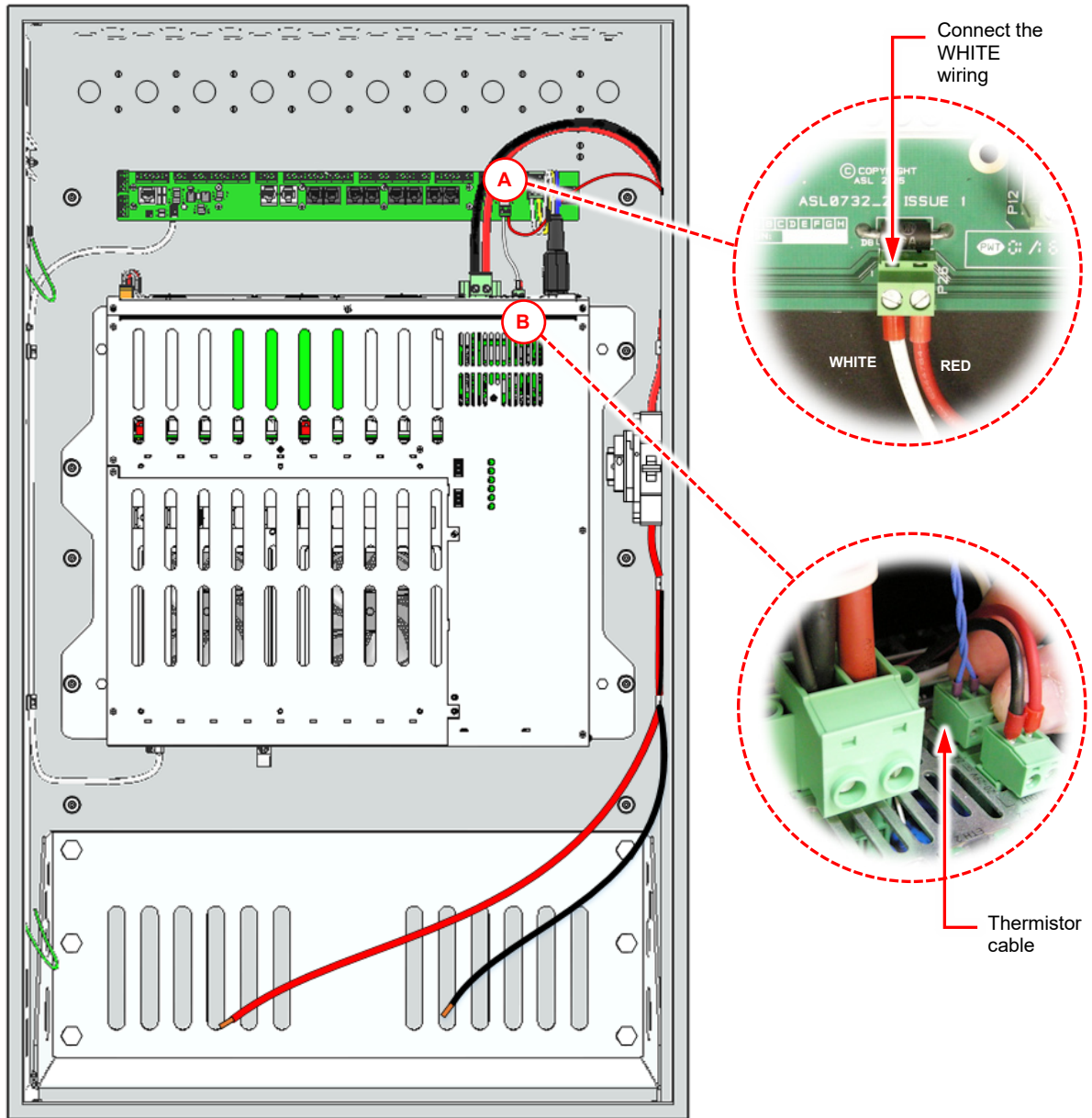

7. Reconnect the mains cable to the Electronics Module (A).
8. Reconnect the red RJ45 patch lead to the Electronics Module's CTRL 1 port (B).
9. Reconnect the battery cable to the Electronics Module and fasten the two strain-relief screws (C) using a small flat-blade screwdriver.



Ensure that no conductor strands are visible at the plug and circuit breaker terminals.

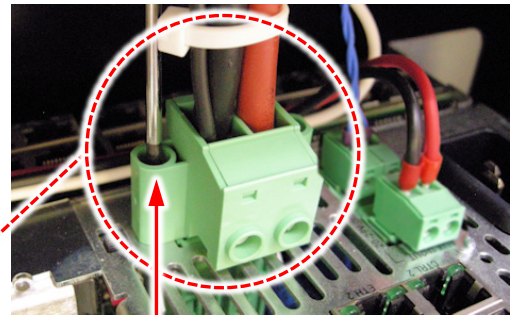
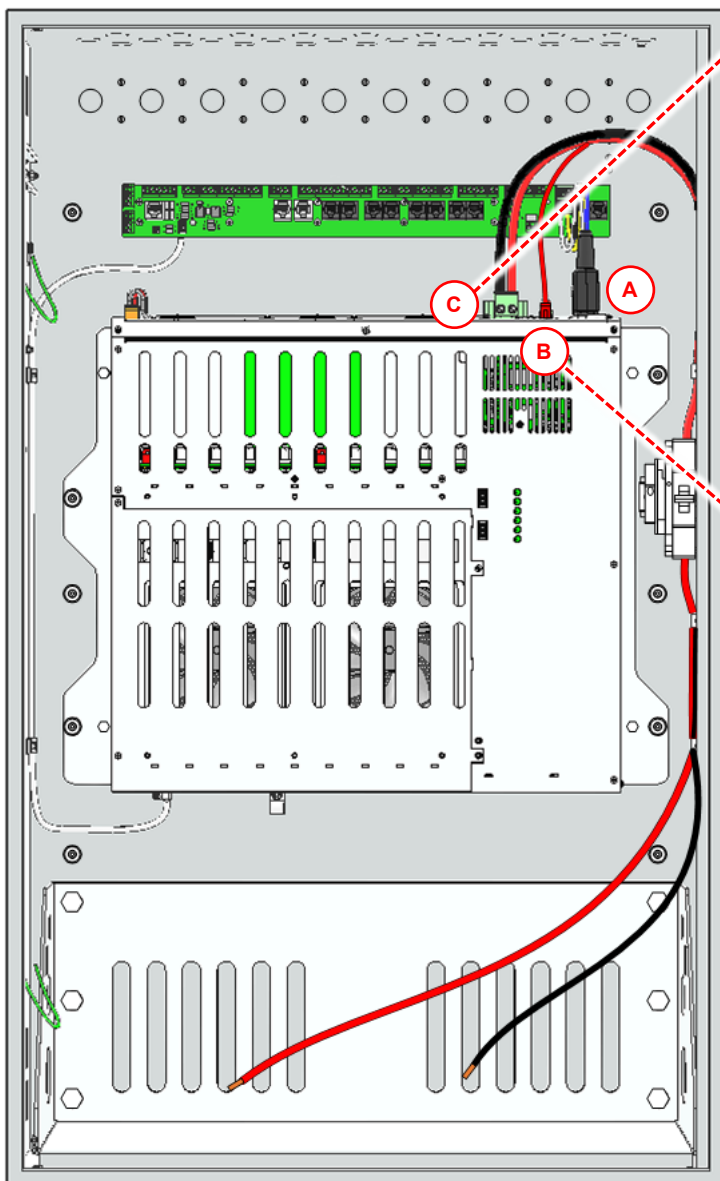

 Fasten the captive strain-relief screws on both side of the connector.

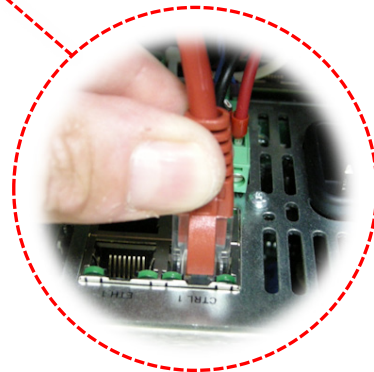

7.10 Connecting the RJ45 Patch Leads to the Electronics Module (if removed)

1. Connect one end of the grey RJ45 patch leads (supplied) to the Router and the other end to the Termination board as shown below.

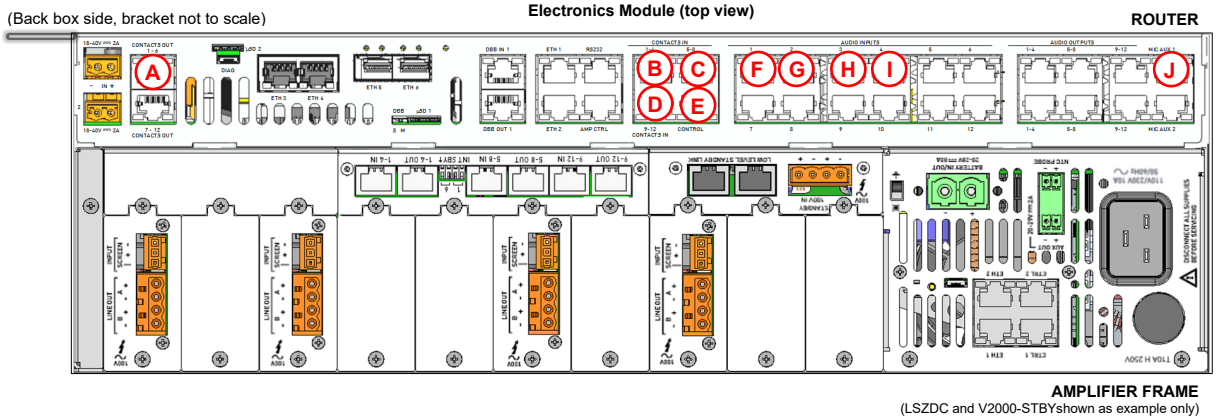
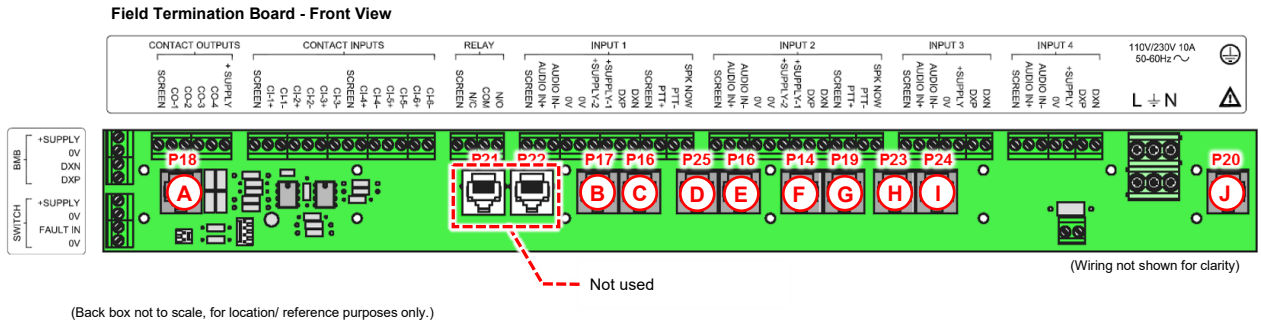

	Router Connector	Field Termination Board Connector	RJ45 Patch Lead Colour (Size)
Ⓐ	CONTACTS OUT 1-6	P18	Grey (200 mm)
Ⓑ	CONTACTS IN 1-4	P17	Grey (200 mm)
Ⓒ	CONTACTS IN 5-8	P16	Grey (200 mm)
Ⓓ	CONTACTS IN 9-12	P25	Grey (200 mm)
Ⓔ	CONTROL	P15	Grey (200 mm)
Ⓕ	AUDIO INPUT 1	P14	Grey (200 mm)
Ⓖ	AUDIO INPUT 2	P19	Grey (200 mm)
Ⓗ	AUDIO INPUT 3	P23	Grey (200 mm)
Ⓘ	AUDIO INPUT 4	P24	Grey (200 mm)
Ⓙ	MIC AUX1	P20	Grey (200 mm)

2. Connect one end of the blue RJ45 patch leads (supplied) to the Router and the other end to the Amplifier Frame as shown below.

(Back box side, bracket not to scale)

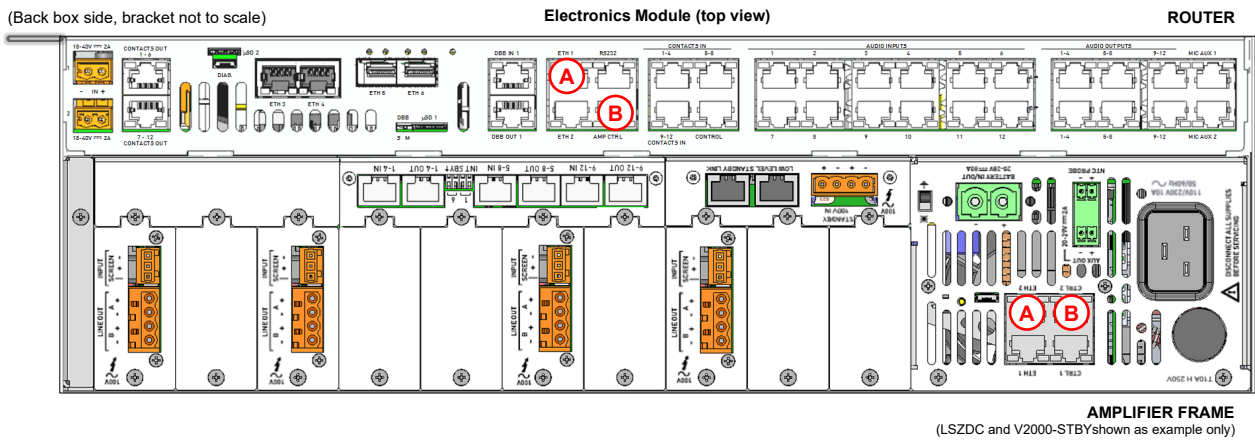

	Router Connector	Amplifier Frame Connector	RJ45 Patch Lead Colour (length)
Ⓐ	ETH1	ETH2	Blue (300 mm)
Ⓑ	AMP CTRL	CTRL2	Blue (300 mm)

3. Connect one end of the yellow RJ45 patch leads (supplied) to the Router and the other end to the Amplifier Frame as shown below.

(Back box side, bracket not to scale)

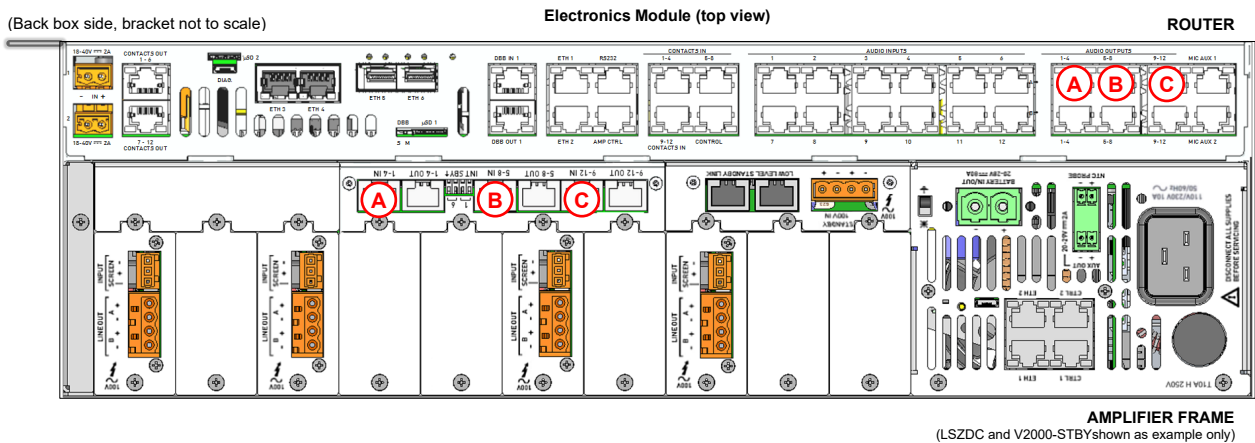

	Router Connector	Amplifier Frame Connector	RJ45 Patch Lead Colour (length)
Ⓐ	AUDIO OUTPUTS 1-4	1-4 IN	Yellow (500 mm)
Ⓑ	AUDIO OUTPUTS 5-8	5-8 IN	Yellow (500 mm)
Ⓒ	AUDIO OUTPUTS 9-12	9-12 IN	Yellow (500 mm)

4. Tether the three yellow and two blue patch leads neatly together as shown below using a 2.5 mm LSZH cable tie (A).

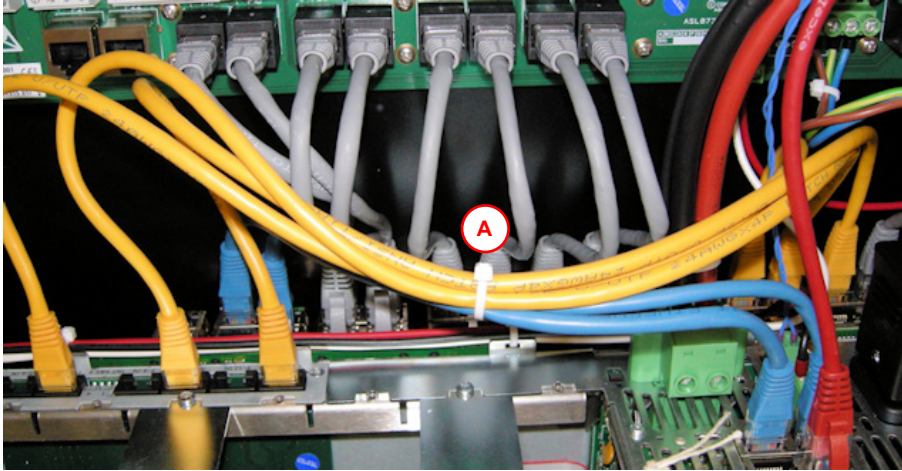

i Trim excess cable tie neatly.

7.11 Connecting the Hirschmann Network Switch to the Electronics Module (if fitted)

Connect one end of a CAT5 patch lead to the RJ45 Ethernet port number 3 of the Network Switch and the other end to the ETH2 port of the Router (A).

Note:

INTEGRA-PRO units may be supplied with a CAT5 patch lead for connection to the Network Switch.

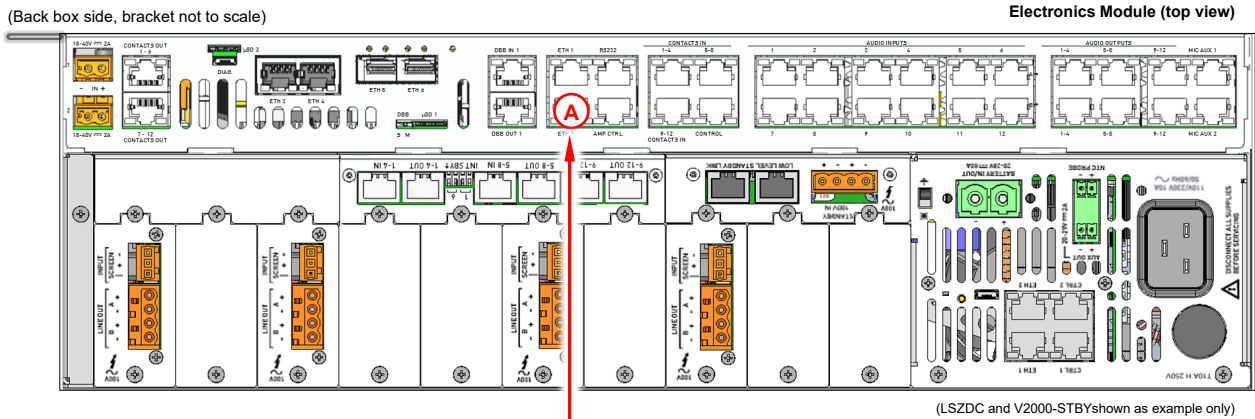

Hirschmann RS20-04 Network Switch (top view)

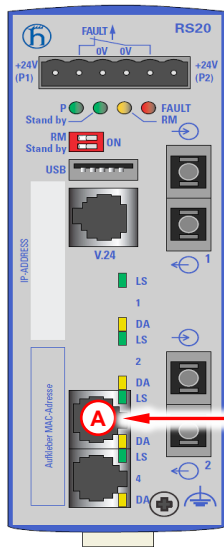

7.12 Fitting a BOA01/BOA02 Break Out Adaptor to the Pre-Fitted DIN Rail (optional)

You will need:

- BOA01/BOA02 adaptor(s)
- Patch leads (300-500 mm) (as required)

1. Attach the BOA to the DIN rail on the top left-hand side of the back box (A).

(Other components and wiring not shown for clarity)

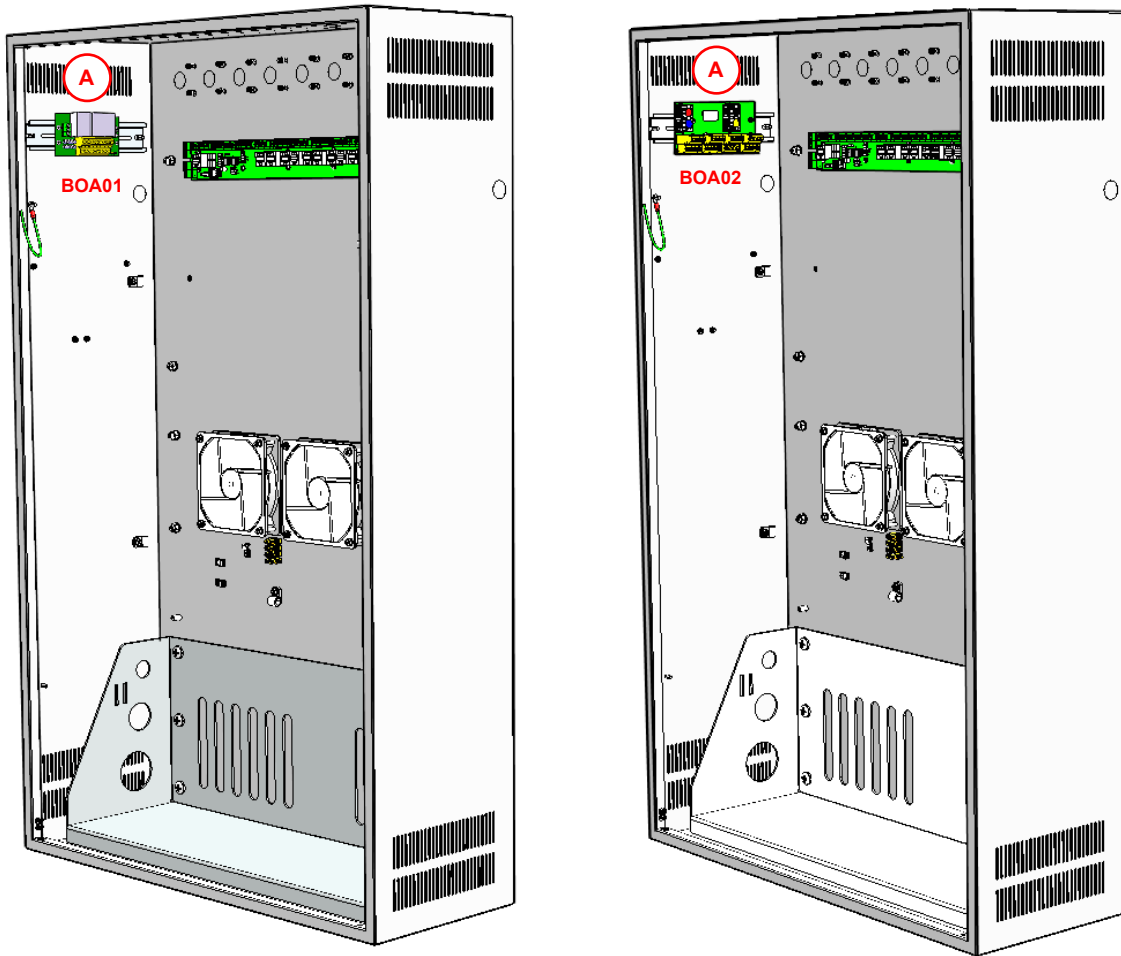

2. Connect the RJ45 patch lead(s) to the BOA and the required ports on the Electronics Module.
Refer to Section “8.2 Router Connections” (page 89) for details of the Router connections.
3. Tether the patch leads neatly together using a 2.5 mm LSZH cable tie, and trim excess cable tie neatly.

7.13 Connecting the External Mains Power Supply



Ensure that the mains supply is through a dedicated cable entry.



Always ensure that the equipment is correctly earthed by connection to an AC mains supply with a protective earth connection.



The INTEGRA is designed for permanent connection to a mains supply. A readily accessible all-pole mains isolator with a separation of 3 mm in each pole shall be incorporated in the electrical installation.



The INTEGRA is protected from overload by single pole phase fusing. If connected to an unpolarised mains supply, the building installation must provide double pole phase/neutral fusing of appropriate rating.



Caution! Electrical shock hazard. Disconnect all power supplies.





Always isolate the mains and battery supplies by switching off the INTEGRA mains supply at the external isolator and at the internal battery supply circuit breaker before installation, servicing or maintenance. In installations where the external mains supply isolation switch is not accessible, unplug the mains power supply cable from the Electronics Module.



The INTEGRA may still be energised after isolating the mains and battery supplies.

After the internal “processor” LED has stopped flashing, leave the INTEGRA for another 5 minutes before attempting internal servicing.

1. Ensure that the power supply to the unit is disconnected by:
 - a. Switching off the external mains supply isolator.
 - b. Switching off the battery circuit breaker on the left-hand side of the back box (down position) **(A)**.
 - c. Switching off the MAINS and BATTERY switches on the Electronics Module **(B)**.
2. Feed the mains power supply wiring into the unit through cable glands or conduit and connect it to the Field Termination Board and back box:
 -  Care should be taken to prevent swarf falling into the Electronics Module.
 - a. Connect the LIVE wiring to the **L** terminal on the Field Termination Board **(C)**.
 - b. Connect the NEUTRAL wiring to the **N** terminal on the Field Termination Board **(D)**.
 - c. Connect the EARTH wiring to the protective earth terminal on the back box **(E)**.
 -  Do not disconnect the factory fit earth strap **(F)**.
 - d. Tie wrap the LIVE, NEUTRAL and earth strap using a LSZH cable tie **(G)**, and trim excess cable tie neatly.
 - e. Secure the mains cable to the back box using a suitable P-clip (supplied in different sizes), washers and M4 plain nut **(H)**.

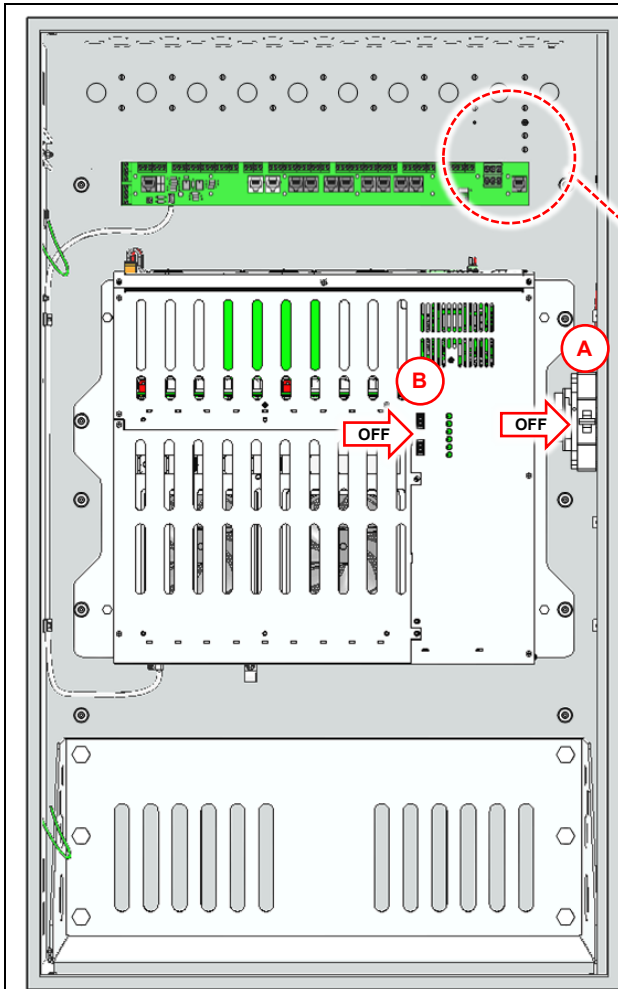

(Internal wiring not shown for clarity)

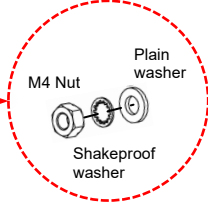
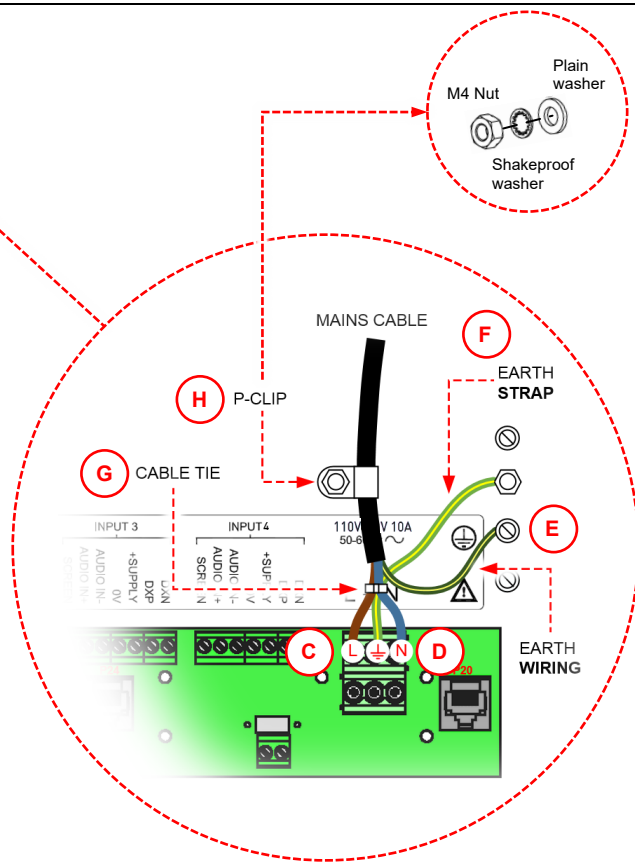

i Trim excess cable tie neatly.

Wiring	Colour (IEC 60445)	Screw Terminal	Description
Mains cable	Brown	L	Live
	Green/Yellow	⊕ (on the back box)	Protective Earth
	Blue	N	Neutral
Earth strap (factory fit)	Green/Yellow	⊕ (on the terminal board)	Earth

6. Label the external mains supply isolator using the **MAINS DISCONNECT DEVICES** label (provided).

Mains supply isolator and label (example)

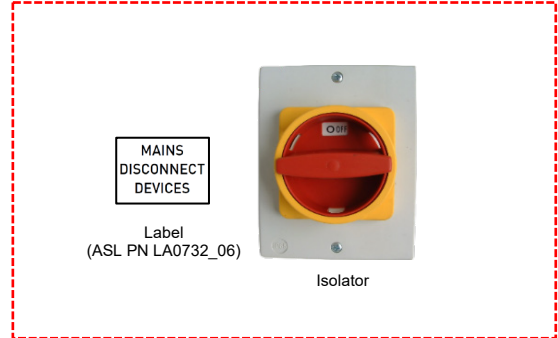

7.14 Connecting the Field Wiring/Cabling

1. Feed all field wiring into the unit through cable glands or conduit.

Cables may be glanded, dressed, and cut to approximately the correct length.

Refer to Section “8 Connections” (page 85) for pinout details.



The cable glands or conduits must provide at least IP3X ingress protection to guard against metal or burning objects entering the enclosure and causing a hazard and to permit compliance to EN 54-16.



Care should be taken to prevent swarf falling into the Electronics Module.

2. Connect the field wiring to the screw terminals on the Field Termination Board at the rear of the back box (top) (A) as required.

Ferrules are recommended on all connections.



For EMC compliance:

- a. Terminate the incoming drain wires to the SCREEN terminal on the Field Termination Board or one of the earth screw terminals available on back box (B).
- b. All screen tails to be < 3 cm.

3. Connect the speaker lines to the Amplifier Frame’s LINE OUT connectors (C) as required.



The INTEGRA contains wiring that can be energised to 100 V RMS audio signals at up to 20 kHz.

Terminals marked with the ⚡ symbol are hazardous, and the external wiring connected to these terminals requires installation by instructed personnel.



Before connecting the speaker lines to the INTEGRA it is advisable to check the speaker lines to confirm that:

- a. For DC line monitoring, the expected number of End of Line Resistors (ASL EOL10K) is fitted, and the A and B circuits are evenly loaded.
- b. For Impedance monitoring, the expected number of End of Line Impedance Device (ASL EOLZ01) is fitted, and the A and B circuits evenly loaded.
- c. For IEL line monitoring, the expect number of Intelligent End of Line Devices (ASL IEL01) is fitted and set with correct address.
- d. The impedance is as expected and does not exceed the capability of the associated amplifier configuration.
- e. All speaker lines are isolated from earth.

4. Connect the standby amplifier wiring (D) as required.

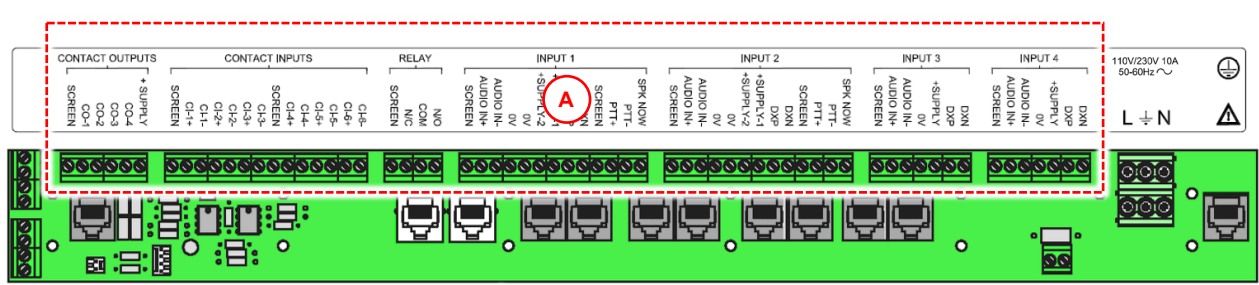

(Internal wiring not shown for clarity.)

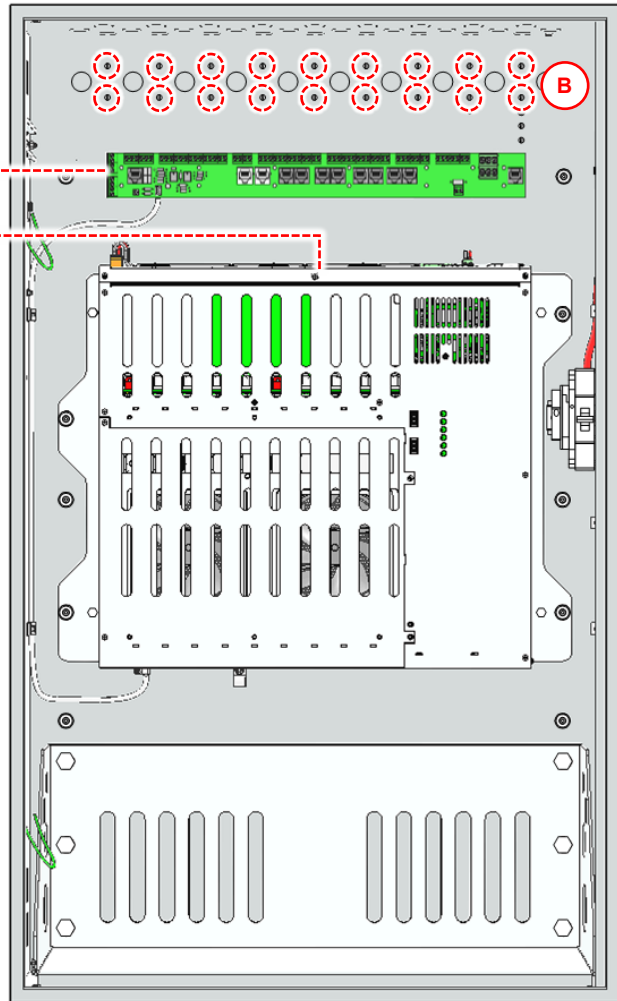

Electronics Module (top view)

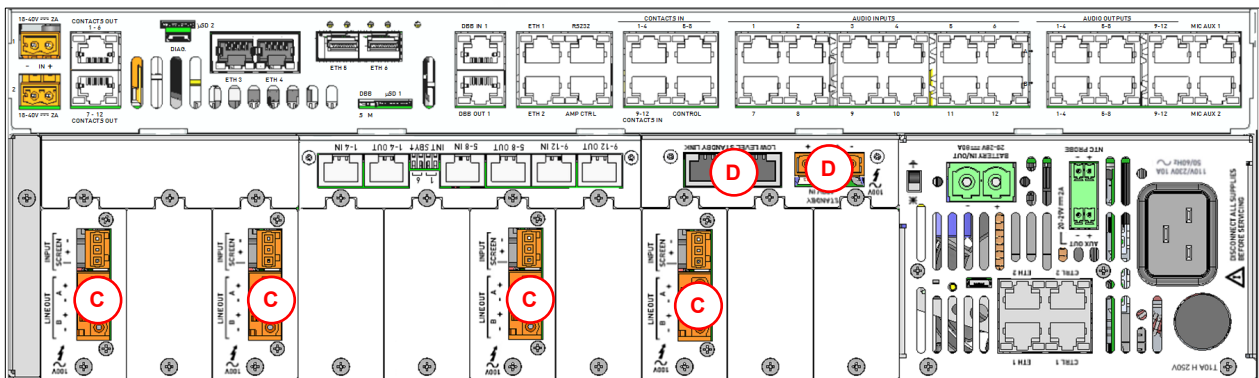

(LSZDC and V2000-STBY shown as example only)

5. If a BMB01 unit is fitted, connect the field wiring to the BMB01 screw terminals.

DIGITAL INPUTS

ANALOGUE INPUTS DIGITAL OUTPUTS

i Ferrules are recommended on all connections.

6. If a BOA01 or BOA02 is fitted, connect the field wiring to the screw terminals on the BOA as required (**A**).

Refer to Section “8.2.2 Break-Out Adaptor (BOA) Connections” (page 98) for connection and pinout details.

! For EMC compliance:

- Terminate the incoming drain wires to the SCREEN terminal on the Break Out Adaptor.
- All screen tails to be < 3 cm.

BOA02

BOA01

i Ferrules are recommended on all connections.

7. If a Hirschmann Network Switch is fitted, connect the fibre cabling to the fibre optic ports (**A**) of the Network Switch.

Hirschmann RS20-04 Network Switch (top view)

7.15 Fitting an Expansion DIN Rail (optional)



The Expansion DIN Rail should be fitted after connecting the field wiring to the termination board and amplifiers.

You will need:

An Expansion DIN Rail (ASL INTEGRA-DIN-KIT)

1. The support brackets for the Expansion DIN Rail should be fitted before the back box installation as described in Section “7.3 Fitting Expansion DIN Rail Support Brackets (optional)” (page 47).
2. Secure the DIN rail to the support brackets using 2 x M4 nuts and washers (A).

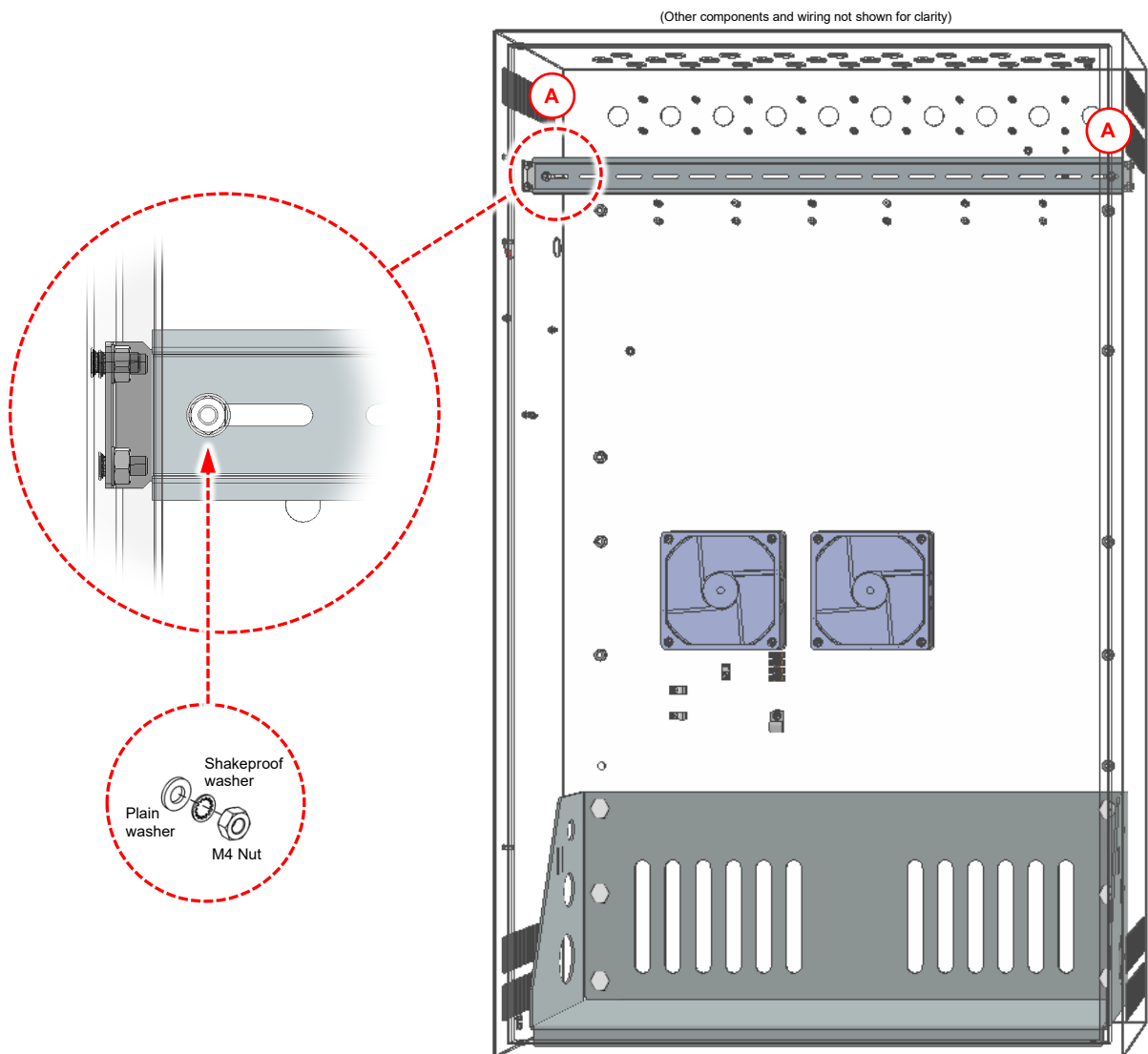

7.15.1 Fitting a BMB01 Remote I/O Unit to the Expansion DIN Rail (optional)

You will need:

- A BMB01 Remote I/O Unit
- Wiring as described in Section “8.5 BMB01 Connection to INTEGRA” (page 114)
- The BMB01 Installation Guide

1. Connect the power supply and serial interface wiring to the Field Termination Board (A).

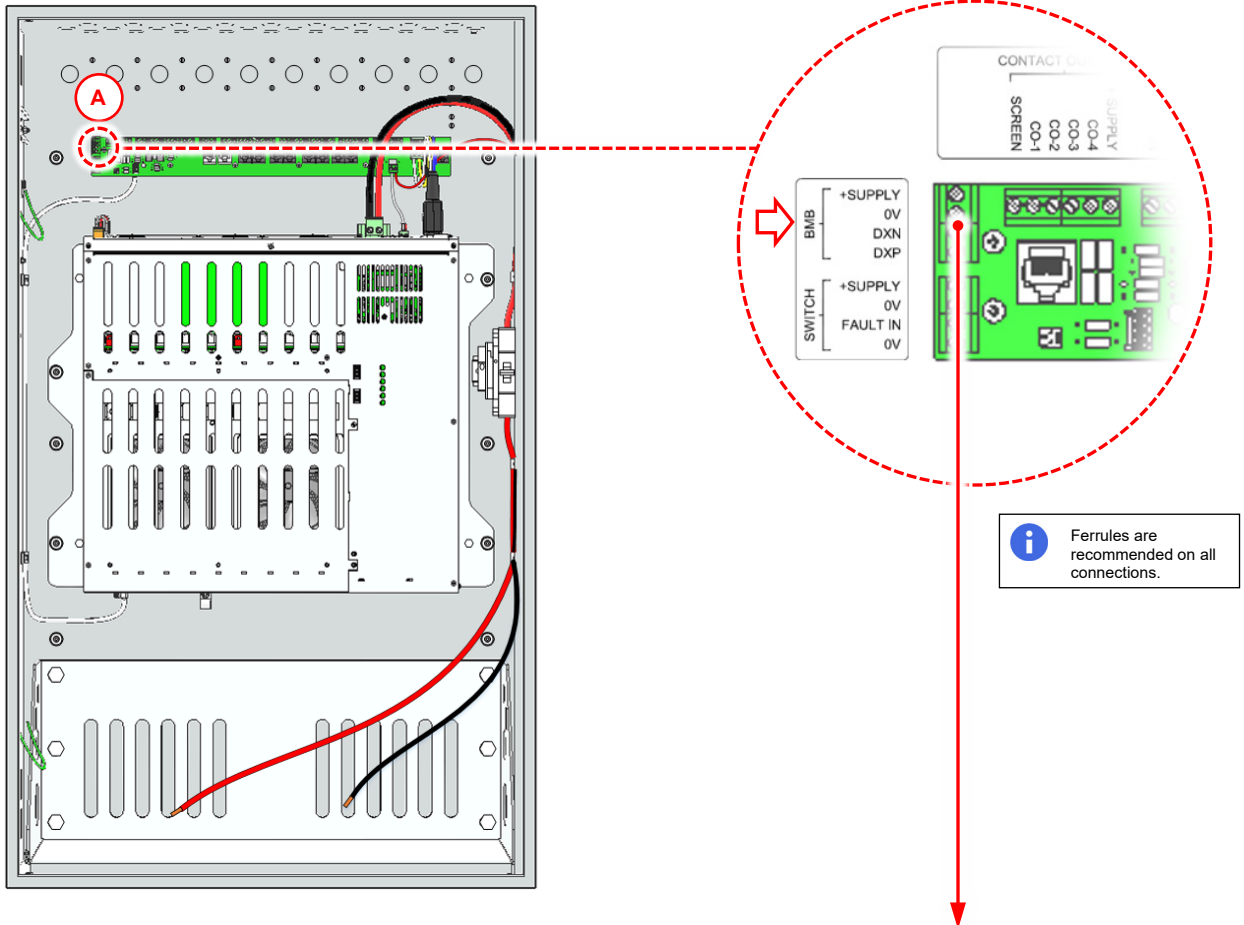

i Ferrules are recommended on all connections.

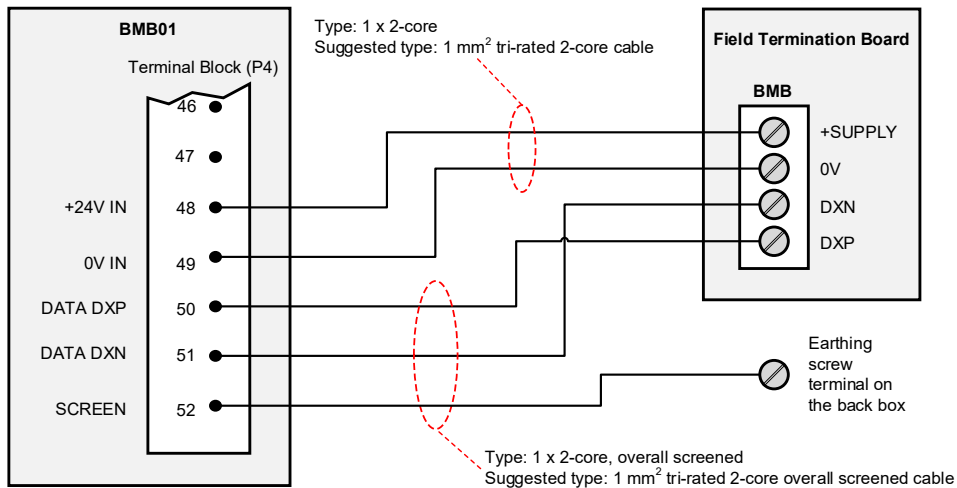

Connect this end after installing the BMB01.

2. Refer to the BMB01 Installation Guide (ASL U0450-1693) to:
 - a. Set the Address Switch to the correct address between 1 and 9.
 - b. Fit the Terminator Link (LK3) if the unit is the last (or only) BMB01 on the RS485 bus.
 - c. Set the pull-up links (LK4, LK5) as required.

3. Attach the BMB01 to the Expansion DIN Rail (**A**) as described on the BMB01 Installation Guide.

(Other components and wiring not shown for clarity)

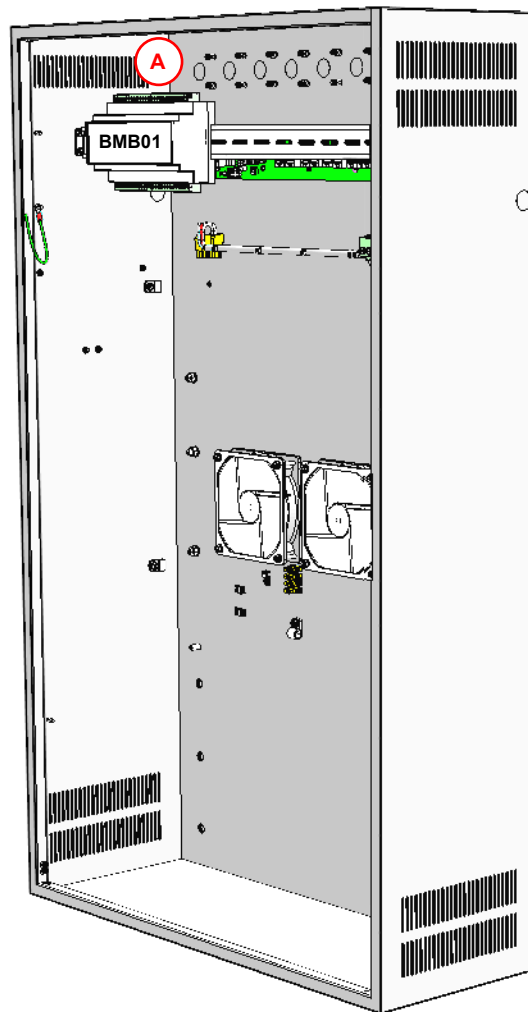

4. Connect the power supply and serial interface wiring to the BMB01; see connection diagram in step 1 above.

7.15.2 Fitting a BOA01/BOA02 Break Out Adaptor to the Expansion DIN Rail (optional)

You will need:

- BOA01/BOA02 adaptor(s)
- Patch leads (300-500 mm) (as required)

1. Attach the BOA to the Expansion DIN Rail (A).

(Other components and wiring not shown for clarity)

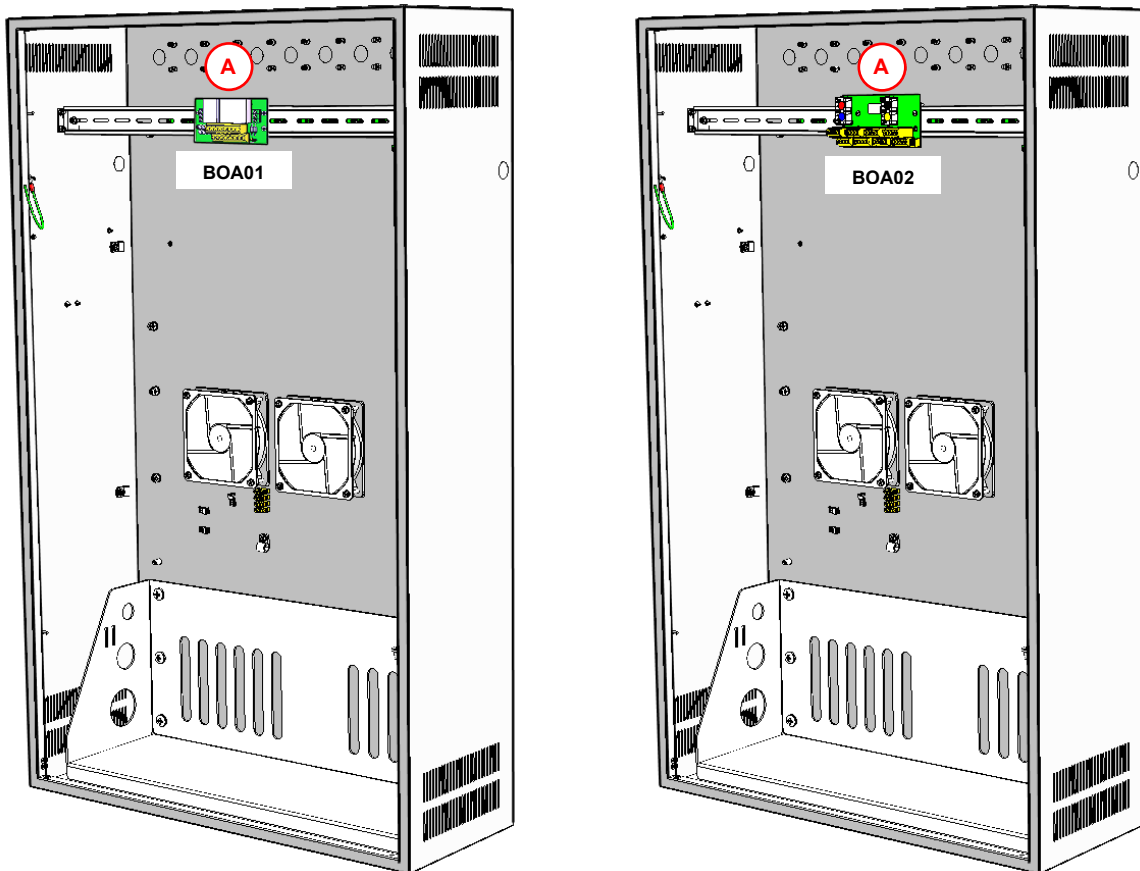

2. Connect the RJ45 patch lead(s) to the BOA and the required ports on the Electronics Module.
Refer to Section “8.2 Router Connections” (page 89) for details of the Router connections.
3. Tether the patch leads neatly together using a 2.5 mm LSZH cable tie, and trim excess cable tie neatly.

7.16 Installing and Connecting the Batteries



- 1) Use only battery type Power Sonic PS-12750 FR, PG-12V75T FR, PG-12V65 FR or PG-12V80 FR can be used in an INTEGRA unit.
- 2) Do not mix battery types with different Ah ratings in an INTEGRA unit.
- 3) To ensure IEC / EN 62368-1 compliance, INTEGRA batteries must be rated to UL 94-V0 flammability. Note that any Power Sonic batteries without FR (V0) product codes are only rated to UL 94-HB flammability.
- 4) The conditions for storage and maintenance of the batteries prior to system installation and commissioning affects their service life; please refer to ASL “Recommended Battery Care and Maintenance Procedures” (U0456-0212) for further details.

Ensure that the batteries used in the installation have been properly stored.

1. Ensure that all swarf is removed from the back box.
2. Ensure that the power supply to the unit is disconnected by:
 - a. Switching off the external mains supply isolator.
 - b. Switching off the circuit breaker on the left-hand side of the back box (down position) **(A)**.
 - c. Switching off the MAINS and BATTERY switches on the Electronics Module **(B)**.
3. Ensure that the thermistor probe is fitted to the cable clip at the back of the battery tray and is positioned as shown below **(C)**.
4. Ensure that the excess of thermistor cable is tucked between the right-hand edge of the battery tray and the inner face of the back box as shown below **(D)**.

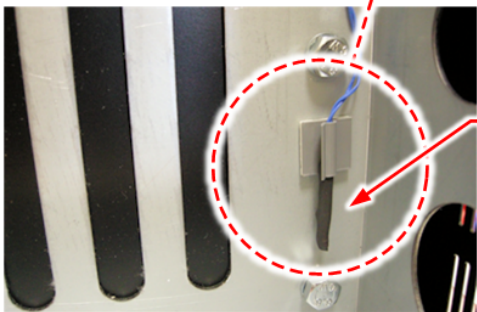
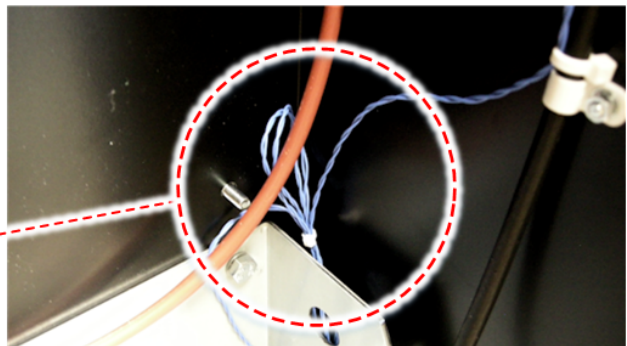
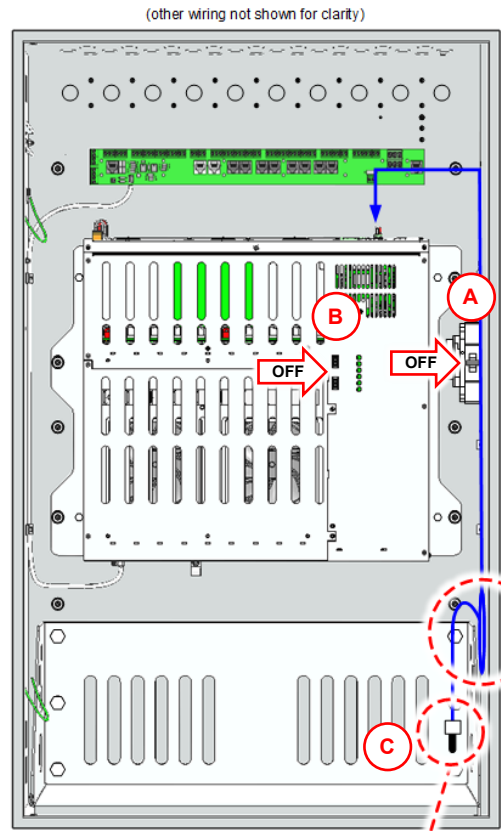

THERMISTOR PROBE
 Note that the widest part of the thermistor probe will not fit in the clip and must lie below it.

5. Carefully lift the batteries into position and secure with the strap provided (A).



Batteries are heavy (max. 25 kg each).

Move and handle with care to avoid personal injuries or damage to the batteries.

6. Connect the battery cables noting correct polarity and orientation of the ring lugs (see below):



Always use insulated tools.

- a. Positive (B): connect the red battery terminal cable from the back box to the positive terminal of the left-hand side battery.
- b. Interlink (C): connect the black-band end of the interlink cable to the negative terminal of the left-hand side battery, and then connect the red-band end to the positive terminal of the right-hand side battery.
- c. Negative (D): connect the black battery terminal cable from the back box to the negative terminal of the right-hand side battery.

7. Cover battery terminals with insulating caps.

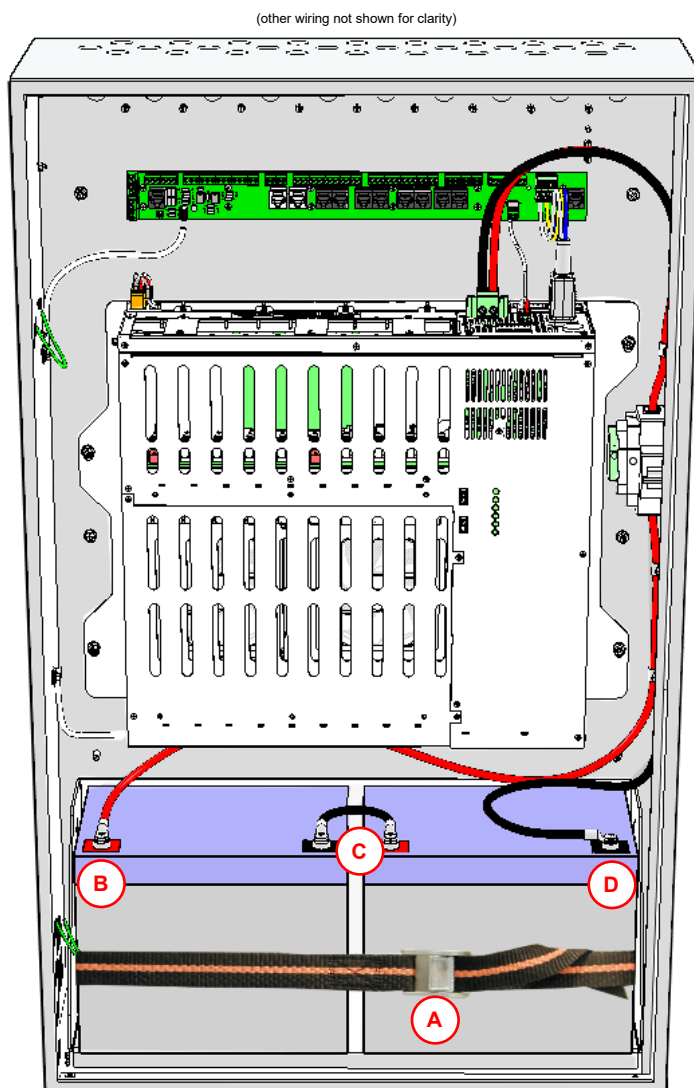

- 1) Note correct polarity:
Red=Positive
Black=Negative
- 2) Position the terminal lugs as shown on the diagram.
- 3) Cover battery terminals with insulating caps.

7.17 Powering On the INTEGRA



Caution! Electrical shock hazard. Disconnect all power supplies.



Always isolate the mains and battery supplies by switching off the INTEGRA mains supply at the external isolator and at the internal battery supply circuit breaker before installation, servicing or maintenance. In installations where the external mains supply isolation switch is not accessible, unplug the mains power supply cable from the Electronics Module.





The INTEGRA may still be energised after isolating the mains and battery supplies.

After the internal “processor” LED has stopped flashing, leave the INTEGRA for another 5 minutes before attempting internal servicing.



When reconnecting the battery always ensure that the BATTERY supply switch is off before the battery isolation switch is turned on.

1.	Ensure that the external mains supply isolator, the battery circuit breaker and the MAINS and BATTERY switches on the Electronics Module are off.
2.	<p>Power on the INTEGRA as follows.</p> <ul style="list-style-type: none"> a. Switch on the external mains supply isolator. b. Switch on the MAINS switch on the Electronics Module. <p> The battery circuit breaker should be turned off whilst updating configurations (particularly when changing between battery and non-battery configurations).</p> <p>When reconnecting the battery always ensure that the BATTERY switch on the Electronics Module is off before the battery circuit breaker is turned on.</p> <p> All INTEGRA units are supplied with same default IP address settings (Router, Amplifier Frame and Network Card). Configuration and commissioning will not be possible if multiple units with same IP address are connected to the same Ethernet network. This includes VIPEDIA-12 and V2000 units.</p> <p>If there are multiple uncommissioned units in the system, power on and commission one unit at a time.</p> <p>Alternatively, ensure that only the target unit is connected to the Ethernet network.</p>
3.	The INTEGRA is ready for commissioning.
4.	Close and lock the unit’s door when commissioning is complete.

8 Connections

8.1 Field Termination Board

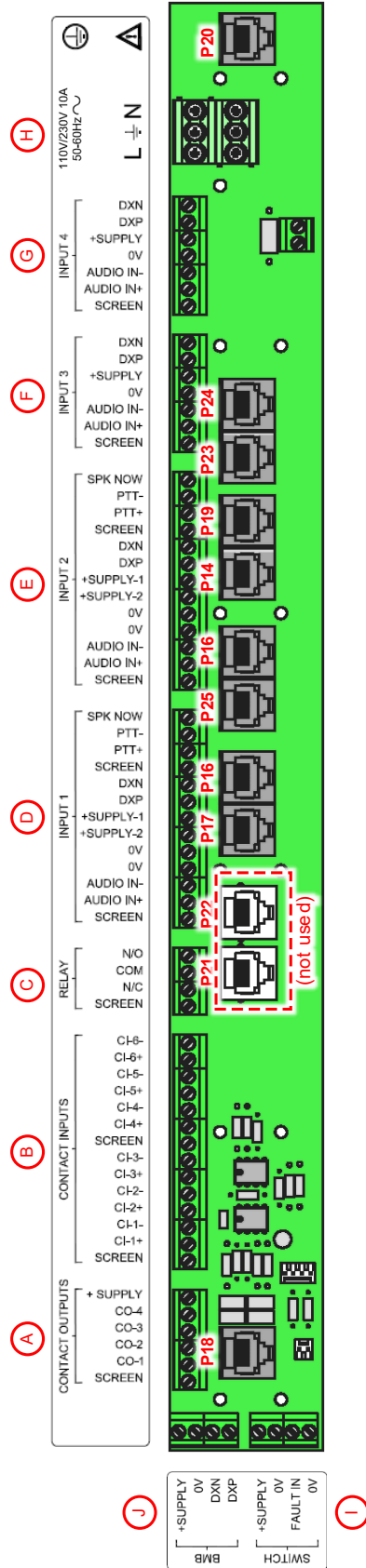

RJ45 connectors Pxx are used for internal wiring; see Section “ 7.10 Connecting the RJ45 Patch Leads to the Electronics Module (if removed)” (page 66) for connection details.

CONTACT OUTPUTS		
Screw Terminal	Description	Cabling
SCREEN	Cable screen	Type: Overall screened cable with required number of cores Recommended type: Suitably rated overall screened cable with required number of cores
CO-1	Open-drain output 1	
CO-2	Open-drain output 2	
CO-3	Open-drain output 3	
CO-4	Open-drain output 4	
+SUPPLY	+ve supply (as 18 V-40 V power supply input, fused at 200 mA) for open-drain outputs	
1) Maximum Rated Current per output: 350 mA 2) Maximum Voltage per output: 60 V.		

CONTACT INPUTS		
Screw Terminal	Description	Cabling
SCREEN	Cable screen	Type: Overall screened cable with required number of cores Recommended type: Suitably rated overall screened cable with required number of cores
CI-1+	Opto-coupled / Analogue input 1 (+ve)	
CI-1-	Opto-coupled input 1 (-ve)	
CI-2+	Opto-coupled / Analogue input 2 (+ve)	
CI-2-	Opto-coupled input 2 (-ve)	
CI-3+	Opto-coupled / Analogue input 3 (+ve)	
CI-3-	Opto-coupled input 3 (-ve)	
SCREEN	Cable screen	
CI-4+	Opto-coupled / Analogue input 4 (+ve)	
CI-4-	Opto-coupled input 4 (-ve)	
CI-5+	Opto-coupled / Analogue input 5 (+ve)	
CI-5-	Opto-coupled input 5 (-ve)	
CI-6+	Opto-coupled / Analogue input 6 (+ve)	
CI-6-	Opto-coupled input 6 (-ve)	
1) Internal 4k7Ω pull-up (configurable per group of 4 x contact inputs). 2) Opto-coupled interfaces for level conversion have built-in resistor to suit voltages of +12 to +40 V. The opto-coupled interfaces provide an internal resistance to ground of approximately 100 kΩ which may cause Fire Alarm Panels connected via the voltage-reversal method to report earth leakage faults. For all applications that require a voltage-reversal interface with the Fire Alarm Panel, ASL recommend that an ASL BMB01 Remote I/O Unit is used in order to avoid the possibility of earth leakage faults being reported by the Fire Alarm Panel.		

RELAY: Fault Relay		
Screw Terminal	Description	Cabling
SCREEN	Cable screen	Type: 1 x 3-core, screened Recommended type: Suitably rated overall screened cable with required number of cores
N/C	Fault relay N/C contact	
COM	Fault relay COM contact	
N/O	Fault relay N/O contact (closed in normal operation, open on fault)	

INPUT 1 / INPUT 2: Audio Input, Serial Interface and Hardware Bypass				
Screw Terminal	Description	Cabling		
SCREEN	Cable screen			
AUDIO IN+	Balanced Audio Input (+ve)	Type for emergency microphone: 1 x 2-core, screened Type for non-emergency microphone: 1 x twisted pair, overall screened	Suggested type for emergency microphone: Fire rated equivalent cables such as Prysmian FP200 (LSF Low Smoke and Fume) Suggested type for non-emergency microphone: Standard overall screened CAT5 FTP or STP	
AUDIO IN-	As above but -ve			
0V	0 V supply	Type for emergency microphone: 2 x2-core, screened		
0V	0 V supply			
+SUPPLY-2	+V DC supply output (as 18 V-40 V power supply input) (from Router Contact Output +Supply)	Type for non-emergency microphone: 2 x twisted pairs, overall screened		
+SUPPLY-1	+V DC supply output (as 18 V-40 V power supply input) (from Router Input 1/2)			
DXP	Microphone control data EIA RS485 19200 baud (Data+)	Type for emergency microphone: 1 x 2-core, screened		
DXN	As above but Data-	Type for non-emergency microphone: 1 x twisted pair, overall screened		
SCREEN	Cable screen			
PTT+	Fire microphone PTT+ (Push -To-Talk)	Type: 1 x 3-core, screened		
PTT-	As above but PTT-			
SPK NOW	Fire Microphone Speak Now LED			

INPUT 3 / INPUT 4: Audio Input and Serial Interface			
Screw Terminal	Description	Cabling	
SCREEN	Cable screen		
AUDIO IN+	Balanced Audio Input (+ve)	Type: 1 x twisted pair, overall screened	Suggested type: Standard overall screened CAT5 FTP or STP
AUDIO IN-	As above but -ve		
0V	0 V supply	Type: 1 x twisted pair, overall screened	
+SUPPLY	+V DC supply output (as 18 V-40 V power supply input) (from Router Input 3/4)		
DXP	Microphone control data EIA RS485 19200 baud (Data+)	Type: 1 x twisted pair, overall screened	
DXN	As above but Data-		

Mains Power Supply IEC 60445 Terminal Marking and Wiring Colours					
Ⓜ	Screw Terminal		Wiring Colours	Description	Cabling
	L	Live	Brown	230 V AC +25% / -16% 110 V AC +10% / -15% T10A H 250 V fuse 50/60 Hz	Type: 1 x 3-core mains standard cable, 15 A current rating (110 V / 230 V) Suggested type: Suitably rated 3-core mains cable such as Niltox LF-319 (LSHF)
	Ⓧ (back box)	Protective Earth	Green/Yellow		
	N	Neutral	Blue		
	 (Field Termination Board)	Earth	Green/Yellow	Grounding	

SWITCH: Network Switch			
Ⓜ	Screw Terminal	Description	Cabling
	+SUPPLY	Power supply input (from Router Input 4 as 18-40 V supply input of the Router)	Type: 1 x 2-core Suggested type: 1 mm ² tri-rated 2-core cable
	0V	0 V power supply input	
	FAULT IN	Switch fault input	Type: 1 x 2-core, overall screened Suggested type: 1 mm ² tri-rated 2-core cable
	0V	0 V fault input	

BMB: BMB01 Remote I/O Unit			
Ⓜ	Screw Terminal	Description	Cabling
	+SUPPLY	Power supply input (from Router Input 4 as 18-40 V supply input of the Router)	Type: 1 x 2-core Suggested type: 1 mm ² tri-rated 2-core cable
	0V	0 V power supply input	
	DXN	BMB control data / EIA RS485 9600 baud (Data-)	Type: 1 x 2-core, overall screened Suggested type: 1 mm ² tri-rated 2-core overall screened cable
	DXP	As above but Data+	

① 18V-40V: Dual DC Power Supply (internal wiring)

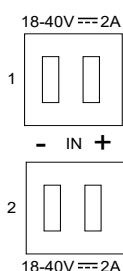

18V-40V: 2-way pluggable Wago cage clamp terminal (male)	
Signal	Description
+	+V supply (18 V to 40 V DC)
-	0 V supply

Cabling	
Type	1 x 2-core
Termination	2-way pluggable WAGO cage clamp terminal (5.08 mm) (female)
Suggested type	Suitably rated 2-core cable.

② CONTACTS OUT 1-6 and 7-12: Contact Outputs 1 to 12

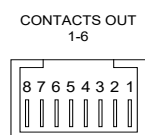

CONTACT OUTS 1-6: Standard RJ45 socket (internal wiring)			
Pin	CAT5 Cable (T568B)	Signal	Description
1	white/orange	CO-1	Open-drain output 1
2	orange	CO-2	Open-drain output 2
3	white/green	CO-3	Open-drain output 3
4	blue	CO-5	INTEGRA Fan Control (internal use only)
5	white/blue	CO-6	INTEGRA Fan Control (internal use only)
6	green	CO-4	Open-drain output 4
7	white/brown	+SUPPLY	+ve supply (as 18V-40V power supply input) (1.6 A) for open-drain outputs
8	brown	+SUPPLY	+ve supply (as 18V-40V power supply input) (1.6 A) for open-drain outputs

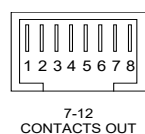

CONTACT OUTS 7-12: Standard RJ45 socket			
Pin	CAT5 Cable (T568B)	Signal	Description
1	white/orange	CO-7	Open-drain output 7
2	orange	CO-8	Open-drain output 8
3	white/green	CO-9	Open-drain output 9
4	blue	CO-11	Open-drain output 11
5	white/blue	CO-12	Open-drain output 12
6	green	CO-10	Open-drain output 10
7	white/brown	+SUPPLY	+ve supply (as 18V-40V power supply input) (1.6 A) for open-drain outputs
8	brown	+SUPPLY	+ve supply (as 18V-40V power supply input) (1.6 A) for open-drain outputs

- ③
- 1) Maximum Rated Current per output: 350 mA / Maximum Voltage per output: 60 V.
 - 2) Contact outputs 1 to 4 are available on the Field Termination Board.
 - 3) Contact outputs 5 and 6 are for internal use only (back box fans).
 - 4) Contact outputs 7 and 12 are not available on the Field Termination Board.
 - 5) Supply for internal use only.

Cabling	
Type	Overall screened cable with required number of cores
Termination	Screw terminals or RJ45
Suggested type	Suitably rated overall screened cable with required number of cores.

③ **DIAG.: USB Port (if Network Card is fitted)**

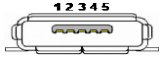

Standard USB Micro-AB socket		
Pin No.	Signal	Description
1	VBUS	+ V Supply (output)
2	D-	Data-
3	D+	Data+
4	ID	Permits distinction of host connection from slave connection: <ul style="list-style-type: none"> • Host: connected to Signal ground • Slave: not connected
5	GND	Signal ground

Cabling	
Type	Micro USB OTG serial data cable
Termination	USB Micro-AB
Suggested type	As required to connect to the external device being used.

④ **ETH3 and ETH4: 100BASE-T Ethernet Ports**

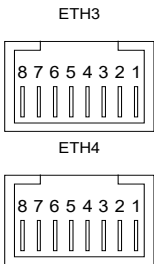

ETH3 and ETH4: Standard RJ45 socket			
Pin	CAT5 Cable (T568B)	Signal	Description
1	white/orange	TRANSMIT+	100BASE-T Ethernet Transmitted Data
2	orange	TRANSMIT-	Same as above
3	white/green	RECEIVE+	100BASE-T Ethernet Received Data
4	blue	-	Not used
5	white/blue	-	Not used
6	green	RECEIVE-	Same as above
7	white/brown	-	Not used
8	brown	-	Not used

Cabling	
Type	Standard LAN cable
Termination	RJ45
Suggested type	Must be CAT5 FTP or STP.

⑤ **ETH5 and ETH6: Optional Ethernet Ports (1 GigE)**

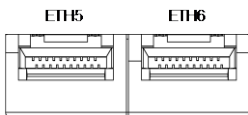

ETH5 and ETH6: SFP Cage (can be fitted with optional SFP modules)

- MM (multimode) module (LC duplex) (Cabling: per SFP module specification)
- SM (single mode) module (LC duplex) (Cabling: per SFP module specification)
- RJ45 (copper) module (Cabling: CAT5 FTP or STP standard cable)

⑥ **DBB IN 1 and OUT 1: Expansion Ports**

DBB IN 1

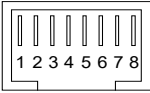
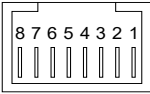

DBB OUT 1

These ports are not used in INTEGRA units at the time of publication of this document.

Cabling: Standard CAT5 FTP or STP cable must be used (maximum cable run = 4 m, entirely within the rack).

⑦ **ETH1 and ETH2: 100BASE-T Ethernet Ports**

ETH1

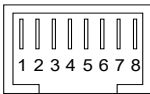
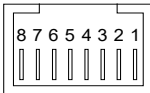

ETH2

ETH1 and ETH2: Standard RJ45 socket			
Pin	CAT5 Cable (T568B)	Signal	Description
1	white/orange	TRANSMIT+	100BASE-T Ethernet Transmitted Data
2	orange	TRANSMIT-	Same as above
3	white/green	RECEIVE+	100BASE-T Ethernet Received Data
4	blue	–	Not used
5	white/blue	–	Not used
6	green	RECEIVE-	Same as above
7	white/brown	–	Not used
8	brown	–	Not used

Cabling	
Type	Standard LAN cable
Termination	RJ45
Suggested type	Must be CAT5 FTP or STP.

⑧ **RS232: RS232 Port**

RS232

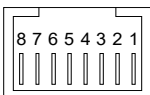

RS232: Standard RJ45 socket			
Pin	CAT5 Cable (T568B)	Signal	Description
1	white/orange	–	Not connected
2	orange	RX	RS232 Received Data (115200 baud)
3	white/green	TX	RS232 Transmitted Data (115200 baud)
4	blue	DTR	Data Terminal Ready
5	white/blue	GND	Common Ground
6	green	–	Not connected
7	white/brown	RTS	Request To Send
8	brown	CTS	Clear To Send

RS232 Port not available on the Field Termination Board.

Cabling	
Type	Serial data cable
Termination	RJ45
Suggested type	As required to connect to the external device being used.

⑨ **AMP CTRL: Audio-CAN and Amplifier Control Port (internal wiring)**

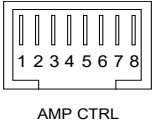

AMP CTRL: Standard RJ45 socket			
Pin	CAT5 Cable (T568B)	Signal	Description
1	white/orange	CAN_H	Not used
2	orange	CAN_L	Not used
3	white/green	GND	0 V Reference
4	blue	AUDIO MON+	Audio Monitor Bus (-10 dBu nominal) (+ve)
5	white/blue	AUDIO MON-	As above but -ve
6	green	GND	0 V Reference
7	white/brown	DXP	Not used
8	brown	DXN	Not used

Cabling	
Type	2 x twisted pairs, overall screened
Termination	Screw terminals or RJ45
Suggested type	Suitably rated overall screened cable (2 twisted pairs).

⑩ **CONTACTS IN 1-4, 5-8 and 9-12: Contact Inputs 1 to 12**

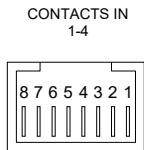

CONTACTS IN 1-4: Standard RJ45 socket (internal wiring)			
Pin	CAT5 Cable (T568B)	Signal	Description
1	white/orange	CI-1+	Opto-coupled input 1 (+ve) / Analogue input 1
2	orange	CI-1-	Opto-coupled input 1 (-ve)
3	white/green	CI-2+	Opto-coupled input 2 (+ve) / Analogue input 2
4	blue	CI-3+	Opto-coupled input 3 (+ve) / Analogue input 3
5	white/blue	CI-3-	Opto-coupled input 3 (-ve)
6	green	CI-2-	Opto-coupled input 2 (-ve)
7	white/brown	CI-4+	Opto-coupled input 4 (+ve) / Analogue input 4
8	brown	CI-4-	Opto-coupled input 4 (-ve)

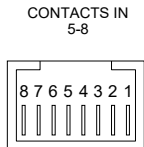

CONTACTS IN 5-8: Standard RJ45 socket (internal wiring)			
Pin	CAT5 Cable (T568B)	Signal	Description
1	white/orange	CI-5+	Opto-coupled input 5 (+ve) / Analogue input 5
2	orange	CI-5-	Opto-coupled input 5 (-ve)
3	white/green	CI-6+	Opto-coupled input 6 (+ve) / Analogue input 6
4	blue	CI-7+	Opto-coupled input 7 (+ve) / Analogue input 7
5	white/blue	CI-7-	Opto-coupled input 7 (-ve)
6	green	CI-6-	Opto-coupled input 6 (-ve)
7	white/brown	CI-8+	Opto-coupled input 8 (+ve) / Analogue input 8
8	brown	CI-8-	Opto-coupled input 8 (-ve)

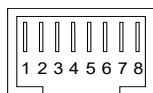

9-12 CONTACTS IN

CONTACTS IN 9-12: Standard RJ45 socket (internal wiring)			
Pin	CAT5 Cable (T568B)	Signal	Description
1	white/orange	CI-9+	Opto-coupled input 9 (+ve) / Analogue input 9 For internal use only: Network Switch Fault
2	orange	CI-9-	Opto-coupled input 9 (-ve) For internal use only
3	white/green	CI-10+	Opto-coupled input 10 (+ve) / Analogue input 10
4	blue	CI-11+	Opto-coupled input 11 (+ve) / Analogue input 11
5	white/blue	CI-11-	Opto-coupled input 11 (-ve)
6	green	CI-10-	Opto-coupled input 11 (-ve)
7	white/brown	CI-12+	Opto-coupled input 12 / Analogue input 12 (+ve)
8	brown	CI-12-	Opto-coupled input 12 (-ve)

- i**
- Contact inputs 1 to 6 are available on the Field Termination Board.
 - As standard, contact inputs 7 and 12 are not available for external usage. Contact input 9 is for internal use only (Network Switch fault input).
 - Internal 4k Ω pull-up (configurable per group of 4 x contact inputs).
 - Opto-coupled interfaces for level conversion have built-in resistor to suit voltages of +12 to +40 V. The opto-coupled interfaces provide an internal resistance to ground of approximately 100 k Ω which may cause Fire Alarm Panels connected via the voltage-reversal method to report earth leakage faults. For all applications that require a voltage-reversal interface with the Fire Alarm Panel, ASL recommend that an ASL BMB01 Remote I/O Unit is used in order to avoid the possibility of earth leakage faults being reported by the Fire Alarm Panel.

Cabling	
Type	Overall screened cable with required number of cores
Termination	Screw terminals or RJ45
Suggested type	Suitably rated overall screened cable with required number of cores.

11 CONTROL: Fault/Voice Alarm/Control Relays and ASL BMB01 Serial Interface

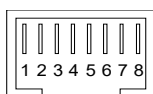

CONTROL

Standard RJ45 socket (internal wiring)			
Pin	CAT5 Cable (T568B)	Signal	Description
1	white/orange	Relay 1 N/C	Fault relay
2	orange	Relay 1 COM	
3	white/green	Relay 1 N/O	
4	blue	Relay 2 COM	Voice Alarm relay
5	white/blue	Relay 2 N/O	
6	green	Relay 2 N/C	
7	white/brown	BMB DXP	BMB control data / EIA RS485 9600 baud (Data+)
8	brown	BMB DXN	As above but Data-

- i**
- Relay 1 - Fault relay: NO contacts closed in normal operation, open on fault. Available on the Field Termination Board.
 - Relay 2 - Voice Alarm relay: NO contacts open in normal operation, closed on Voice Alarm. As standard, not available for external usage.
 - BMB control data available on the Field Termination Board.

Cabling	
Type	Overall screened cable with required number of cores
Termination	Screw terminals or RJ45
Suggested type	Relay: Suitably rated overall screened cable with required number of cores. BMB: 1 mm ² tri-rated 2-core overall screened cable.

12 AUDIO INPUTS 1 to 12: Audio Inputs and RS485 Serial Interfaces 1 to 12

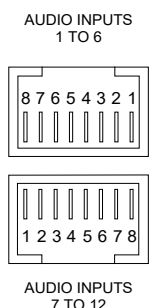

AUDIO INPUTS 1 to 12: Standard RJ45 socket			
Pin	CAT5 Cable (T568B)	Signal	Description
1	white/orange	AUDIO IN+	Balanced Audio Input (+ve)
2	orange	AUDIO IN-	Balanced Audio Input (-ve)
3	white/green	DXP	Microphone control data EIA RS485 19200 baud (Data+)
4	blue	+SUPPLY	+V DC supply output (as supply input) Fused at 350 mA per pair, i.e. inputs 1-2, 3-4, 5-6, 7-8, 9-10, and 11-12.
5	white/blue	+SUPPLY	Same as above
6	green	DXN	Microphone control data EIA RS485 19200 baud (Data-)
7	white/brown	0V	0 V supply
8	brown	0V	Same as above

- 1) Inputs 1 to 4 available on the Field Termination Board (including fire microphone connections for inputs 1 and 2) via internal wiring.
- 2) Inputs 5 to 12 not available on the Field Termination Board.

Cabling	
Type	Non-emergency microphones: twisted pair, overall screened. Emergency microphones: overall screened cable with required number of cores.
Termination	Screw terminals or RJ45
Suggested type	Non-emergency microphones: standard overall screened CAT5 FTP or STP. Emergency microphones: fire rated equivalent cables such as Prysmian FP200 (LSF Low Smoke and Fume).

13 AUDIO OUTPUTS 1-4, 5-8 and 9-12 (A&B): Audio Outputs 1 to 12 (A&B)

A
AUDIO OUTPUTS
1-4

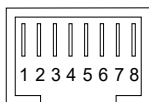
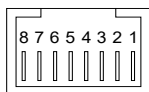

1-4
AUDIO OUTPUTS
B

AUDIO OUTPUTS 1-4 (A&B): Standard RJ45 socket (internal wiring)			
Pin	CAT5 Cable (T568B)	Signal	Description
1	white/orange	AUDIO OUT 1+	Balanced audio output 1 (+ve)
2	orange	AUDIO OUT 1-	Balanced audio output 1 (-ve)
3	white/green	AUDIO OUT 2+	Balanced audio output 2 (+ve)
4	blue	AUDIO OUT 3+	Balanced audio output 3 (+ve)
5	white/blue	AUDIO OUT 3-	Balanced audio output 3 (-ve)
6	green	AUDIO OUT 2-	Balanced audio output 2 (-ve)
7	white/brown	AUDIO OUT 4+	Balanced audio output 4 (+ve)
8	brown	AUDIO OUT 4-	Balanced audio output 4 (-ve)

A
AUDIO OUTPUTS
5-8

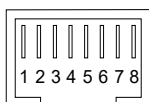
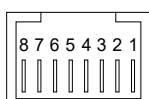

5-8
AUDIO OUTPUTS
B

AUDIO OUTPUTS 5-8 (A&B): Standard RJ45 socket (internal wiring)			
Pin	CAT5 Cable (T568B)	Signal	Description
1	white/orange	AUDIO OUT 5+	Balanced audio output 5 (+ve)
2	orange	AUDIO OUT 5-	Balanced audio output 5 (-ve)
3	white/green	AUDIO OUT 6+	Balanced audio output 6 (+ve)
4	blue	AUDIO OUT 7+	Balanced audio output 7 (+ve)
5	white/blue	AUDIO OUT 7-	Balanced audio output 7 (-ve)
6	green	AUDIO OUT 6-	Balanced audio output 6 (-ve)
7	white/brown	AUDIO OUT 8+	Balanced audio output 8 (+ve)
8	brown	AUDIO OUT 8-	Balanced audio output 8 (-ve)

A
AUDIO OUTPUTS
9-12

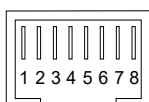
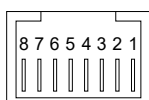

9-12
AUDIO OUTPUTS
B

AUDIO OUTPUTS 9-12 (A&B): Standard RJ45 socket (internal wiring)			
Pin	CAT5 Cable (T568B)	Signal	Description
1	white/orange	AUDIO OUT 9+	Balanced audio output 9 (+ve)
2	orange	AUDIO OUT 9-	Balanced audio output 9 (-ve)
3	white/green	AUDIO OUT 10+	Balanced audio output 10 (+ve)
4	blue	AUDIO OUT 11+	Balanced audio output 11 (+ve)
5	white/blue	AUDIO OUT 11-	Balanced audio output 11 (-ve)
6	green	AUDIO OUT 10-	Balanced audio output 10 (-ve)
7	white/brown	AUDIO OUT 12+	Balanced audio output 12 (+ve)
8	brown	AUDIO OUT 12-	Balanced audio output 12 (-ve)



As standard, AUDIO OUT 1-4, 5-8 and 9-12 ports of the Router are connected to 1-4, 5-8 and 9-12 IN ports of the Audio Interface Board (via patch leads). The Audio Interface Card then routes the Router audio outputs to amplifier slots and RJ45 ports as described in Table 1 (page 111).

Cabling	
Type	Twisted pairs, individually screened
Termination	Screw terminals or RJ45
Suggested type	Suitably rated cable with required number of pairs individually screened.

14 MIC AUX 1 / MIC AUX 2: Auxiliary Microphone Interface (Hardware Bypass Emergency Microphone and Listen-in Interfaces)

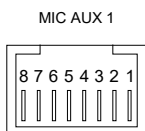

MIC AUX 1: Standard RJ45 socket (internal wiring)			
Pin	CAT5 Cable (T568B)	Signal	Description
1	white/orange	PTT2+	Fire/Emergency microphone 2 PTT+ (Push-To-Talk)
2	orange	PTT1+	Fire/Emergency microphone 1 PTT+ (Push -To-Talk)
3	white/green	LIST1+	Listen-in audio output 1+
4	blue	S-NOW1	Fire/Emergency Microphone 1 Speak Now LED
5	white/blue	S-NOW2	Fire/Emergency Microphone 2 Speak Now LED
6	green	LIST1-	Listen-in audio output 1-
7	white/brown	PTT2-	Fire/Emergency microphone 2 PTT- (Push -To-Talk)
8	brown	PTT1-	Fire/Emergency microphone 1 PTT- (Push -To-Talk)

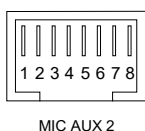

MIC AUX 2: Standard RJ45 socket (internal wiring)			
Pin	CAT5 Cable (T568B)	Signal	Description
1	white/orange	–	Not connected
2	orange	PTT2+	Fire/Emergency microphone 2 PTT+ (Push -To-Talk)
3	white/green	LIST2+	Listen-in audio output 2+
4	blue	S-NOW2	Fire/Emergency Microphone 2 Speak Now LED
5	white/blue	–	Not connected
6	green	LIST2-	Listen-in audio output 2-
7	white/brown	–	Not connected
8	brown	PTT2-	Fire/Emergency microphone 2 PTT- (Push -To-Talk)

- 1) Fire microphone connections available on the Field Termination Board.
 2) Listen-in not available on the Field Termination Board.

Cabling	
Type	PTT and Speak Now: 1 x 3-core, screened Listen-in (emergency microphones): 1 x 2-core, screened Listen-in (non-emergency microphones): 1 x twisted pair, overall screened
Termination	Screw terminals or RJ45
Suggested type	Emergency microphones: Fire rated equivalent cables such as Prysmian FP200 (LSF Low Smoke and Fume). Non-emergency microphones: Standard overall screened CAT5 FTP or STP.

8.2.2 Break-Out Adaptor (BOA) Connections



The Break-Out-Adaptors (BOA) can be used to provide screw termination for external wiring for any of the Router's RJ45 ports.

The following sections only describe the termination for the RJ45 ports that are not internally wired and, therefore, not available on the Field Termination Board. Please refer to the VIPEDIA-12 Installation Guide (ASL U-0641-0344) for details on other RJ45 port termination.

8.2.2.1 BOA01 Connections

Figure 2 BOA01 pinout

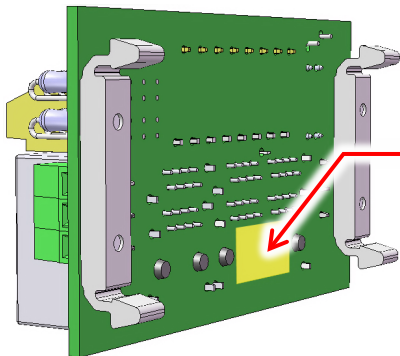
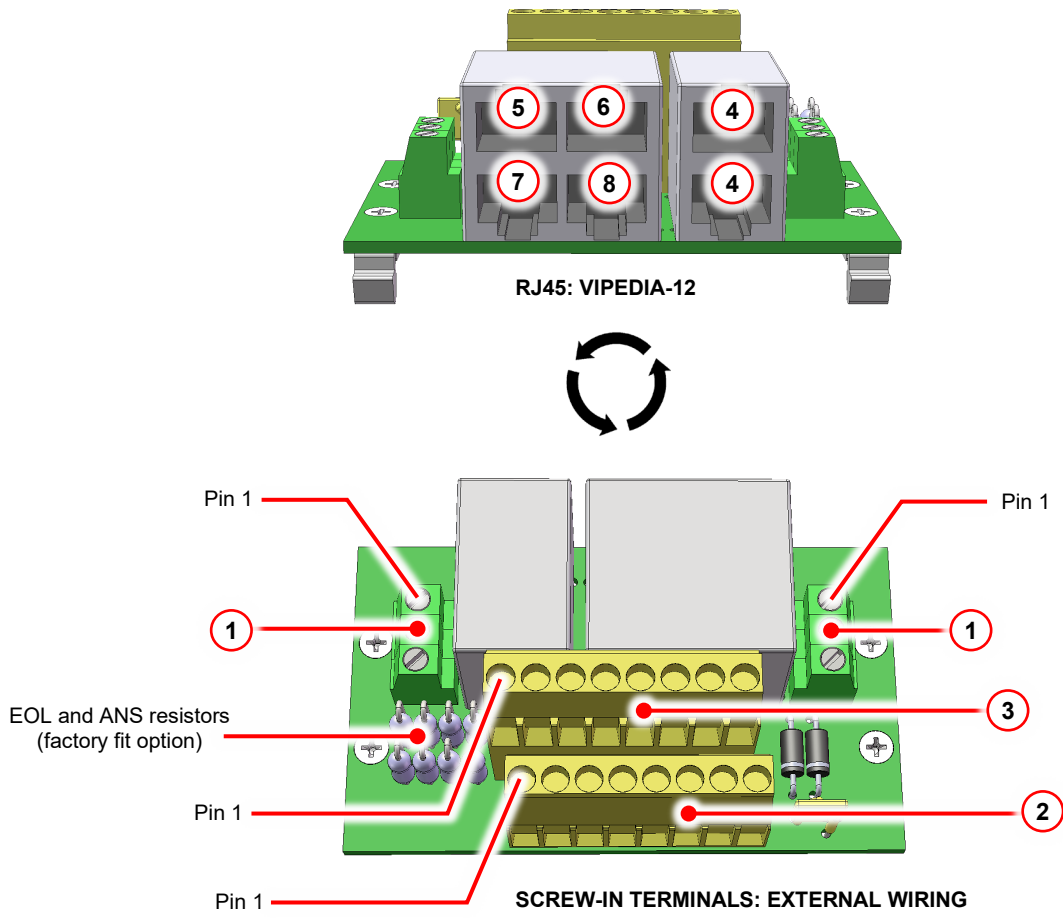

For EMC compliance, ensure that 20 mm length of EMC gasket¹ (provided) is fixed to the gold-plated PCB land.

Ensure that its compression to 5 mm high (to DIN rail) does not connect to other tracks on the PCB.

¹ Würth EMC gasket PN 3031010

8.2.2.1.1 BOA01 - Audio Input and Serial Interface (5 to 12) Connections

Field Connection				Connection to ROUTER (via CAT5 patch lead)			
Screw Terminal ①							
From external power supply	Description	Signal	Pin	Not applicable (Connected to screw terminal ③ via the PCB.)			
	+V supply input (18 – 40 V) / 500 mA	24 V	1				
	+V supply input (18 – 40 V) / 500 mA	24 V	2				
	0 V supply	0 V	3				
Screw Terminal ②				BOA01's RJ45 (see page 98) ④	ROUTER's RJ45 (see page 89) ⑫ INPUTS 5 to 12		
To/From external device (e.g. ASL microphone)	Description	Signal	Pin	Pin	T568B	Pin	
	Balanced audio input+	AUDIO IN+	1	1	WH/OR	1	
	Balanced audio input-	AUDIO IN-	2	2	OR	2	
	RS485 data+	DXP	3	3	WH/GR	3	
	RS485 data-	DXN	4	6	GR	6	
	DC supply output (18 – 40 V)	+SUPPLY	5	4	BL	4	
	DC supply output (18 – 40 V)	+SUPPLY	6	5	WH/BL	5	
	DC supply output (0 V)	0V	7	7	WH/BR	7	
	DC supply output (0 V)	0V	8	8	BR	8	
	Screw Terminal ③				Not applicable		
	Description	Signal	Pin				
	Cable screen	SCREEN	1				
DC supply output (18 – 40 V)	SUPPLY+	2					
Cable screen	SCREEN	3					
DC supply output (0 V)	0V	4					
Cable screen	SCREEN	5					
DC supply output (18 – 40 V)	SUPPLY+	6					
Cable screen	SCREEN	7					
DC supply output (0 V)	0V	8					
i	An external DC power supply (18 – 40 V) must be connected to screw terminal ① if a device is to be powered from the screw terminal block ③.						

8.2.2.1.2 BOA01 - Contact Outputs (7 to 12) Connections

Field Connection				Connection to ROUTER (via CAT5 patch lead)		
Screw Terminal ①						
From external power supply	Description	Signal	Pin	Not applicable (Connected to screw terminal ③ via the PCB.)		
	+V supply input (18 – 40 V) / 500 mA	24 V	1			
	+V supply input (18 – 40 V) / 500 mA	24 V	2			
	0 V supply	0 V	3			
To external device	Screw Terminal ②			BOA01's RJ45 (see page 98) ④	ROUTER's RJ45 (see page 89) ②	
	Description	Signal	Pin	Pin	T568B	Pin
	Open-drain output 7	CO-7	1	1	WH/OR	1
	Open-drain output 8	CO-8	2	2	OR	2
	Open-drain output 9	CO-9	3	3	WH/GR	3
	Open-drain output 10	CO-10	4	6	GR	6
	Open-drain output 11	CO-11	5	4	BL	4
	Open-drain output 12	CO-12	6	5	WH/BL	5
	+ve supply (as 18V-40 V power supply input) for open-drain outputs	+Supply	7	7	WH/BR	7
	+ve supply (as 18V-40 V power supply input) for open-drain outputs	+Supply	8	8	BR	8
	Screw Terminal ③			Not applicable		
	Description	Signal	Pin			
	Cable screen	SCREEN	1			
	DC supply output (18 – 40 V)	SUPPLY+	2			
	Cable screen	SCREEN	3			
DC supply output (0 V)	0V	4				
Cable screen	SCREEN	5				
DC supply output (18 – 40 V)	SUPPLY+	6				
Cable screen	SCREEN	7				
DC supply output (0 V)	0V	8				
	An external DC power supply (18 – 40 V) must be connected to screw terminal ① if a device is to be powered from the screw terminal block ③.					

8.2.2.1.3 BOA01 - RS232 Serial Port Connections

Field Connection				Connection to ROUTER (via CAT5 patch lead)			
Screw Terminal ①							
From external power supply	Description	Signal	Pin	Not applicable (Connected to screw terminal ③ via the PCB.)			
	+V supply input (18 – 40 V) / 500 mA	24 V	1				
	+V supply input (18 – 40 V) / 500 mA	24 V	2				
	0 V supply	0 V	3				
Screw Terminal ②				BOA01's RJ45 (see page 98) ④	ROUTER's RJ45 (see page 89) ⑧		
To/From external device	Description	Signal	Pin	Pin	T568B	Pin	
	Not connected	–	1	1	WH/OR	1	
	RS232 Received Data	RX	2	2	OR	2	
	RS232 Transmitted Data	TX	3	3	WH/GR	3	
	Not connected	–	4	6	GR	6	
	Data Terminal Ready	DTR	5	4	BL	4	
	Common Ground	GND	6	5	WH/BL	5	
	Request To Send	RTS	7	7	WH/BR	7	
	Clear To Send	CTS	8	8	BR	8	
	Screw Terminal ③				Not applicable		
	Description	Signal	Pin				
	Cable screen	SCREEN	1				
	DC supply output (18 – 40 V)	SUPPLY+	2				
Cable screen	SCREEN	3					
DC supply output (0 V)	0V	4					
Cable screen	SCREEN	5					
DC supply output (18 – 40 V)	SUPPLY+	6					
Cable screen	SCREEN	7					
DC supply output (0 V)	0V	8					
①				An external DC power supply (18 – 40 V) must be connected to screw terminal ① if a device is to be powered from the screw terminal block ③.			

8.2.2.1.4 BOA01 - Aggregating Audio Input (up to 4) Connections

Field Connection				Connection to ROUTER (via CAT5 patch lead)				
Screw Terminal ①								
From external power supply	Description	Signal	Pin	Not applicable (Connected to screw terminal ③ via the PCB.)				
	+V supply input (18 – 40 V) / 500 mA	24 V	1					
	+V supply input (18 – 40 V) / 500 mA	24 V	2					
	0 V supply	0 V	3					
To/From external device	Screw Terminal ②			BOA01's RJ45 (see page 98)			ROUTER's RJ45 (see page 89)	
	Description	Signal	Pin	RJ45	Pin	T568B	RJ45	Pin
	Balanced audio input 1+	AUDIO IN+	1	⑤	1	WH/OR	⑫ Any available I/P	1
	Balanced audio input 1-	AUDIO IN-	2		2	OR		2
	Balanced audio input 2+	AUDIO IN+	3	⑥	1	WH/OR	⑫ Any available I/P	1
	Balanced audio input 2-	AUDIO IN-	4		2	OR		2
	Balanced audio input 3+	AUDIO IN+	5	⑦	1	WH/OR	⑫ Any available I/P	1
	Balanced audio input 3-	AUDIO IN-	6		2	OR		2
	Balanced audio input 4+	AUDIO IN+	7	⑧	1	WH/OR	⑫ Any available I/P	1
	Balanced audio input 4-	AUDIO IN-	8		2	OR		2
	Screw Terminal ③			Not applicable				
	Description	Signal	Pin					
	Cable screen	SCREEN	1					
	DC supply output (18 – 40 V)	SUPPLY+	2					
	Cable screen	SCREEN	3					
DC supply output (0 V)	0V	4						
Cable screen	SCREEN	5						
DC supply output (18 – 40 V)	SUPPLY+	6						
Cable screen	SCREEN	7						
DC supply output (0 V)	0V	8						
 An external DC power supply (18 – 40 V) must be connected to screw terminal ① if a device is to be powered from the screw terminal block ③.								

8.2.2.2 BOA02 Connections

Figure 3 BOA02 pinout

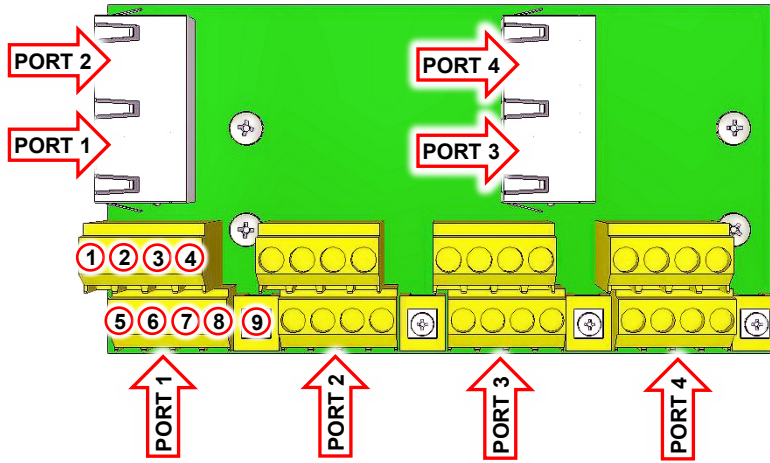

Screw-in Terminals		RJ45	
		Pin	T568-B
Rear	1	1	WH/OR
	2	2	OR
	3	3	WH/GR
	4	6	GR
Front	5	4	BL
	6	5	WH/BL
	7	7	WH/BR
	8	8	BR
9 (SCREEN)		-	

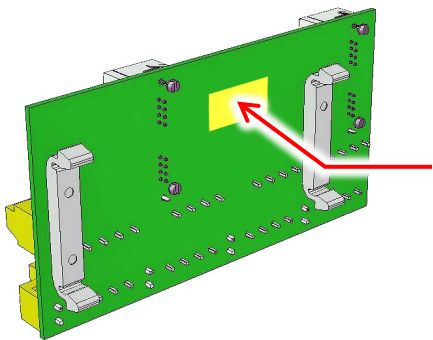

For EMC compliance, ensure that 20 mm length of EMC gasket¹ (provided) is fixed to the gold-plated PCB land.

Ensure that its compression to 5 mm high (to DIN rail) does not connect to other tracks on the PCB.

¹ Würth EMC gasket PN 3031010

8.2.2.2.1 BOA02 - Audio Input and Serial Interface (5 to 12) Connections

Field Connection				Connection to ROUTER (via CAT5 patch lead)		
To/From external device (e.g. ASL microphone)	Screw Terminal			BOA02's RJ45 (see page 103) PORT 1 to 4	ROUTER's RJ45 (see page 89) 12 INPUTS 5 to 12	
	Description	Signal	Pin		Pin	T568B
	Balanced audio input+	AUDIO IN+	1	1	WH/OR	1
	Balanced audio input-	AUDIO IN-	2	2	OR	2
	RS485 data+	DXP	3	3	WH/GR	3
	RS485 data-	DXN	4	6	GR	6
	DC supply output (18 – 40 V)	+SUPPLY	5	4	BL	4
	DC supply output (18 – 40 V)	+SUPPLY	6	5	WH/BL	5
	DC supply output (0 V)	0V	7	7	WH/BR	7
DC supply output (0 V)	0V	8	8	BR	8	

8.2.2.2.2 BOA02 - Contact Outputs (7 to 12) Connections

Field Connection				Connection to ROUTER (via CAT5 patch lead)		
To/From external device	Screw Terminal			BOA02's RJ45 (see page 103) PORT 1 to 4		ROUTER's RJ45 (see page 89) ②
				Description	Signal	Pin
	Open-drain output 7	CO-7	1	1	WH/OR	1
	Open-drain output 8	CO-8	2	2	OR	2
	Open-drain output 9	CO-9	3	3	WH/GR	3
	Open-drain output 10	CO-10	4	6	GR	6
	Open-drain output 11	CO-11	5	4	BL	4
	Open-drain output 12	CO-12	6	5	WH/BL	5
	+ve supply (as 18V-40 V power supply input) for open-drain outputs	+Supply	7	7	WH/BR	7
	+ve supply (as 18V-40 V power supply input) for open-drain outputs	+Supply	8	8	BR	8

8.2.2.2.3 BOA02 - RS232 Serial Port Connections

Field Connection				Connection to ROUTER (via CAT5 patch lead)		
To/From external device	Screw Terminal			BOA02's RJ45 (see page 103) PORT 1 to 4		ROUTER's RJ45 (see page 89) ⑧
				Description	Signal	Pin
	Not connected	–	1	1	WH/OR	1
	RS232 Received Data	RX	2	2	OR	2
	RS232 Transmitted Data	TX	3	3	WH/GR	3
	Not connected	–	4	6	GR	6
	Data Terminal Ready	DTR	5	4	BL	4
	Common Ground	GND	6	5	WH/BL	5
	Request To Send	RTS	7	7	WH/BR	7
	Clear To Send	CTS	8	8	BR	8

8.3.1 Frame Connectors

① BATTERY IN/OUT: Battery Supply Input and Charger Output (internal wiring)

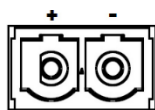

BATTERY IN/OUT
20-28V == 80A

Phoenix PC 16/
2-STF-10.16 (male)

Signal	Description
+	Battery positive input/output (21 - 28 V). External fusing of up to 80 A is required.
-	Battery negative input/output

Cabling	
Type	1 x 1-core red and 1 x 1-core black Current rating: 80 A / Min. size: 16 mm ² / Max. length: 1 m
Termination	Phoenix PC 16/ 2-STF-10,16 female connector (PHOENIX PN 1967456)
Suggested Type	Suitably rated 1-core cable (red and black) such as FS LF-249 (LSHF).

② AUX OUT / NTC PROBE: Auxiliary DC Supply Output and Thermistor Probe (internal wiring)



2-way 5.08 mm pitch plug
(Phoenix MSTB 2,5/ 2-ST-
5,08, male)

Connector	Signal	Description
AUX OUT	+	+V auxiliary DC output (20 - 29 V) / 2 A internal cut-off
	-	0 V supply
NTC PROBE		For connection of the thermistor lead assembly terminal. The polarity is not relevant when wiring the thermistor lead. Not used on INTEGRA.

AUX OUT Cabling	
Type	1 x 2-core
Termination	2-way 5.08 mm pitch plug (Phoenix MSTB 2,5/ 2-ST-5,08, female - PN 1757019)
Suggested Type	Suitably rated 2-core cable.

③ AC Mains Supply (internal wiring)

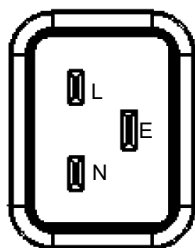

IEC 60320 C20 (male)

IEC 60445 – Conductor and Terminal Marking			
Marking		Wiring Colour	Description
L	Live	Brown	230 V AC +25% / -16% 110 V AC +10% / -15% T10A H 250 V fuse 50/60 Hz
E	Earth	Green / Yellow	
N	Neutral	Blue	

Cabling	
Type	1 x 3-core mains standard cable Current rating (110 V / 230 V): 15 A
Termination	IEC 60320 C19
Suggested Type	Suitably rated 3-core mains cable such as Niltox LF-319 (LSHF).

④ **CTRL 1 and CTRL 2: Audio-CAN, Amplifier Control Port and Relay (internal wiring)**

CTRL 1 (connected to Router's battery supply control circuit)			
Pin	CAT5 Cable (T568B)	Signal	Description
1	white/orange	CAN_H	Controller Area Network (High) (for future use)
2	orange	CAN_L	Same as above, but Low
3	white/green	GND	0 V Reference
4	blue	AUDIO MON+	Audio Monitor Bus (-10 dBu nominal, +ve)
5	white/blue	AUDIO MON-	As above, but -ve
6	green	Relay NO	Relay NO contact The heath relay is used to control the battery supply to the Router. Opens when battery voltage ≤ 21 V, closes again when battery voltage > 22 V.
7	white/brown	DXP	EIA RS485 38400 baud (Data+)
8	brown	DXN	As above, but Data-

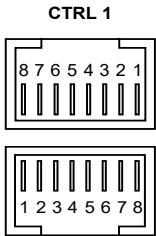

Standard RJ45 socket

CTRL 2 (connected to Router's AMP CTRL port via RJ45 patch lead)			
Pin	CAT5 Cable (T568B)	Signal	Description
1	white/orange	CAN_H	Controller Area Network (High) (for future use)
2	orange	CAN_L	Same as above, but Low
3	white/green	GND	0 V Reference
4	blue	AUDIO MON+	Audio Monitor Bus (-10 dBu nominal, +ve)
5	white/blue	AUDIO MON-	As above, but -ve
6	green	Relay COM	Relay COM contact (see NO above) Connected to ground via Router's AMP CTRL port.
7	white/brown	DXP	EIA RS485 38400 baud (Data+)
8	brown	DXN	As above, but Data-

Cabling	
Type	Twisted pairs, individually screened
Termination	RJ45 or screw terminals
Suggested Type	Suitably rated cable with required number of individually screened pairs.

⑤ **ETH1 and ETH2: 100BASE-T Ethernet Ports (internal wiring)**

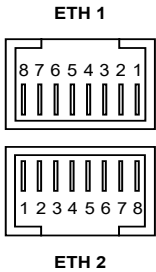

Standard RJ45 socket

Pin	CAT5 Cable (T568B)	Signal	Description
1	white/orange	TRANSMIT+	100BASE-T Ethernet Transmitted Data
2	orange	TRANSMIT-	Same as above
3	white/green	RECEIVE+	100BASE-T Ethernet Received Data
4	blue	–	Not used
5	white/blue	–	Not used
6	green	RECEIVE-	Same as above
7	white/brown	–	Not used
8	brown	–	Not used

Cabling	
Type	Standard LAN cable
Termination	RJ45
Suggested Type	CAT5 E

⑥ **USB Port (for future use)**



USB Micro-AB socket

Pin	Signal	Description
1	VBUS	+ V Supply (output)
2	D-	Data-
3	D+	Data+
4	ID	Permits distinction of host connection from slave connection: <ul style="list-style-type: none"> • Host: connected to Signal ground • Slave: not connected
5	GND	Signal ground

Cabling	
Type	Micro USB OTG serial data cable
Termination	USB Micro-AB
Suggested Type	As required to connect to the external device being used.

8.3.2 LSZDC Surveillance Interface Connectors

⑦ LINE OUT: Audio Output (external wiring)

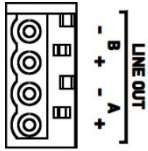

4-way pluggable Wago cage clamp (female)

Signal	Description	
A	+	100 V line audio output to speaker circuit A (+ve)
	-	As above, but -ve
B	+	100 V line audio output to speaker circuit B (+ve)
	-	As above, but -ve

The audio output is configurable to 100, 70 or 50 V RMS.

Cabling	
Type	1 x 2-core, twisted
Termination	4-way pluggable Wago cage clamp terminal (5.08 mm) (male)
Suggested Type	Suitably rated 2-core cable.

⑧ INPUT: Audio Input (internally wired by the Audio Interface Card)

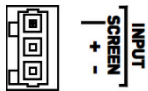

3-way pluggable Wago cage clamp (male)

Signal	Description
Screen	Cable screen
+	Balanced audio input at 0 dBu (+ve)
-	As above, but -ve

Cabling	
Type	1 x 2-core, twisted, screened
Termination	3-way pluggable Wago cage clamp terminal (3.81 mm) (female)
Suggested Type	Suitably rated 2-core cable.

8.3.3 Audio Interface Card Connectors

- ⑨ **1-4 IN and 1-4 OUT: Audio Inputs 1 to 4**
5-8 IN and 5-8 OUT: Audio Inputs 5 to 8
9-12 IN and 9-12 OUT: Audio Inputs 9 to 12

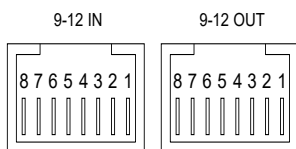
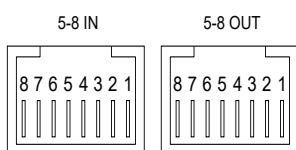
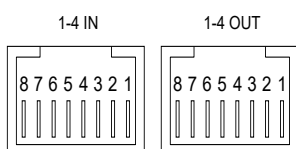

1-4 IN / 5-8 IN / 9-12 IN: Standard RJ45 socket			
Pin	CAT5 Cable (T568B)	Signal	Description
1	white/orange	AUDIO IN 1+ [5, 9]	Balanced audio input 1 (+ve)
2	orange	AUDIO IN 1- [5, 9]	Balanced audio input 1 (-ve)
3	white/green	AUDIO IN 2+ [6, 10]	Balanced audio input 2 (+ve)
4	blue	AUDIO IN 3+ [7, 11]	Balanced audio input 3 (+ve)
5	white/blue	AUDIO IN 3- [7, 11]	Balanced audio input 3 (-ve)
6	green	AUDIO IN 2- [6, 10]	Balanced audio input 2 (-ve)
7	white/brown	AUDIO IN 4+ [8, 12]	Balanced audio input 4 (+ve)
8	brown	AUDIO IN 4- [8, 12]	Balanced audio input 4 (-ve)

- For connection to local Router outputs (standard) as described in Table 1 (page 111).
- Can be used for daisy-chain connection to an OUT port of an Audio Interface Card.
- Numbers in brackets refer to 5-8 IN and 9-12 IN connectors.

1-4 OUT / 5-8 OUT / 9-12 OUT: Standard RJ45 socket			
Pin	CAT5 Cable (T568B)	Signal	Description
1	white/orange	AUDIO OUT 1+ [5, 9]	Balanced audio output 1 (+ve)
2	orange	AUDIO OUT 1- [5, 9]	Balanced audio output 1 (-ve)
3	white/green	AUDIO OUT 2+ [6, 10]	Balanced audio output 2 (+ve)
4	blue	AUDIO OUT 3+ [7, 11]	Balanced audio output 3 (+ve)
5	white/blue	AUDIO OUT 3- [7, 11]	Balanced audio output 3 (-ve)
6	green	AUDIO OUT 2- [6, 10]	Balanced audio output 2 (-ve)
7	white/brown	AUDIO OUT 4+ [8, 12]	Balanced audio output 4 (+ve)
8	brown	AUDIO OUT 4- [8, 12]	Balanced audio output 4 (-ve)

- For daisy-chain connection to an IN port of an Audio Interface Card; see Table 2 (page 112).
- Numbers in brackets refer to 5-8 IN and 9-12 IN connectors.

Cabling	
Type	Twisted pairs, individually screened
Termination	RJ45 or screw terminals
Suggested Type	Suitably rated cable with required number of pairs individually screened.

Table 1 Standard Router output to amplifier slot connection via Audio Interface Card











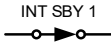
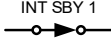
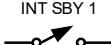
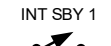
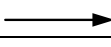
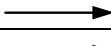
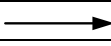
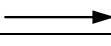
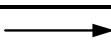
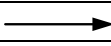

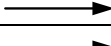
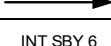
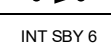
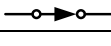
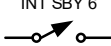
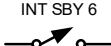
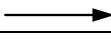
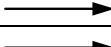
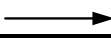
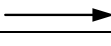

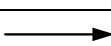
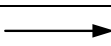
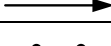
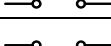
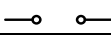
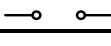

Router			Patch Lead	Audio Interface Card			PCB	LSZDC		
RJ45	Pin	Signal		RJ45	Pin	Signal		Amplifier Slot		
AUDIO OUTPUTS 1-4	1	AUDIO OUT 1+		1-4 IN	1	AUDIO OUT 1+		Slot 1 IN (+)	Working	
	2	AUDIO OUT 1-			2	AUDIO OUT 1-		Slot 1 IN (-)		
							or			
					AUDIO OUT 1+	AUDIO OUT 1+		Not routed	Standby	
					AUDIO OUT 1-	AUDIO OUT 1-		Not routed		
	3	AUDIO OUT 2+			3	AUDIO OUT 2+		Slot 2 IN (+)	Working	
	6	AUDIO OUT 2-			6	AUDIO OUT 2-		Slot 2 IN (-)		
	4	AUDIO OUT 3+			4	AUDIO OUT 3+		Slot 3 IN (+)	Working	
5	AUDIO OUT 3-	5	AUDIO OUT 3-		Slot 3 IN (-)					
7	AUDIO OUT 4+	7	AUDIO OUT 4+		Slot 4 IN (+)	Working				
8	AUDIO OUT 4-	8	AUDIO OUT 4-		Slot 4 IN (-)					
AUDIO OUTPUTS 5-8	1	AUDIO OUT 5+		5-8 IN	1	AUDIO OUT 5+		Slot 5 IN (+)	Working	
	2	AUDIO OUT 5-			2	AUDIO OUT 5-		Slot 5 IN (-)		
	3	AUDIO OUT 6+			3	AUDIO OUT 6+		Slot 6 IN (+)	Working	
	6	AUDIO OUT 6-			6	AUDIO OUT 6-		Slot 6 IN (-)		
							or			
					AUDIO OUT 6+	AUDIO OUT 6+		Not routed	Standby	
					AUDIO OUT 6-	AUDIO OUT 6-		Not routed		
	4	AUDIO OUT 7+			4	AUDIO OUT 7+		Slot 7 IN (+)	Working	
5	AUDIO OUT 7-	5	AUDIO OUT 7-		Slot 7 IN (-)					
7	AUDIO OUT 8+	7	AUDIO OUT 8+		Slot 8 IN (+)	Working				
8	AUDIO OUT 8-	8	AUDIO OUT 8-		Slot 8 IN (-)					
AUDIO OUTPUTS 9-12	1	AUDIO OUT 9+		9-12 IN	1	AUDIO OUT 9+		Slot 9 IN (+)	Working	
	2	AUDIO OUT 9-			2	AUDIO OUT 9-		Slot 9 IN (-)		
	3	AUDIO OUT 10+			3	AUDIO OUT 10+		Slot 10 IN (+)	Working	
	6	AUDIO OUT 10-			6	AUDIO OUT 10-		Slot 10 IN (-)		
	4	AUDIO OUT 11+			4	AUDIO OUT 11+		Not routed		
	5	AUDIO OUT 11-			5	AUDIO OUT 11-		Not routed		
	7	AUDIO OUT 12+			7	AUDIO OUT 12+		Not routed		
	8	AUDIO OUT 12-			8	AUDIO OUT 12-		Not routed		
Patch lead										
 Factory fit yellow RJ45 patch lead or installed as part of the INTEGRA installation.										
INT SBY switches										
		DOWN (towards the back box)			Amplifier Type					
		UP (towards the front door)			Slot fitted with a working amplifier (or empty)					
					Slot fitted with a standby amplifier (or empty)					

Table 2 Standard Router output to Audio Interface Card IN to OUT port connections

Router			Patch Lead	Audio Interface Card							
RJ45	Pin	Signal		RJ45	Pin	Signal	PCB	Pin	EIA-568-B	Signal	RJ45
AUDIO OUTPUTS 1-4	1	AUDIO OUT 1+		1-4 IN	1	AUDIO OUT 1+		1	WH/OR	AUDIO OUT 1+	1-4 OUT
	2	AUDIO OUT 1-			2	AUDIO OUT 1-		2	OR	AUDIO OUT 1-	
	3	AUDIO OUT 2+			3	AUDIO OUT 2+		3	WH/GR	AUDIO OUT 2+	
	6	AUDIO OUT 2-			6	AUDIO OUT 2-		6	GR	AUDIO OUT 2-	
	4	AUDIO OUT 3+			4	AUDIO OUT 3+		4	BL	AUDIO OUT 3+	
	5	AUDIO OUT 3-			5	AUDIO OUT 3-		5	WH/BL	AUDIO OUT 3-	
	7	AUDIO OUT 4+			7	AUDIO OUT 4+		7	WH/BR	AUDIO OUT 4+	
	8	AUDIO OUT 4-			8	AUDIO OUT 4-		8	BR	AUDIO OUT 4-	
AUDIO OUTPUTS 5-8	1	AUDIO OUT 5+		5-8 IN	1	AUDIO OUT 5+		1	WH/OR	AUDIO OUT 5+	5-6 OUT
	2	AUDIO OUT 5-			2	AUDIO OUT 5-		2	OR	AUDIO OUT 5-	
	3	AUDIO OUT 6+			3	AUDIO OUT 6+		3	WH/GR	AUDIO OUT 6+	
	6	AUDIO OUT 6-			6	AUDIO OUT 6-		6	GR	AUDIO OUT 6-	
	4	AUDIO OUT 7+			4	AUDIO OUT 7+		4	BL	AUDIO OUT 7+	
	5	AUDIO OUT 7-			5	AUDIO OUT 7-		5	WH/BL	AUDIO OUT 7-	
	7	AUDIO OUT 8+			7	AUDIO OUT 8+		7	WH/BR	AUDIO OUT 8+	
	8	AUDIO OUT 8-			8	AUDIO OUT 8-		8	BR	AUDIO OUT 8-	
AUDIO OUTPUTS 9-12	1	AUDIO OUT 9+		9-12 IN	1	AUDIO OUT 9+		1	WH/OR	AUDIO OUT 9+	9-12 OUT
	2	AUDIO OUT 9-			2	AUDIO OUT 9-		2	OR	AUDIO OUT 9-	
	3	AUDIO OUT 10+			3	AUDIO OUT 10+		3	WH/GR	AUDIO OUT 10+	
	6	AUDIO OUT 10-			6	AUDIO OUT 10-		6	GR	AUDIO OUT 10-	
	4	AUDIO OUT 11+			4	AUDIO OUT 11+		4	BL	AUDIO OUT 11+	
	5	AUDIO OUT 11-			5	AUDIO OUT 11-		5	WH/BL	AUDIO OUT 11-	
	7	AUDIO OUT 12+			7	AUDIO OUT 12+		7	WH/BR	AUDIO OUT 12+	
	8	AUDIO OUT 12-			8	AUDIO OUT 12-		8	BR	AUDIO OUT 12-	

Patch lead

 Factory fit yellow RJ45 patch lead or installed as part of the INTEGRA installation.

8.3.4 V2000-STBY Standby Interface Card Connectors

⑩ LOW LEVEL STANDBY LINK: Low Level Standby Link

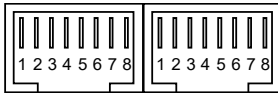

LOW LEVEL STANDBY LINK

Dual RJ45 socket

Pin	CAT5 Cable (T568B)	Signal		Description
1	orange/white	+	Standby I/P	Balanced audio input to standby amplifier at 0 dBu (+ve)
2	orange	-	Standby I/P	As above, but -ve
3	green/white	-		Not used
4	blue	-		Not used
5	blue/white	-		Not used
6	green	Standby lockout		For future use
7	brown/white	-		Not used
8	brown	-		Not used

Two sets of connections are provided for daisy-chain wiring from frame to frame.

Cabling	
Type	Overall foil screened
Termination	RJ45
Suggested Type	CAT5 STP or FTP LSZH

⑪ STANDBY 100V IN: Audio from Standby Amplifier

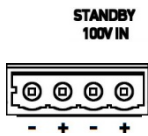

4-way pluggable Wago cage clamp (male)

Signal	Description
+	100 V line audio from standby amplifier (+ve)
-	As above, but -ve

Two sets of connections are provided for daisy-chain wiring from amplifier to amplifier.

Cabling	
Type	1 x 2-core, twisted, screened
Termination	4-way pluggable Wago cage clamp terminal (5.08 mm) (female)
Suggested Type	Suitably rated 2-core cable.

8.4 Expansion Unit / DBB Group Connection

Not supported at the time of publication of this document.

8.5 BMB01 Connection to INTEGRA

Figure 4 Wiring between a BMB01 and the Field Termination Board

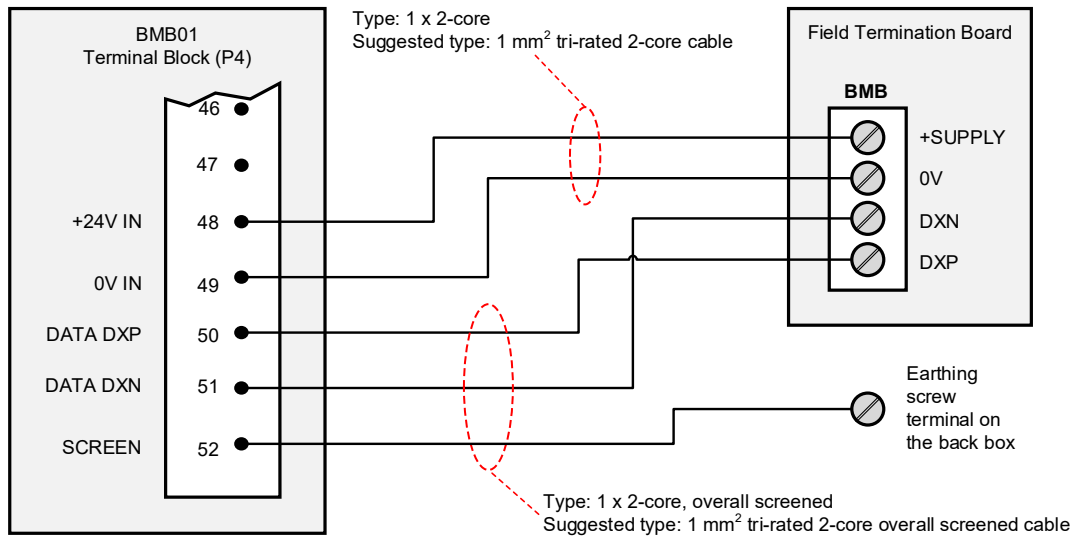

8.6 Hirschmann Network Switch Connection to INTEGRA

Figure 5 Wiring and cabling between the Hirschmann Network Switch RS20-04 and the Field Termination Board and Router

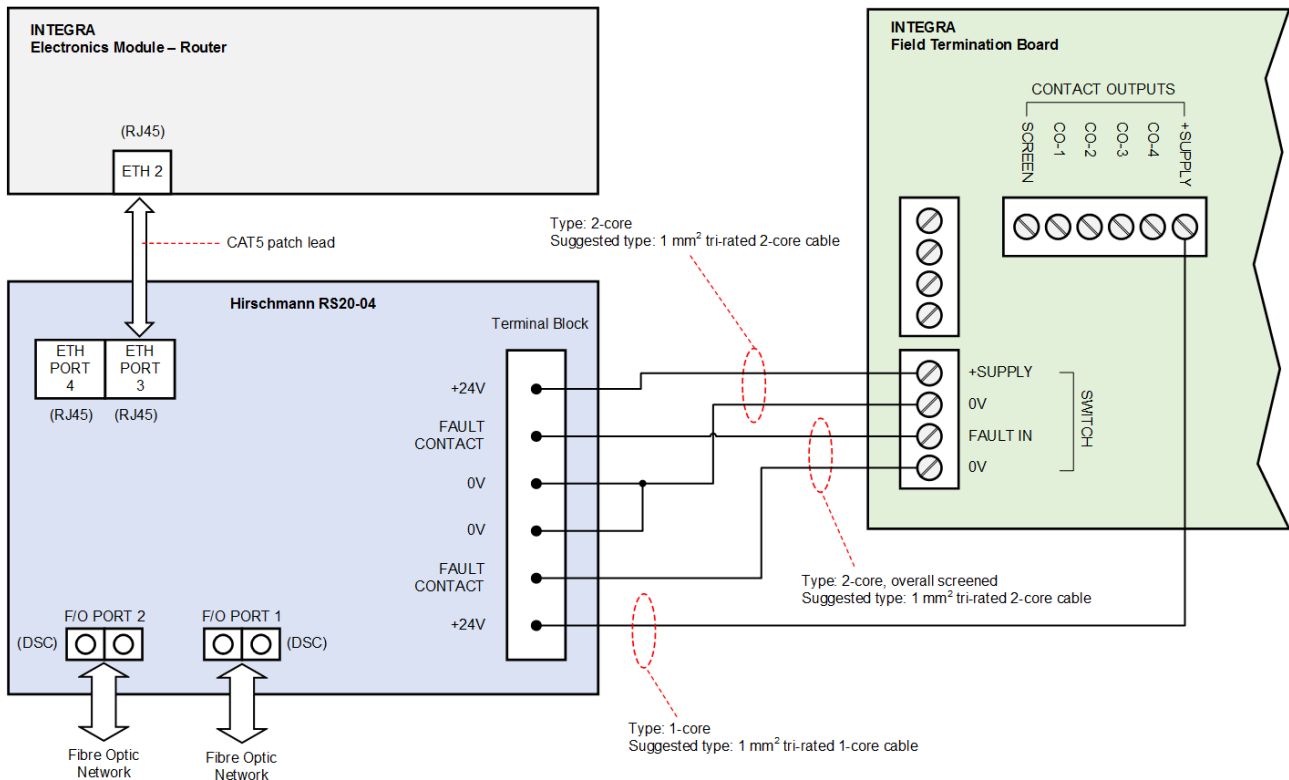

Note:

INTEGRA-PRO units may be supplied with the required wiring and a CAT5 patch lead.

8.7 EMS Fire Microphone Connection to INTEGRA

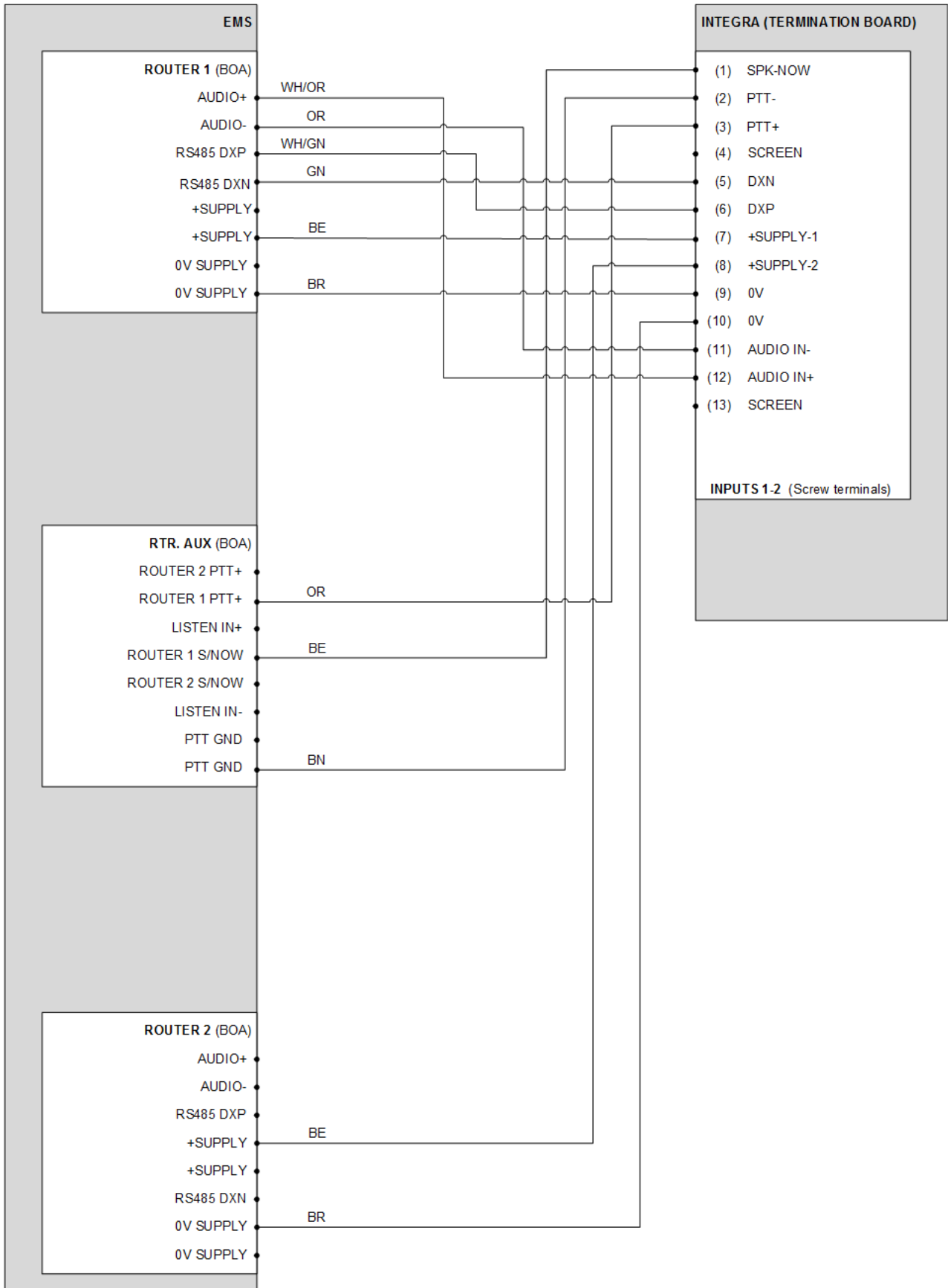

8.8 MPS Fire and Paging Microphone Connection to INTEGRA

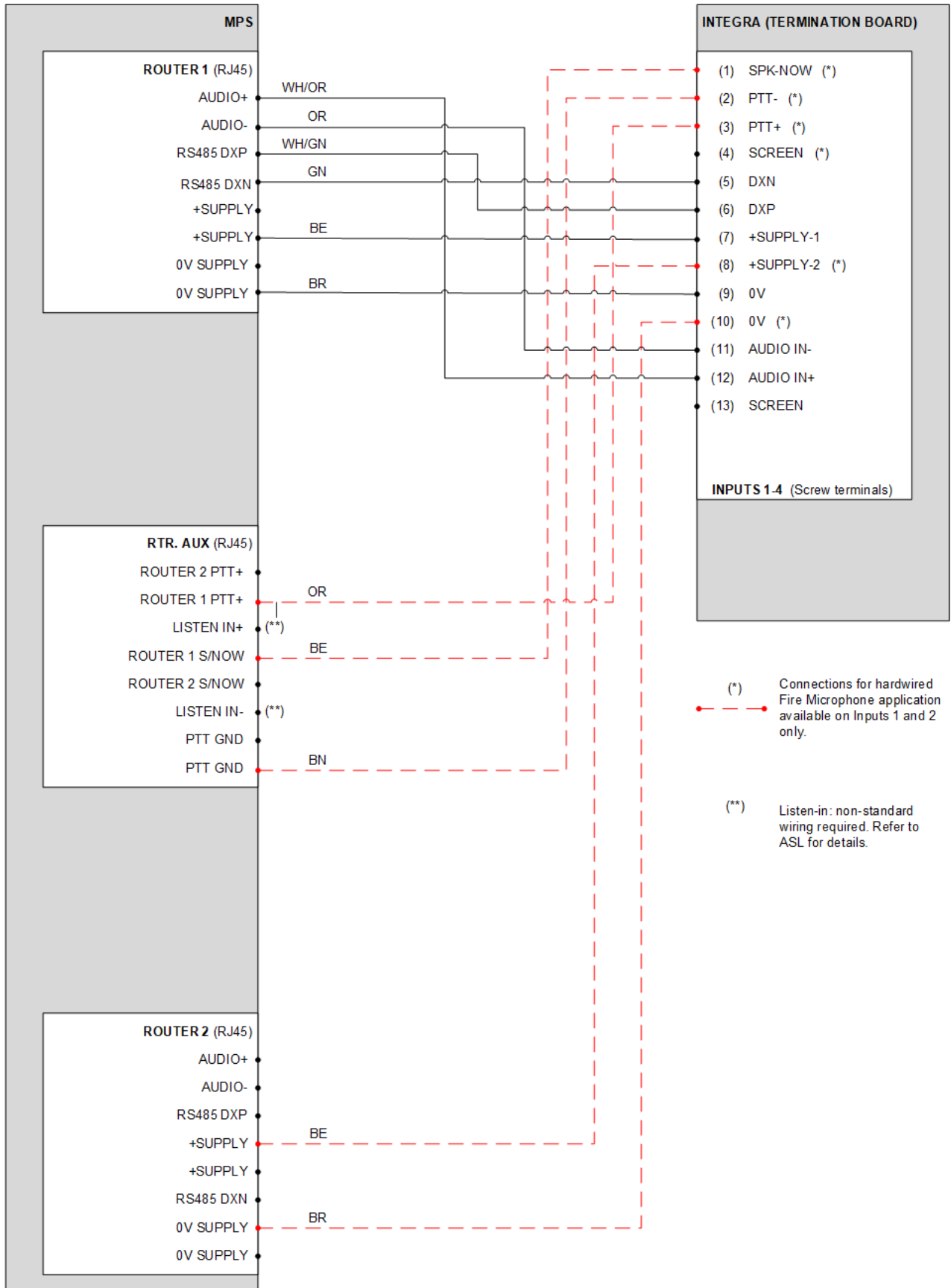

8.9 EAP01 Fire Microphone Connection to INTEGRA

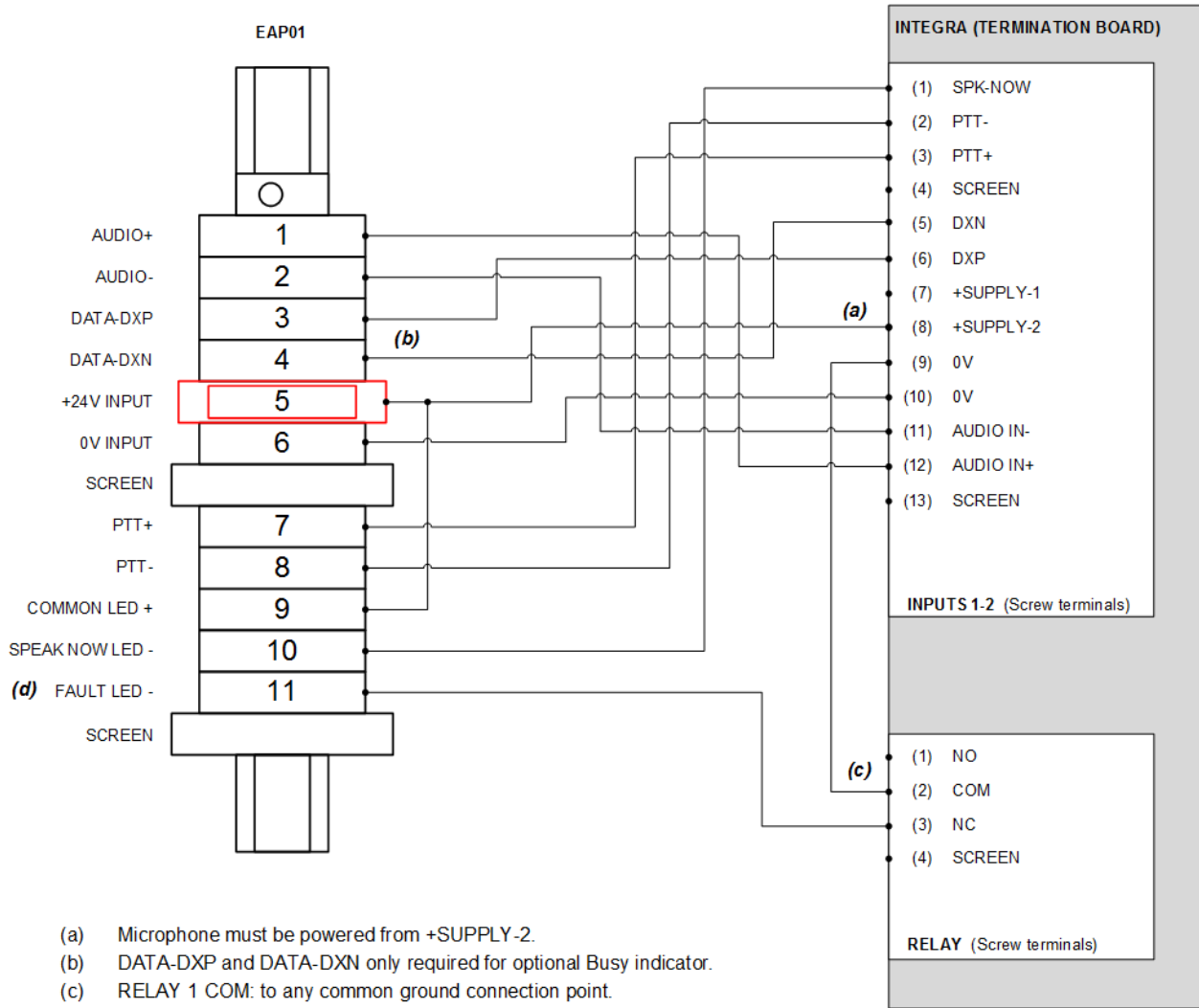

9 Technical Specification

9.1 General¹

Supply Voltage ²	230 V AC +25% / -16%, 110 V AC +10% / -15%, T10A H 250 V Fuse, 50/60 Hz
Inrush Current (worst case)	21 A
Maximum AC VA Rating (50% full power sinewave).....	2300 VA (230 V AC Supply Voltage) 1000 VA (110 V AC Supply Voltage)
Maximum AC Power Consumption (1 minute max.)	3900 VA (230 V AC Supply Voltage) 1750 VA (110 V AC Supply Voltage) with V2000 fully configured and all amplifier modules delivering 100 V 1 kHz sinewave into rated resistive loads
Auxiliary DC Supply Output	
DC Supply Voltage	20 V to 29 V depending on AC or DC supply, and battery conditions 2.5 A internal cut-off
Rated Continuous Maximum Output Current ($I_{max.a}$).....	2 A
Minimum Loading of the Equipment (I_{min}).....	0 A
Frame DC Supply Input/Output (Charger)	
Input/Output Voltage.....	21 to 28 V (from/to nominal 24 V lead acid battery pack)
Maximum value of internal battery resistance for which unit functionality can be maintained ($R_{i,max}$).....	60 m Ω
Maximum Battery Charging Current.....	3 A
Charging Time ³	less than 24 hours to charge to 80% capacity less than 72 hours to charge to 100% capacity
Temperature Compensation ³	-24 mV/ $^{\circ}$ C
Router DC Supply Input..... dual 18 V to 40 V DC (2 A)	
Input 1.....	21 to 28 V (from battery pack) / T3.15 A fuse (20 mm)
Input 2.....	20 V to 29 V (from Frame Auxiliary DC Supply Output)
Quiescent DC Current Consumption (at 24 V supply, excluding microphones and other accessories)	
LCD display backlight off, front panel LEDs off, sounder off, no amplifiers	525 mA
Network Card.....	additional 145 mA
Network Switch.....	additional 321 mA
BMB01 (excluding power supply output).....	additional 70 mA
SFP Module	additional 30 mA per module
Dante Brooklyn II Module	additional 60 mA
Maximum DC Current Consumption (at 21 V supply, excluding microphones and other accessories)	
LCD display backlight on, front panel LEDs on, sounder on.....	652 mA
Network Card.....	additional 166 mA
Network Switch.....	additional 367 mA
BMB01 (excluding power supply output).....	additional 80 mA
SFP Module	additional 35 mA per module
Dante Brooklyn II Module	additional 69 mA
Amplifiers	additional 28 A per 1 x D500 Amplifier Module (500 W power configuration) (module delivering 100 V 1 kHz sinewave into rated resistive loads)

¹ The INTEGRA is suitable for installation at altitudes equal or below 2000 m and in non-tropical environments.

² Frame Controller V4.2.0.0P and PSU V7.27.0.0 or newer are required for 110 V AC operation.

³ Charging Time and Temperature Compensation: for two serially connected Power Sonic PS12750 FR, PG-12V75T FR, PG12V65 FR or PG12V80 FR batteries.

Amplification

Maximum Output Power	2000 W (230 V AC Supply Voltage) 1000 W (110 V AC Supply Voltage)
Amplifier Slots	10
Number of Zones	10 (max.)
Amplifiers	10 x working amplifiers (max.) / 2 x standby amplifiers (max.)
Amplifier Audio Input	0 dBu sensitivity balanced audio inputs
Amplifier Audio Outputs	100 / 70 / 50 V RMS outputs
Front Panel Display and Indicators	EN 54-16, ISO 7240-16 and BS 5839-8 compliant
Real Time Clock (RTC)	built-in (externally synchronisable)
Format / Colour	black wall-mount metal box with silver annotation
Dimensions (H x W x D)	980 mm x 600 mm x 235 mm
Weight	
Back box only	29.25 kg
Back box + Electronics Assembly (no interface cards and amplifiers)	39.9 kg
Back box + Electronics Assembly (10 x interface cards and amplifiers)	47.5 kg
Back box + Electronics Assembly (10 x interface cards and amplifiers) + batteries	97.5 kg
Temperature	-20°C to +55°C (storage) / -5°C to +40°C (operation)
Humidity Range / IP Rating	0% to 93% non-condensing / IP30

9.2 Router

Interfaces

Contact Inputs	6 x combined digital ¹ and analogue ² contact inputs
Contact Outputs	4 x open-drain contact outputs ³
Changeover Relays ⁴	1 x fault relay ⁵
RS232 Port	1 x port for general and legacy control purposes (115200 baud)
RS485 Port	1 x port for ASL BMB01 Remote I/O Unit (9600 baud) 4 x ports for microphones ⁶ (19200 baud) or Host Protocol (9600 baud) ⁷
Ethernet Ports	2 x 100BASE-T Ethernet (RJ45) (standard) 2 x 100BASE-T Ethernet (RJ45) + 2 x 1 GigE SFP ⁸ slots (RJ45 or MM/SM fibre) (on the Network Card) 2 x 100BASE-TX (RJ45) + 2 x 100BASE-FX (MM or SM) Ethernet (with optional Network Switch)

¹ Digital contact inputs: opto-coupled interfaces for level conversion with built-in resistor to suit voltages of +12 to +40 V. The opto-coupled interfaces provide an internal resistance to ground of approximately 100 k Ω which may cause Fire Alarm Panels connected via the voltage-reversal method to report earth leakage faults. For all applications that require a voltage-reversal interface with the Fire Alarm Panel, ASL recommend that an ASL BMB01 Remote I/O Unit is used in order to avoid the possibility of earth leakage faults being reported by the Fire Alarm Panel.

² Analogue contact inputs:
- Internal 4k7 Ω pull-up to +7 V
- Non-monitored mode: 0 to 3.3 V = contact closed / > 3.3 V = contact open
- Monitored mode: >4.9 V = fault / 1.1 V to 4.9 V = contact closed / 0.3 V to 1.1 V = contact open / <0.3 V = fault

³ Contact outputs: wiring for 4 x contact outputs via termination board. Additional 6 x contact outputs via optional BOA01/BOA02 Break Out Adaptor.
- Maximum Rated Current per output: 350 mA
- Maximum Voltage per output: 60 V

⁴ Voice Alarm: not available with standard internal wiring. Refer to ASL for alternative wiring for Voice Alarm relay.

⁵ Fault relay: NO contacts closed in normal operation, open on fault.

⁶ Microphone inputs: Inputs 1 to 4 wiring via termination board. Inputs 5 to 12 wiring via optional BOA01/BOA02 Break Out Adaptor.

⁷ Host Protocol: a Host Protocol device can be connected to one of the microphone RS485 ports.

⁸ SFP modules: refer to ASL for availability and compatibility.

DVA Messages

DVA Storage	built-in DVA storage (up to 63 messages)
Message Format.....	48 kHz 16 bit mono WAV files (10 minutes audio time)
	24 kHz 16 bit mono WAV files (20 minutes audio time)
	12 kHz 16 bit mono WAV files (40 minutes audio time)

Audio Input and Outputs

Audio Input Channels – Analogue	4 x balanced audio input ports ¹
	Monitored universal microphone or line on all inputs
	DANS on all inputs
	Hardware Bypass Emergency Microphone Interface on two ports (inputs 1 and 2)
	Phantom power on all ports (48 V)
Audio Output Channels – Analogue	10 x balanced audio outputs ²
	Dual monitored and isolated A and B audio output channels on separate connectors
Listen-in Audio Output Channels – Analogue	2 x balanced audio outputs ³
Audio over IP (requires Network Card) ⁴	ASL PMC format
	Dante™ via Audinate® Brooklyn II module ⁵ (INTEGRA-PRO only)

Audio Performance – General

Digital Audio I/O	24-bits 48 kHz
Internal and Expansion Bus.....	32 bits floating point
Gain Control.....	Input / Output / External volume control
THD Input to Output.....	< 0.01% at 1 kHz
Crosstalk	> 70 dB below full output at 1 kHz
Residual Noise.....	< -90 dBu (A)
Frequency Response (input to output)	20 Hz to 20 kHz ±0.5 dB
Ambient Noise Sensing	Programmable output level control
Night Volume Control.....	Daily time controlled

Audio Input Performance⁶

Input Sensitivity.....	-60 / -40 / -20 / 0 dBu
Input Overload	+20 dB
Maximum Input Level.....	+20 dBu
Input Trim.....	-90 dB to +10 dB (1 dB steps)
Mute	Click free
Phase Invert.....	on/off
Surveillance Tone Detection Frequency Range	20 Hz to 30 Hz / Level: -60 to 0 dB
Switchable High-Pass Filter Frequency.....	20 to 500 Hz / Slope: 12 dB/oct
4-band Parametric EQ	
Low	Frequency: 10 to 1 kHz (1 Hz steps) / Range: ±18 dB (0.1 dB steps)
	Slope: 6 dB to 12 dB/octave (shelf only) / HPF / Shelving Switch
Low-Mid	Frequency: 20 Hz to 20 kHz (1 Hz steps) / Range: ±18 dB (0.1 dB steps) / Q:1.0 to 5.0

¹ Audio inputs: Inputs 1 to 4 wiring via termination board. Inputs 5 to 12 wiring via optional BOA01/BOA02 Break Out Adaptor.

² As standard, audio outputs 1 to 10 are hardwired to amplifier slots 1 to 10. Audio outputs 1 to 12 available for connection to other devices via Audio Interface Card.

³ Listen-in: non-standard wiring required. Refer to ASL for details.

⁴ Software version V4.2.0.0 (may be subtly different on earlier or later versions):

- Up to 12 x PMC streams (6 x in + 6 x out) depending on system design and configuration.
- Up to 32 x Dante Rx channels per PAVA system.

Vipedia audio inputs (1 to 12) and outputs (1 to 4) permanently available on Dante Tx channels. Vipedia outputs 5 to 12 may be available on Dante Tx channels depending on system design and configuration.

⁵ Audinate® is a registered trademark of Audinate Pty Ltd.

Dante™ is a trademark of Audinate Pty Ltd.

⁶ Software version V4.2.0.0 (may be subtly different on earlier or later versions).

High-Mid	Frequency: 20 Hz to 20 kHz (1 Hz steps) / Range: ± 18 dB (0.1 dB steps) / Q: 1.0 to 5.0
High	Frequency: 1 kHz to 20 kHz (100 Hz steps) / Range: ± 18 dB (0.1 dB steps) Slope: 6 dB to 12 dB/octave (shelf only) / LPF / Shelving Switch
EQ Bypass Switch	on / off
Gate	
Threshold	-60 dB to +20 dB (1 dB steps)
Attack	0.1 to 200 ms (0.1 ms steps)
Release	50 ms to 3 s (1 ms steps)
Hold	25 ms to 60 s (1 ms steps)
Gate Bypass Switch	on/off
Compressor	
Ratio	1.0:1 to ∞ :1
Threshold	-60 dB to +20 dB (1 dB steps)
Attack	0.1 to 200 ms (0.1 ms steps)
Release	50 ms to 3 s (1 ms steps)
Make Up Gain	0 to +20 dB (0.1 dB steps)
Knee	0 to +12 dB (0.1 dB steps)
Peak / True RMS Mode	Switchable
Compressor Bypass Switch	on/off
Peak Limiter	
Threshold	-60 dB to +20 dB (1 dB steps)
Attack	0.1 to 200 ms (0.1 ms steps)
Hold	25 ms to 5 s (1 ms steps)
Make Up Gain	0 to +20 dB (0.1 dB steps)
Release	50 ms to 3 s (1 ms steps)
Limiter Bypass Switch	on/off
Channel Fader	-90 dB to +10 dB (1 dB steps)
Chime Generator	
Selectable Type	OFF / 1-note (660 Hz) / 2-note (660/554 Hz) / 3-note (660/554/440 Hz) / Custom
Level	-60 dB to +10 dB (1 dB steps)
Audio Output Performance¹	
Nominal Output Level	0 dBu
Maximum Output Level	+20 dBu
Output Impedance	660 Ω
Routing Switches	To select any of input audio sources to the output channel
Mixing ²	Up to 16 simultaneous input sources
Master Level	+10 to -90 dB (1 dB steps)
Night Volume Capping	Selectable level and programmable times
Output Mute	Click free
Delay	1 ms to 5000 ms (1 ms steps)
Surveillance Tone Generators	
Low Frequency	20 Hz / 30 Hz
High Frequency	20 kHz / 24 kHz
Level	-60 dB to +10 dB (1 dB steps)
Mode	Continuous / Pulsed / Off
Pulse Interval	20 s to 100 s
Pulse Width	1 s to 10 s
Pulse Offset	0 s to 99 s
Override Gain (Hardware Bypass)	-31.5 dB to 0 dB (1 dB steps)

¹ Software version V4.2.0.0 (may be subtly different on earlier or later versions).

² Mixer used for listen-in only at the time of publication of this document.

10-band Parametric Equaliser

Low (Band-1) Frequency: 20 to 1 kHz (1 Hz steps) / Range: ± 18 dB (0.1 dB steps)
Slope: 6 dB to 12 dB/octave (shelf only) / HPF / Shelving Switch

Band (2-9)..... Frequency: 20 Hz to 20 kHz (1 Hz steps) / Range: ± 18 dB (0.1 dB steps) / Q:1.0 to 5.0

High (Band-10) Frequency: 1 to 12 kHz (100 Hz steps) / Range: ± 18 dB (0.1 dB steps)
Slope: 6 dB to 12 dB/octave (shelf only) / LPF / Shelving Switch

EQ Bypass Switch on / off

Hard Clipper Fixed or dynamic hard-clip level (0 to 20 dB)

Peak Limiter

Threshold -60 dB to +20 dB (1 dB steps)

Attack 0.1 to 200 ms (0.1 ms steps)

Hold 25 ms to 5 s (1 ms steps)

Make Up Gain 0 to +20 dB (0.1 dB steps)

Release 50 ms to 3 s (1 ms steps)

Limiter Bypass Switch on/off

Ambient Noise Sensor (ANS)

Technique ASL Proprietary Sample-Hold Technique and Dynamic ANS (DANS)

Ambient Noise Sensing Gain Adjustment -40 dB to 0 dB

Number of Auxiliary Compensation Sources for DANS 4

ANS Minimum Threshold / ANS Maximum Threshold 55 dBA / 95 dBA

Bypass Switch on / off

9.3 D150 Amplifier Module

Type transformerless class D amplifiers

Output Power¹ 25 W to 150 W (down to 21 V battery supply)

Output Voltage² and Input sensitivity 100 / 70 / 50 V RMS into 150 W load for 0 dBu 1 kHz input signal

Maximum Capacitive Load 200 nF

Regulation no load to full load, < 0.5 dB

Efficiency > 80%

Quiescent Current (at 24 V supply) 16 mA

Full Power Current (worst case 21 V battery supply) 8.3 A

Frequency Response 100 Hz to 20 kHz, ± 3 dB

THD (at 100 V RMS output, full load) < 0.5%

Residual Noise better than 80 dB (A-weighted) below full output

Dimensions (H x W x D) / Weight 80 mm x 29 mm x 274 mm / 525 g

¹ Output power: configurable in 5 W steps.

² Output voltage: configurable.

9.4 D500 Amplifier Module

Type	transformerless class D amplifiers
Output Power ¹	25 W to 500 W (down to 21 V battery supply)
Output Voltage ² and Input sensitivity	100 V RMS into 500 W load 70 V RMS into 350 W load 50 V RMS into 250 W load for 0 dBu 1 kHz input signal
Maximum Capacitive Load	200 nF
Regulation	no load to full load, < 0.5 dB
Efficiency	> 80%
Quiescent Current (at 24 V supply)	16 mA
Full Power Current (worst case 21 V battery supply)	28 A
Frequency Response	100 Hz to 20 kHz, ±3 dB
THD (at 100 V RMS output, full load)	< 0.5%
Residual Noise	better than 80 dB (A-weighted) below full output
Dimensions (H x W x D) / Weight	80 mm x 29 mm x 274 mm / 525 g

9.5 LSZDC Surveillance Interface Card

Current Consumption (average, without changeover, 24 V supply)	
Normal	15 mA ³
Loop Return Mode	39 mA
Current Consumption (average, with relays operating, 24 V supply)	39 mA with one isolation relay 39 mA with standby changeover 63 mA with isolation and standby changeover
Maximum Amplifier Output Power	refer to amplifier specifications
Surveillance Tones	low frequency (20 Hz) / high frequency (20 kHz)
Speaker Line Surveillance	DC line surveillance ⁴ , loop return or impedance single (A) or dual (A&B) speaker circuits
Earth Leakage Current Fault Threshold	2 mA (configurable)
Audio Processing	gain, gate and 10-band parametric equaliser
Dimensions (H x W x D) / Weight	64 mm x 30 mm x 121 mm / 145 g

9.6 V2000-STBY Standby Interface Card

Current Consumption	0 mA
Maximum Standby Input	refer to amplifier specifications
Standby Amplifier Interface	standby audio input (up to 100 V RMS) / 0 dBu low level audio
Dimensions (H x W x D) / Weight	26 mm x 90 mm x 118 mm / 60 g

¹ Output power: configurable in 5 W steps.

² Output voltage: configurable.

³ 7.5 mA with LSZDC firmware with power saving mode enabled (refer to ASL for availability).

⁴ DC line surveillance: Up to 10 x EOL10K resistors per amplifier. If dual (A&B) speaker circuits, the EOL10K resistors must be equally split between the two speaker circuits.

9.7 Batteries

Battery Type	Power Sonic PS-12750 FR, PG-12V75T FR, PG-12V65 FR or PG-12V80 FR (VRLA)
Battery Case Flammability	UL 94-V0 ¹
Normal Capacity (at 20 hr discharge rate) ²	
PS-12750 FR	80 Ah
PG-12V75T FR	80 Ah
PG-12V65 FR	65 Ah
PG-12V80 FR	80 Ah
Required Temperature Compensation ³	-24 mV/°C
Float Charge Voltage at 25°C	27.3 V +/-1.1%
Temperature Range (operating)	-5°C to +40°C
Humidity Range	0% to 93% non-condensing
Overall Dimensions (H x W x L) / Weight:	
PS-12750 FR	207 mm x 168 mm x 260 mm / 23 kg
PG-12V75T FR	210 mm x 168 mm x 260 mm / 25 kg
PG-12V65 FR	210 mm x 168 mm x 260 mm / 21 kg
PG-12V80 FR	208 mm x 168 mm x 259 mm / 23 kg

9.8 Part Codes⁴

INTEGRA Part Codes

INTEGRA-00	No amplifiers/interface cards
INTEGRA-03	3 x D500 500 W amplifiers and interface cards ⁵
INTEGRA-05	5 x D500 500 W amplifiers and interface cards ⁵
INTEGRA-07	7 x D500 500 W amplifiers and interface cards ⁵
INTEGRA-10	10 x D500 500 W amplifiers and interface cards ⁵

INTEGRA-PRO Part Codes⁶

INTEGRA-PRO-00	No amplifiers/interface cards
INTEGRA-PRO-03	3 x D500 500 W amplifiers and interface cards ⁵
INTEGRA-PRO-05	5 x D500 500 W amplifiers and interface cards ⁵
INTEGRA-PRO-07	7 x D500 500 W amplifiers and interface cards ⁵
INTEGRA-PRO-10	10 x D500 500 W amplifiers and interface cards ⁵

Optional Item Part Codes

V2000-STBY Standby Interface Card	second standby amplifier
SFP Modules ⁷	MM (multimode fibre) module / LC duplex SM (single mode fibre) module / LC duplex RJ45 (copper) module

¹ Battery case flammability: To ensure IEC / EN 62368-1 compliance, INTEGRA batteries must be rated to UL 94-V0 flammability.

Note that any Power Sonic batteries without FR (V0) product codes are only rated to UL 94-HB flammability.

² Do not mix battery types with different Ah ratings in an INTEGRA unit.

³ Temperature compensation for two serially connected batteries.

⁴ Refer to ASL for latest product list and part codes.

⁵ One standby amplifier: one amplifier is configurable as standby amplifier without additional hardware and wiring.

Two standby amplifiers: requires additional V2000-STBY Interface Card and external wiring.

⁶ INTEGRA-PRO-XX: Units may be supplied with one of the Network Switches, mounting kit and required wiring and cable. Refer to ASL for details.

⁷ SFP modules: refer to ASL for availability and compatibility.

Network Switch

NETWORK-SWITCH-MM4.....	10/100 Mbit/s / Multimode fibre (SC duplex) + 2 x RJ45
NETWORK-SWITCH-SM4	10/100 Mbit/s / Single mode fibre (SC duplex) + 2 x RJ45
INTEGRA-SWITCH-MOUNT	Network Switch mounting kit
BMB01 Remote I/O Unit	18 - 40 V DC supply RS485 control data (9600 baud) 12 analogue inputs (internally pulled up to 5 V by 4.7 kΩ) 12 digital inputs (opto-isolated interfaces with built-in resistor to suit voltages of +12 to +40 V) 12 digital outputs (open-collector, 350 mA max, 60 V max)
INTEGRA-DIN-KIT	Expansion DIN Rail and mounting kit
BOA01	RJ45 Break Out Adaptor (single port)
BOA02	RJ45 Break Out Adaptor (four ports)
EOL10K-10PK	DC Monitoring End Of Line Resistor (pack of 10)
EOLZ01-10PK	Impedance Monitoring End Of Line Device (pack of 10)

10 Mechanical Dimensions

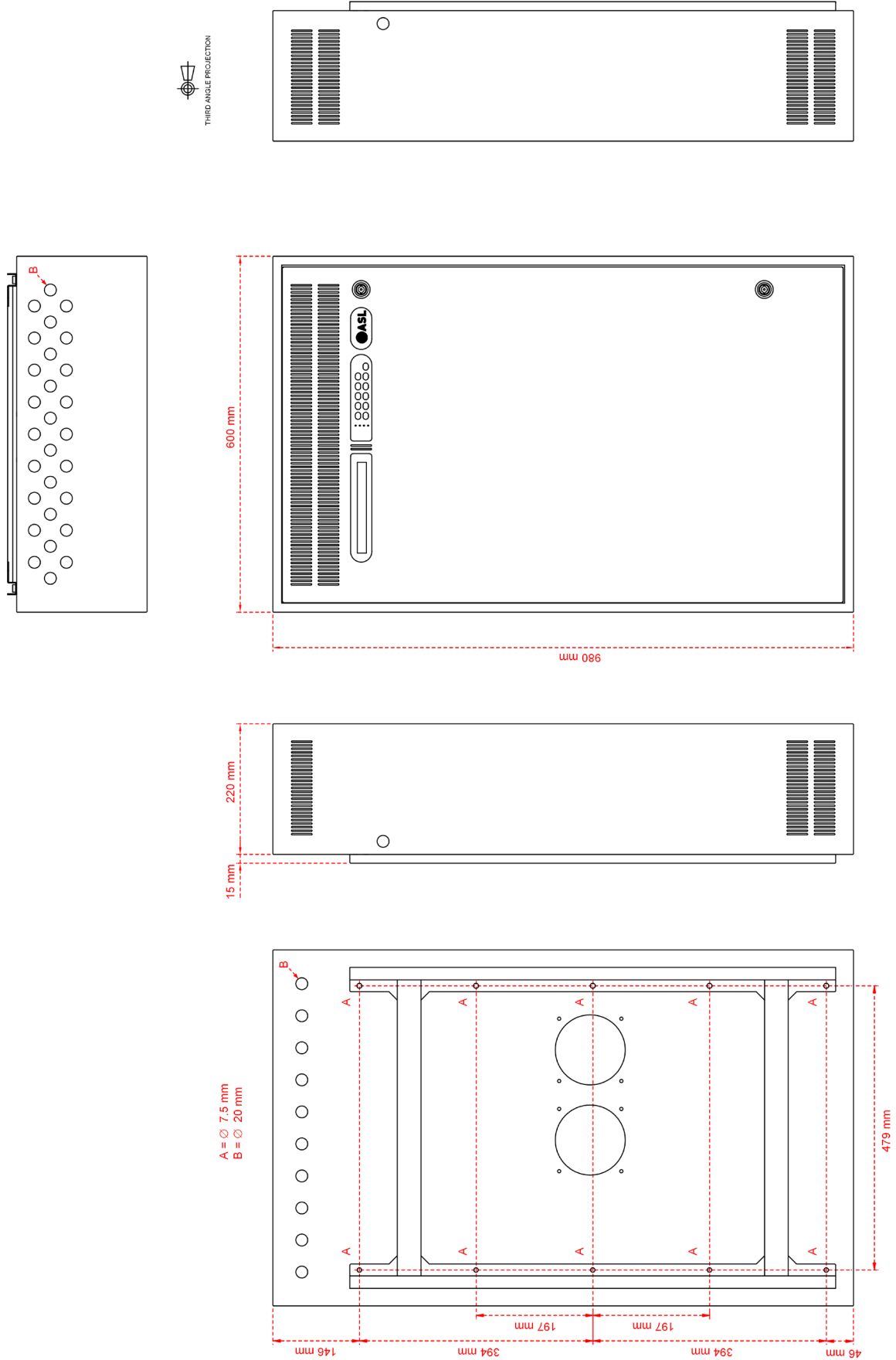

11 Storage and Preservation

This product should be packed for storage in the original packing as described in the Section “10 Packing for Return” (page 128) and stored in the following environmental conditions:

- Away from harsh environmental conditions, such as areas that are subject to corrosive atmosphere, excessive moisture or may allow water or other liquids to come into contact with the unit or its external connections.
- In a heated and humidity controlled storage area where the temperature and humidity are within the equipment specification.

12 Packing for Return



The Electronics Module, interface cards and amplifier modules contain static-sensitive devices. Observe ESD precautions when handling the interface cards, the amplifier modules or electronics module with the covers removed.

If a product is being returned for servicing, try to use the containers and materials of the original packaging. Attach a tag indicating the type of service required, return address, equipment type and full serial number.

If the original packing can no longer be used, the following general instructions should be used for repacking with commercially available materials:

- All electronic assemblies must be properly packed in ESD protective packing for transport, to prevent physical and ESD damage.
- The filler material used for packing must be antistatic or static dissipative, as this may come into contact with exposed connectors, wiring, or PCB assemblies. The use of non-conductive filler material may cause damage to the electronic assemblies reducing their operational life, or even destroying them.
- Use a sturdy cardboard box that will support the weight and size of the equipment.
- Attach a tag indicating the type of service required, return address, equipment type and full serial number.
- Completely wrap the equipment in bubble wrap (all sides must be protected) and secure the wrap in place with tape.
- Place the wrapped equipment inside the box surrounded by filler material, ensuring that there is no room for movement.
- Seal the box securely with packing tape.

This page intentionally left blank.

This page intentionally left blank.

Service and Warranty

Name and Address of Authorised Distributor:

This product carries a full warranty. For full details of warranty and service agreements, please contact the Authorised Distributor who supplied the product to you.

Exclusions

The warranty does NOT cover:

1. Customer misuse, including incorrect installation.
2. Damage other than manufacturing defects.
3. Transit / Courier damage.
4. Incorrect voltage or power supply used.
5. Incorrect input signal.
6. Abnormal environmental operating conditions.
7. Damage incurred by accident, fire, lightning or other hazard.
8. Modification to the unit or inexpert / attempted repair.
9. No fault found – where no fault can be found after extensive testing, indicating user error or failure in ancillary equipment.
10. Electronic assemblies which are improperly packed when returned for repair or service. All electronics assemblies must be properly packed in ESD protective packing for transport to prevent physical and ESD damage.

Should any of the above apply, Application Solutions (Safety and Security) Limited reserves the right to raise any relevant charges to the customer.

Application Solutions (Safety and Security) Limited shall not be liable for any indirect, special or consequential loss or damage (including without limitation any loss of profits) arising from the use of this product or for any breach of this warranty.

In the interest of continual product development, Application Solutions (Safety and Security) Limited reserves the right to make changes to product specification without notice or liability.

