



Exigo VACIE Voice Evacuation System EN 54-16

Contents

1	Introduction	6
1.1	Document Scope	6
1.2	System & Configuration Software	6
1.3	Publication Log	6
1.4	Related Documentation	6
1.5	Terminology	6
2	System Requirements & Solution	7
2.1	Regulations	7
2.1.1	EN 54-16	7
2.1.2	Mechanical & Environmental Requirements	8
2.1.3	Codes and Standards	9
2.2	System Components	9
2.3	System Configuration	10
2.4	Power Solution	12
2.5	Inputs	13
2.5.1	Supervised Inputs	14
2.6	Outputs and Indicators	15
2.6.1	System Rack	15
2.6.2	Emergency Microphone Panel	16
3	Compliance	17
3.1	Voice Alarm Manual Control	17
3.2	Emergency Microphone	17
3.3	Voice Alarm Condition Output	18
3.4	Fault Indication Related to Transmission Path to CIE	18
3.5	Fault Indication Related to Voice Alarm Zones	18
3.6	Manual Silencing of Voice Alarm Condition	18
3.7	Manual Reset of Voice Alarm Condition	19
3.8	Indication of Disablement	19
3.9	Ancillary Functions	19
3.9.1	PA Access Panels	19
3.9.2	Audio Inputs & Outputs	19
3.10	Supervision & Indication – System Controller	20
3.10.1	General	20
3.10.2	Alarm Handling	20
3.10.3	Fault Indication	21
4	Operating Procedures	22
4.1	Central Equipment	22
4.1.1	ESC1 System Controller	22
4.1.2	ENA2200 Network Amplifier	22
4.2	Panels	22
4.2.1	Voice Alarm Manual Control Panel	22
4.2.2	Emergency Microphone Panel	23
4.2.3	ECPIR-P without EBMDR-8	23

5	Installation Procedures	24
5.1	Access Levels	24
5.1.1	Main Equipment Rack	24
5.1.2	Access Panels	24
5.2	Equipment Racks & Cabinets	24
5.3	Cabling Requirements	25
5.4	Installing the ESC1 System Controller	25
5.4.1	ESC1 Overview	25
5.4.2	ESC1 Technical Specifications	27
5.4.3	Placement	28
5.4.4	Mounting	28
5.4.5	Power supply	28
5.4.6	Grounding	28
5.4.7	Installing Main Processor Board	28
5.4.8	Ethernet Connections	28
5.4.9	Fault Relay	28
5.4.10	Control Inputs	29
5.4.11	Control Outputs	29
5.5	Installing the ENA2200 Amplifier	30
5.5.1	ENA2200 Overview	30
5.5.2	ENA2200 Technical Specifications	31
5.5.3	Placement and Stacking	32
5.5.4	Mounting	32
5.5.5	Power Supply	32
5.5.6	Grounding	32
5.5.7	Ethernet Connections	32
5.5.8	Fault Relay	32
5.5.9	Control Inputs	33
5.5.10	Control Outputs	33
5.5.11	Loudspeaker Connections	33
5.6	Network Interconnections	33
5.7	Installing the ECPIR Panels	34
5.7.1	ECPIR-3P Overview	34
5.7.2	Placement	35
5.7.3	Power Supply	35
5.7.4	Ethernet	35
5.7.5	Muting External Equipment	36
5.7.6	Microphone	36
5.8	Installing the EBMDR-8 Button Expansion Module	36
5.8.1	EBMDR-8 Overview	36
5.8.2	Placement	37
5.8.3	Connection	37
5.9	Installing the EAPII Access Panels	38
5.9.1	EAPII Overview	38
5.9.2	Placement	39
5.9.3	Power Supply	39
5.9.4	Ethernet	39
5.9.5	Muting External Equipment	39
5.9.6	Microphone	39
6	EN 54-16 Programming & Wiring	40
6.1	Configuration Reference List	40
6.1.1	Central Equipment	40
6.1.2	Access Panels	40
6.1.3	Zones	40

6.1.4	Amplifier Channels	41
6.1.5	Line End Transponder Configuration	41
6.2	System Parameters	41
6.2.1	Voice Evacuation Messages	41
6.2.2	Access Control	42
6.3	Control Inputs & Outputs	42
6.3.1	Control Outputs	42
6.3.2	Control Inputs	42
6.4	Access Panel Buttons	43
6.4.1	Access Panel CP-1	43
6.4.2	Access Panel Control Outputs	43
7	Maintenance.....	44
7.1	Fuse Ratings	44
7.2	Factory Reset on ESC1 System Controller	44
7.2.1	Resetting Primary System Controller	44
7.2.2	Resetting Secondary System Controller	45
7.2.2.1	Resetting from Web Interface	45
7.2.2.2	Resetting from GUI Display	45
7.3	Factory Reset on ENA Amplifier	46
7.3.1	Resetting from Web Interface.....	46
7.3.2	Resetting from GUI Display.....	46
7.4	Factory Reset on Access Panels	47
7.5	Replacing System Devices	47
7.6	Maintenance of System Controller.....	48
7.6.1	Battery Life	48
7.7	Maintenance on Speaker Loops	49
7.8	Tick Tone	49
7.9	Indicator Test	49
7.10	Software Upgrade	49
7.10.1	Prerequisites	49
7.10.2	Upgrading the Software	49
A	System Controller Menu Structure.....	51
A.1	Idle Screen	52
A.1.1	Idle Screen Examples	53
A.2	Access Control	54
A.3	System Controller Menu Options	54
A.4	System Fault & Warning	56
A.4.1	System Fault List.....	56
A.4.2	Reset System Fault List	57
A.4.3	System Warning List	58
A.5	Service	58

A.5.1	Local Message List	58
A.5.2	Headphone.....	59
A.5.3	Audio Output State.....	59
A.5.4	Restart & Restore.....	60
A.6	Settings	60
A.6.1	General	60
A.6.2	Audio Output Volume	61
A.6.3	Audio Input Gain	61
A.6.4	Display	62
A.7	Information	62
A.7.1	Device Info	62
A.7.2	Network.....	63
A.7.3	Attached Devices	63
A.7.4	Control Input.....	64
A.7.5	Control Output.....	64
A.7.6	Diagnostic	65
B	Amplifier Menu Structure.....	66
B.1	Idle Screen	66
B.2	Access Control.....	68
B.3	Amplifier Menu Options.....	68
B.4	Service	69
B.4.1	Local Message List	69
B.4.2	Headphone.....	70
B.4.3	Tick Tone	70
B.4.4	Audio Output State.....	71
B.4.5	Restart & Restore.....	71
B.5	Settings	72
B.5.1	General	72
B.5.2	Audio Output Monitoring	72
B.5.3	Audio Output Volume	74
B.5.4	Audio Input Gain	75
B.5.5	Display	75
B.6	Information	76
B.6.1	Device Info	76
B.6.2	Network.....	76
B.6.3	Attached Devices	77
B.6.4	Control Input.....	77
B.6.5	Control Output.....	78
B.6.6	Diagnostic	79
C	Marking & Labeling	80
D	Specifications	81

1 Introduction

1.1 Document Scope

This document describes the configuration of the Exigo PA/GA system in an EN 54-16:2008 certified system and provides information about each of the components in the system and overall system design, operation and characteristics. This document is aimed at system administrators & installers.

1.2 System & Configuration Software

Exigo Software Package version: EXIGO-1.4.3 or later

Exigo Device Software VSF-Turbine (vsft) version: 4.10.3.x or later

1.3 Publication Log

Revision	Date	Author	Status/Comments
1.2	21.7.2016	HKL	Updated, Proofread and Published
1.3	11.7.2017	HKL	EN 54 marking, battery, factory reset
1.4	20.3.2018	HKL	UL safety standards for ENA2200
1.5	20.7.2018	HKL	Loudspeaker connections diagram
1.6	24.1.2019	HKL	EN 54 label change
1.7	13.8.2020	HKL	EN 54 label change, EMMAR-1H mic removed

1.4 Related Documentation

Doc. no.	Documentation
A100K11460	Exigo Technical Manual
A100K11471	Exigo User Manual
A100K11607	Replacing Access Panel ECPIR
A100K11579	Exigo Access Panel EAPII Mounting Manual
	Replacement Manuals for ESC1 and ENA2200
	Exigo Wiki articles on https://exigo.zenitel.com

1.5 Terminology

Acronyms

Acronym	Description
PA	Public Address
CIE	Control and Indicating Equipment
VACIE	Voice Alarm Control and Indicating Equipment

Definitions

Term	Definition
Voice Alarm Manual Control Panel	Device used for interaction between operator and Voice Alarm system. Used to start pre-recorded alarm message.
Emergency Microphone Panel	Device used for interaction between operator and Voice Alarm system. Used to make live announcements.
Central Equipment	Equipment located centrally in the system, e.g. system controllers and amplifiers.
Field Equipment	Equipment located in the field, e.g. loudspeakers, access panels and signal lights.

2 System Requirements & Solution

2.1 Regulations

2.1.1 EN 54-16

EN 54 Part 16 specifies requirements, methods of test, and performance criteria for Voice Alarm Control and Indicating Equipment (VACIE) for use in fire detection and fire alarm systems installed in buildings, where the alarm signal is in the form of tones or voice messages, or both. The drawing in Figure 1 is a replica of Figure D.2 in the standard and reflects the Exigo system when used as a fire alarm voice alarm system.

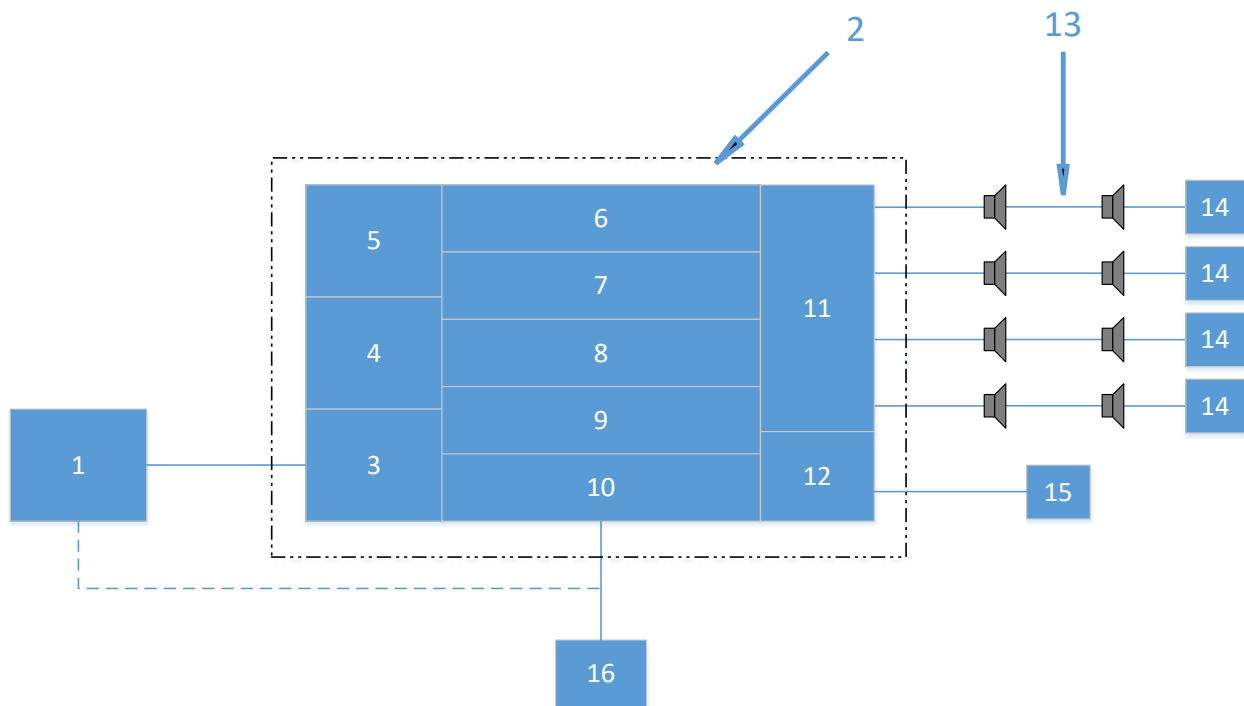

Figure 1: Schematic Diagram of a Fire Alarm Voice Alarm System

Key

1: CIE (EN 54-2)	9: Message Generation
2: VACIE	10: Amplification
3: Fire Alarm Interface	11: Voice Alarm Zone Outputs
4: Emergency Microphone(s) & Control	12: Fire Alarm Device Outputs
5: Operational Microphone(s) & Control	13: Voice Alarm Zones
6: Indicators	14: End-Of-Line Device
7: Manual Controls	15: Fire Alarm Devices
8: Processing, Prioritizing & Signal Routing	16: Power Supply Equipment

Figure 2 correlates the different components that make up an Exigo system to the system configuration as defined in Figure 1. Line-end devices are not required for EN 54-16 compliance provided that the system has other means to detect faults on the speaker lines. The certified amplifier ENA2200 is capable of detecting faults by measuring the impedance of the speaker line. It is, however, advisable to add the ELTSl-1 line-end transponders when there are multiple speaker line branches connected to the same amplifier output as this makes it possible to detect faults on specific branches (see *A100K11460 Exigo Technical Manual*).

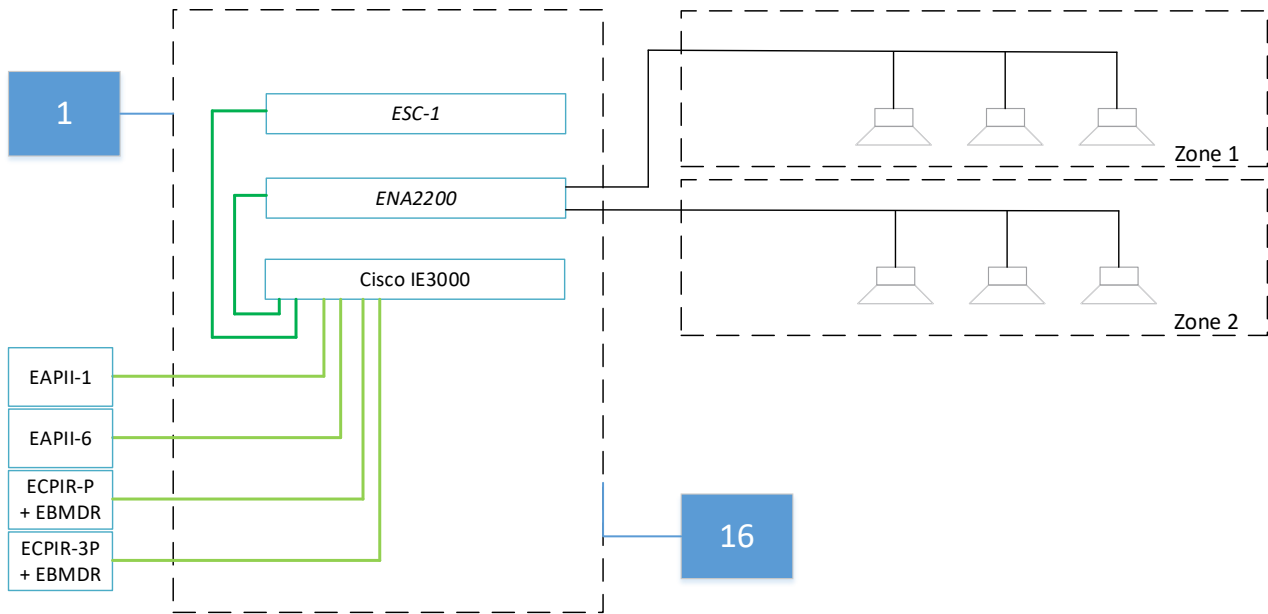

Figure 2: Exigo System Setup Correlated with EN 54-16

The system as described reflects the capabilities of Exigo. The Exigo system as installed at a customer site can be larger but will always be built with the same components as described in this manual. Note also that non-Vingtor-Stentofon equipment is required in addition to provide the power and network infrastructure. This 3rd-party equipment must comply with the strict requirements as specified in this document.

The 3rd-party equipment which was used for the EN 54-16 certification of the Exigo system does comply with these requirements and has a Vingtor-Stentofon preferred equipment status.

2.1.2 Mechanical & Environmental Requirements

All Exigo components that make up the VACIE must be installed in cabinets that offer protection up to at least an Ingress Protection rating of IP30.

All Exigo components are guaranteed to operate at the following environmental conditions as measured outside the cabinet in which the components are mounted:

- Class 3k5 of EN 60721-3-3:1995 as amended by EN 60721-3-3:1995/A2:1997

Please refer to the datasheet of each specific item for its operational temperature range. The minimum environmental conditions in which all Exigo components are designed to operate are:

- Temperature range: -10°C to +55°C
- Relative Humidity: <95% at 55°C

To fulfill the following safety standards, the ambient temperature of the ENA2200 must not exceed 45°C:

- EN 60065:2002 + A1:2006 + A11:2008 + A2:2010 + A12:2011
- EN 60065:2014
- IEC 60065:2001(Seventh Edition) + A1:2005 + A2:2010
- IEC 60065:2014 (Eight Edition)
- UL 60065 Edition 7 - Revision Date 2013-07-24
- UL 60065 Edition 8 - Issue Date 2015-09-30

Storage temperature of all items:

- Temperature range: -40°C to +70°C

2.1.3 Codes and Standards

The Exigo VACIE is tested and certified in accordance with:

- **EN 54-16:2008** 'Fire detection and fire alarm systems – Part 16: Voice alarm control and indicating equipment'

2.2 System Components

The products from the Exigo range which can be part of an EN 54-16 compliant system are:

Item Number	Item Name	Description
1023000000	ESC1	System Controller
1023102200	ENA2200	Network Amplifier
1023200030	ECPIR-P	Access Panel, PTT Button, Pluggable Mic
1023200033	ECPIR-3P	Access Panel, PTT + 3 Buttons, Pluggable Mic
1023253008	EBMDR-8	Button Expansion Module, 8 Buttons
1023201201	EAPII-1	Industrial Access Panel, 1 Button
1023201206	EAPII-6	Industrial Access Panel, 6 Buttons
1023533312	EMMAI-2H	Handheld Industrial Microphone, Compact (for EAPII)
3005020033	MB-30G	Gooseneck Microphone F/ETB, CTB, SPA

Table 1: Exigo EN 54-16 Compliant Items



The supplementary products as listed in Table 2 are required to provide a complete voice evacuation system.

Item	Comment
Network Switch	Cisco IE-3000-8TC in combination with IEM-3000-4PC
Power solution, charger	The selected power solution must be 54-4 certified, for instance Bosch PRS-48CH12 battery charger
Power solution, batteries	The selected batteries must at least provide backup capacity as required by local regulations
Rack	The racks must provide ingress protection to at least classification IP30
Speakers	Speakers must be EN 54-24 certified
Protective Devices	All field connections must be protected against surges on mains and I/O

Table 2: Additionally Required Items

2.3 System Configuration

A VACIE has to support some minimum requirements. These requirements influence the way in which the Exigo system has to be configured for:

- Power Supplies
- External Indicators
- Rack Assembly
- System Size and Distribution

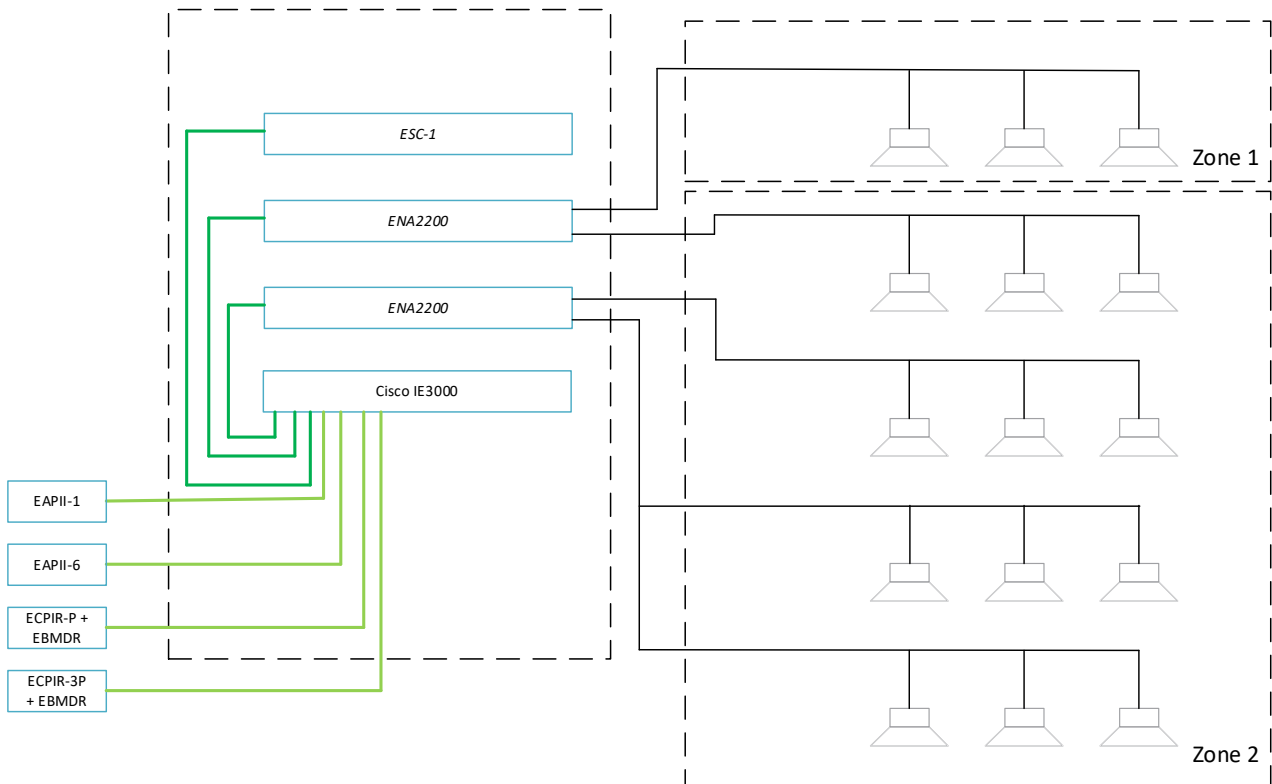

Figure 3: VACIE System Configuration

The system rack in Figure 3 depicts a system with one system controller and two amplifiers within a single rack.

In large distributed systems, there is a single place where all mandatory manual controls and indicators are located – i.e. the rack in which the ESC1 System Controller is mounted.

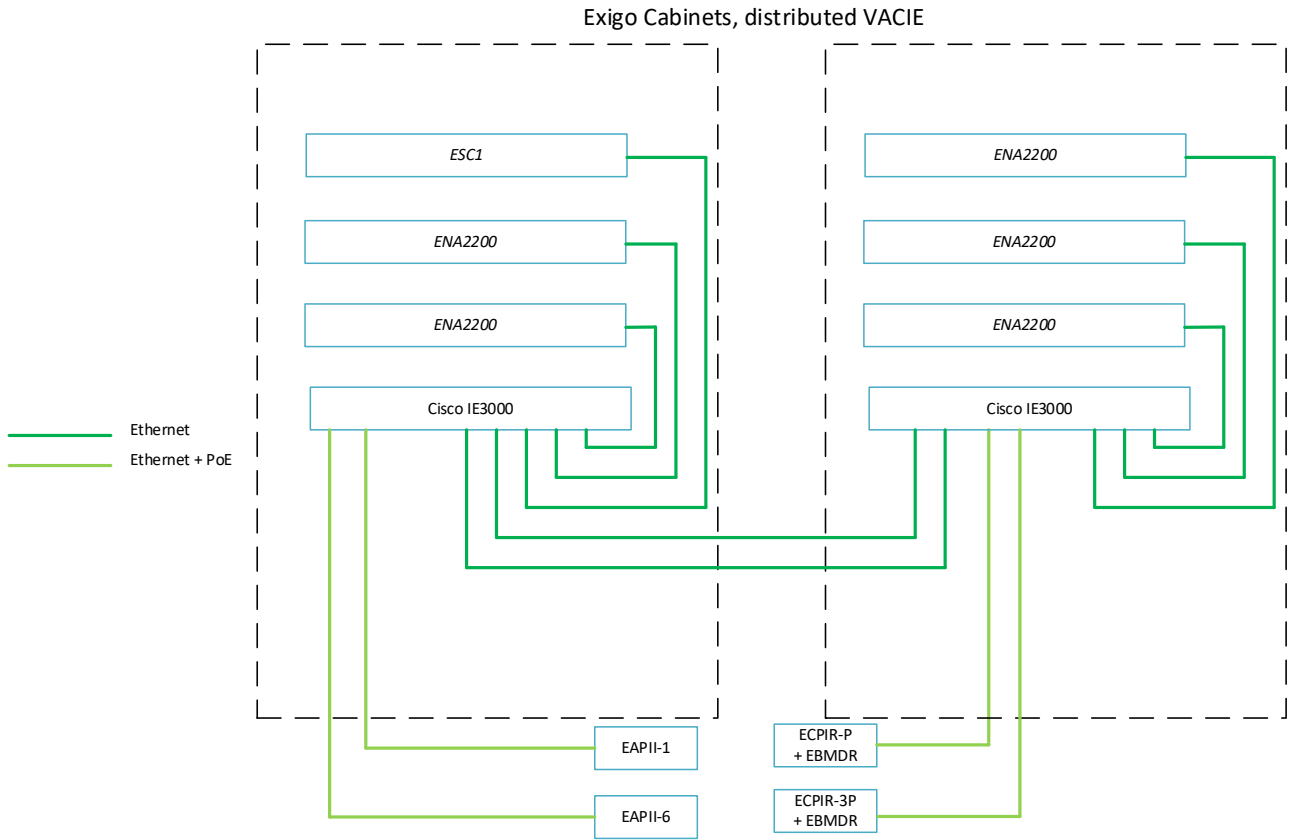

Figure 4: Distributed VACIE System Configuration

2.4 Power Solution

The power solution as shown in Figure 5 provides the required level of power supply redundancy and backup for the VACIE.

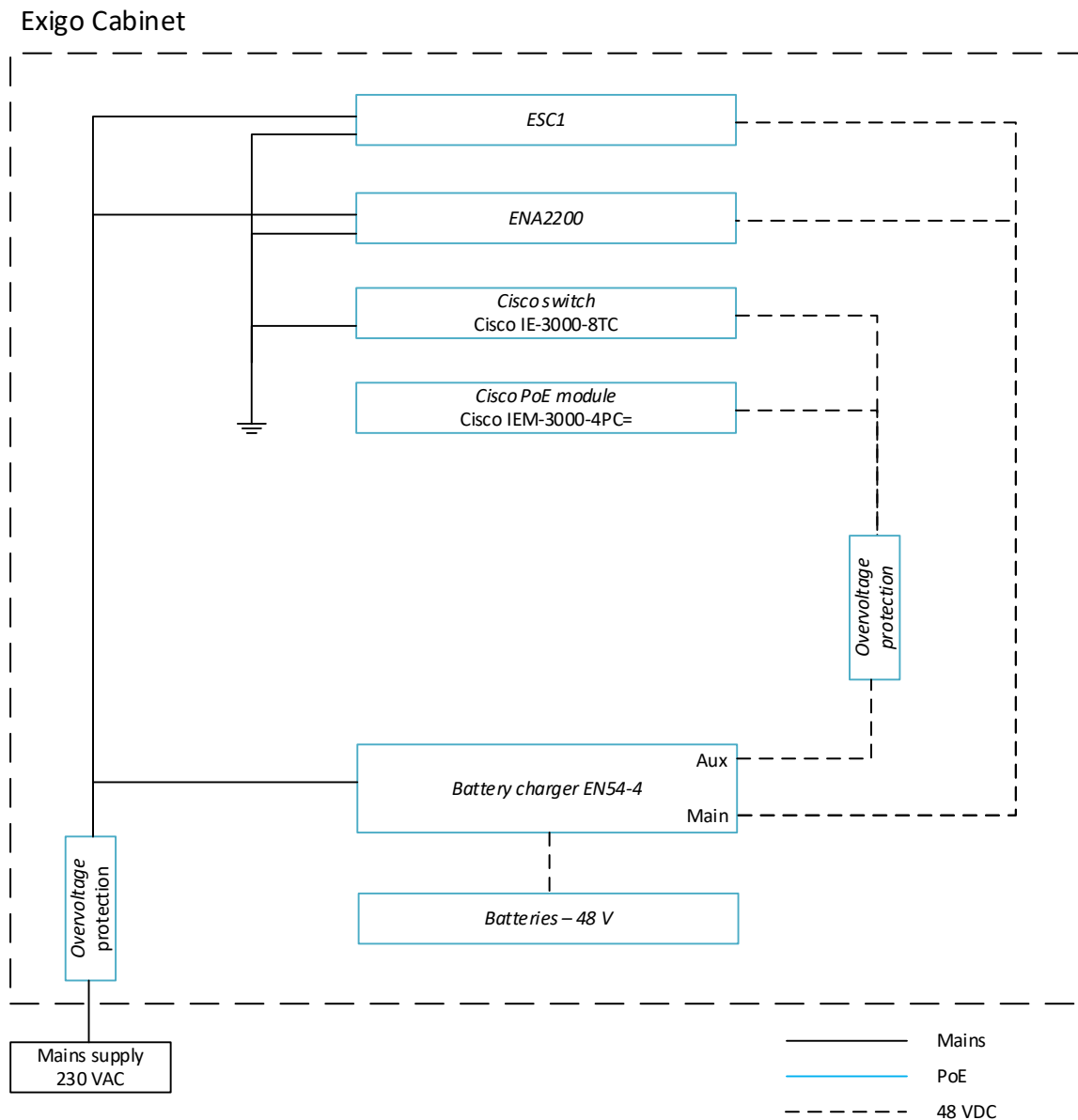

Figure 5: VACIE Power Arrangement

The ESC1 System Controller and ENA2200 Network Amplifier are powered from the mains and have a 48V DC battery backup supply. The Cisco network switch, which is required to provide a voice transmission path, is powered from an auxiliary output on the 48V DC battery backup supply.

The mains power input must be protected against electrical surges with a suitable protection device.

The selected battery charger must have the following characteristics:

- EN 54-4 approved
- Enough main outputs to wire individually to system controller and amplifier(s)
- Auxiliary outputs to power the network switch
- Fault relays

An example of an approved battery charger is the Bosch PRS-48CH12 which has 6 main outputs - enough for 1 system controller, 5 amplifiers, and 3 auxiliary outputs. If more amplifiers are present in the system, or more backup power is required than the above described system can deliver, more chargers and batteries may be required.

DC backup power is supplied by batteries. It is the responsibility of the installer to provide enough backup power capacity to satisfy the requirements of EN 54-16 and local regulations related to backup time. The necessary number of amplifiers in the system has a major impact on this requirement. The batteries are charged, and kept at the charged level, by an EN 54-4 approved battery charger.

Item Name	Power Consumption
ESC1	$P_{Nom} \leq 25W$ $P_{Max} = 50W$
ENA2200	$P_{Idle} \leq 25W$ $P_{Max} = 250W$; Voice Evacuation $P_{Max} = 500W$; Alarm tones at maximum power
ECPIR-P	$P_{Max} = 15.4W$; If powered by PoE, take into account when dimensioning power for the switch
ECPIR-3P	$P_{Max} = 15.4W$; If powered by PoE, take into account when dimensioning power for the switch
EBMDR-8	Powered directly from the ECPIR-3P or ECPIR-P panel
EAPII-1	$P_{Max} = 15.4W$; If powered by PoE, take into account when dimensioning power for the switch
EAPII-6	$P_{Max} = 15.4W$; If powered by PoE, take into account when dimensioning power for the switch

Table 3: Maximum Power Consumption - VACIE

Supplementary items must also be powered by the backup power solution.

Cisco IE-3000-8TC	$P = 24 W$
Cisco IEM-3000-4PC	$P = 8 W$ Each port that supplies PoE: $P_{PoE} = 16 W$

Table 4: Maximum Power Consumption – Supplementary Items

2.5 Inputs

Each ESC1 System Controller and ENA2200 Network Amplifier has 6 supervised inputs. All these inputs can logically be assigned to the ESC1, which expands the input capacity of the system with each amplifier that is added. Inputs are given the required functionality through configuration of the ESC1 System Controller.

The following connections are made to the inputs:

- Connection from CIE to VACIE: Alarm Silence
 - Use input 1 of the ESC1 System Controller for the Silence output from the CIE
- Connection from CIE to VACIE: Alarm Reset
 - Use input 2 of the ESC1 System Controller for the Reset output from the CIE
- Connections from CIE to VACIE: Alarm Start, one input for each alarm zone or group of zones
 - Use input 3 and higher of the ESC1 System Controller for starting alarm messages in individual zones or groups of zones
 - If it is required to use more than 4 inputs for zone selection, then use logical inputs on the ENA2200 amplifier
 - Input connections from the cabinet to the field must be protected against electrical surges, e.g. with the use of gas discharge devices.

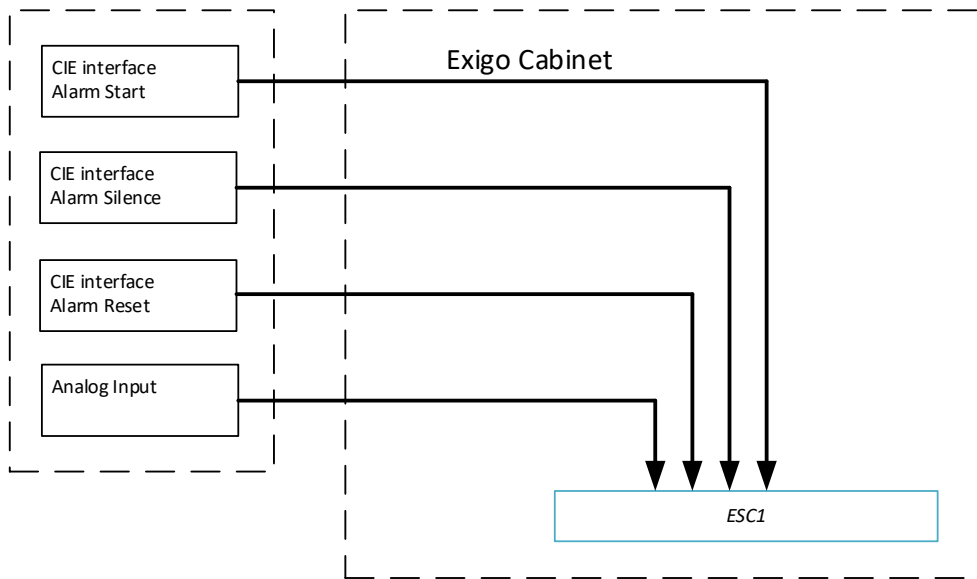

For all inputs to be supervised, use resistor network at the far end.

Figure 6: VACIE – Input Connections

2.5.1 Supervised Inputs

The control inputs on the central equipment shall be connected as monitored inputs for detection of shorts or breaks in the cable between input and output of the external equipment. Two resistors must be connected as close as possible to the external switch/relay, as depicted in Figure 7. The resistor connected in series with the external switch/relay shall have a value of 1 k Ω , while the resistor connected in parallel shall be 2.2 k Ω . As input signal, only a clean relay contact can be used.

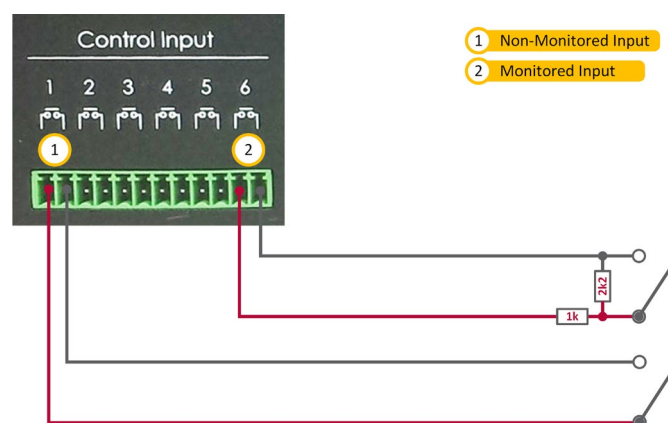
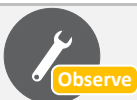

Figure 7: Control Input Connections



Monitoring of control inputs must be enabled from the Exigo Management Tool (EMT). For more information on EMT, see A100K11460 Exigo Technical Manual.

2.6 Outputs and Indicators

2.6.1 System Rack

Each ESC1 System Controller and ENA2200 Network Amplifier has 6 outputs. All these outputs can be logically assigned to the ESC1, which expands the output capacity of the system with each amplifier that is added. Outputs provide clean relay contacts, which are available both as Normally Open and Normally Closed contacts.

In addition, the ESC1 features a Fault Relay Output.

A number of indicators and outputs are required for an Exigo Voice Evacuation system to get a quick overview of the status of the system. Some indicators are visible directly on the equipment in the main equipment rack, while some are wired from the controller outputs in the rack to an indicator panel. It is up to the installer to provide a customized indicator panel which shows the necessary statuses. Outputs are given the required functionality through configuration of the ESC1 System Controller.

Output connections from the cabinet to the field must be protected against electrical surges, e.g. with the use of relay modules.

Required output connection:

- Voice Alarm Condition

Optional output connection:

- Disablement Condition output

The ESC1 fault relay output connection:

- Connection from VACIE to CIE: General Fault Output

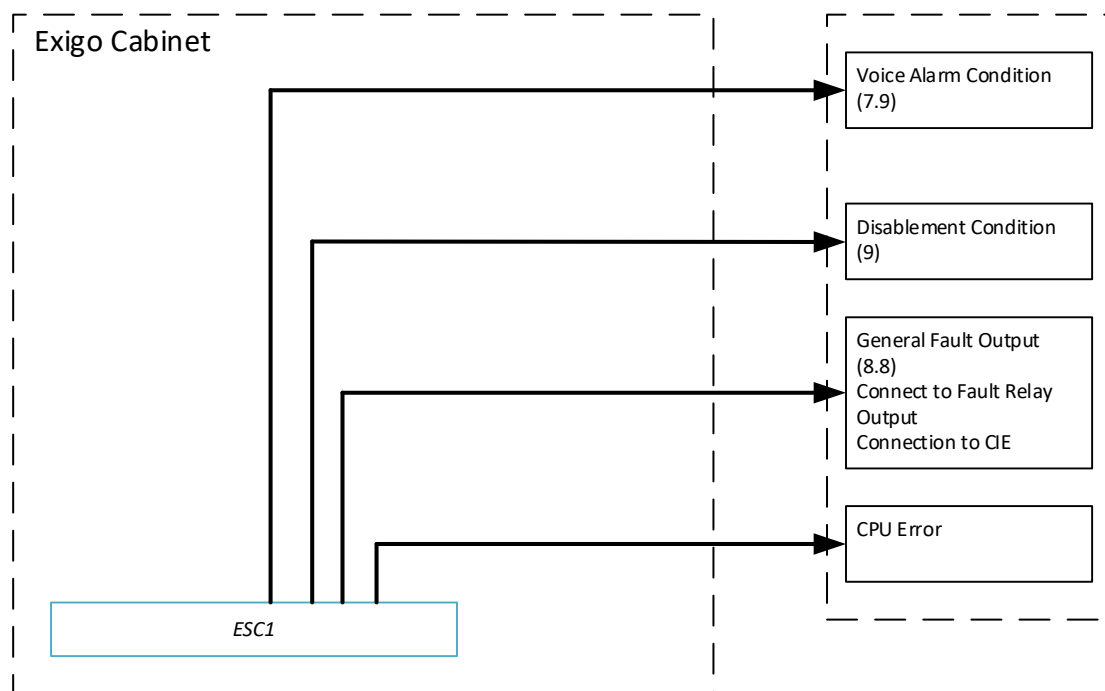

Figure 8: VACIE – Output Connections

2.6.2 Emergency Microphone Panel

Each Emergency Microphone Panel is equipped with a relay output. This output can be configured to be activated when the PTT button is pressed. The relay output can be used to mute any audible indicators, alarm bells or alarm sounders in the vicinity of the Emergency Microphone Panel.

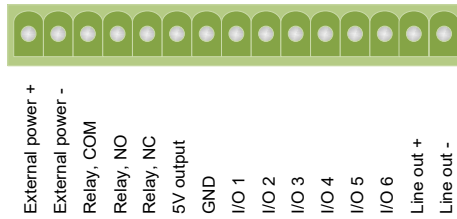

Figure 9: Relay Output for Muting Bells or Sounders

3 Compliance

Exigo supports all the mandatory requirements of EN 54-16. In addition, the following options are supported:

- Manual Reset of the Voice Alarm Condition
- Manual Silencing of the Voice Alarm Condition
- Voice Alarm Condition Output
- Indication of Faults Related to Voice Alarm Zones
- Disablement Condition
- Voice Alarm Manual Control
- Emergency Microphones

3.1 Voice Alarm Manual Control

It is possible to connect multiple Voice Alarm Manual Control panels to the Exigo system.

The Voice Alarm Manual Control Panel must be installed such that it is protected against use by the general public, but is still easily accessible for designated people to use during an emergency. A good practice is to house the panel in a lockable cabinet with a transparent front door that provides a minimum protection rating of IP30. Refer to section 5.1 for a description of access levels.

Any panel fault is reported to the ESC1 System Controller.

The ESC1 monitors the voice transmission path to the panel.

The following Exigo panels are approved for use as Voice Alarm Manual Control panels:

- ECPIR-P
- ECPIR-3P
- EAPII-1
- EAPII-6

The EBMDR-8 is an expansion module for the ECPIR-P and ECPIR-3P base modules. It has 8 selection buttons, including associated LEDs and label place holders. A maximum of 4 additional EBMDR-8 modules can be added to a base module.

3.2 Emergency Microphone

It is possible to connect multiple emergency microphones to the Exigo system. Through system setup, a different priority level can be given to each microphone. Only one emergency microphone will be active at any one time. An emergency microphone has priority over any input, including pre-recorded messages.

The Emergency Microphone Panel must be installed such that it is protected against use by the general public, but is still easily accessible for designated people to use during an emergency. A good practice is to house the panel in a lockable cabinet with a transparent front door that provides a minimum ingress protection rating of IP30. Refer to section 5.1 for a description of access levels.

The panel supervises the voice transmission path including the microphone capsule. Any panel fault is reported to the ESC1 System Controller.

The ESC1 monitors the voice transmission path to the panel.

The following Exigo panels are approved for use as Emergency Microphone panels:

- ECPIR-P
- ECPIR-3P
- EAPII-1
- EAPII-6

The EBMDR-8 is an expansion module for the ECPIR-P and ECPIR-3 base modules. It has 8 selection buttons, including associated LEDs and label place holders. A maximum of 4 additional EBMDR-8 modules can be added to a base module.

3.3 Voice Alarm Condition Output

One output on the ESC1 System Controller can be set up as the Voice Alarm Condition Output. This output will only be active when the system is in the voice alarm condition.

3.4 Fault Indication Related to Transmission Path to CIE

All outputs from the CIE to inputs on the VACIE are monitored at the VACIE. The VACIE input signals are used to:

- Start a voice evacuation message in the selected zone (one input per zone selection)
- Silence the voice evacuation message to all zones
- Reset the voice evacuation message to all zones

Failure of the transmission path between CIE and Exigo will not result in loss of control or change of state of Exigo. All inputs that are connected to CIE outputs are supervised. Exigo can determine the differences between:

- Input activation
- Input de-activation
- Broken link between input and CIE output
- Short circuit on the link between input and CIE output

A break or short circuit on any of these connections is indicated by the ESC1 system controller on the LCD screen.

3.5 Fault Indication Related to Voice Alarm Zones

All amplifiers and loudspeaker loops are supervised. Any fault that occurs and affects any zone will be indicated on the ESC1 System Controller LCD screen.

3.6 Manual Silencing of Voice Alarm Condition

It is possible to assign the manual silencing function to one of the buttons on a Voice Alarm Manual Control Panel. This button has a toggle function, such that it is possible to silence and reactivate the voice alarm. The VACIE will remain in the voice alarm state when the voice alarm has been silenced.

3.7 Manual Reset of Voice Alarm Condition

It is possible to assign the manual reset function to one of the buttons on a Voice Alarm Manual Control Panel. The operation of this button will reset the voice alarm condition. The VACIE will respond to a new voice alarm activation from the CIE or a manual control within 20 seconds.

3.8 Indication of Disablement

Zones can be disabled from the ESC1 System Controller. Each zone that is disabled will be indicated in several ways:

- General disablement condition output from the VACIE
- Indication of the disabled zone on the ESC1 System Controller

3.9 Ancillary Functions

In addition to its functionality as a Voice Alarm system, Exigo has also been designed to be used as a general purpose Public Address and background music distribution system. This ancillary functionality does not in any way interfere with its primary function of a voice evacuation system.

Voice Alarms always have priority over any other PA, messaging or background music functionality. Ongoing PA announcements will be cancelled, and the background music will be muted when any voice alarm function is started.

This section only provides basic information related to ancillary functions. For the installation and operation of ancillary functions, please refer to the specific manuals.

3.9.1 PA Access Panels

For general-purpose public address, the following panels are available:

- ECPIR-P – all zone PA announcements
- ECPIR-P with up to 4x EBMDR-8 – PA announcements or pre-selected voice messages to individual or grouped zones, maximum 32 selection possibilities
- ECPIR-3P with up to 4x EBMDR-8 – PA announcements or pre-selected voice messages to individual or grouped zones, maximum 35 selection possibilities
- EAPII-1 – all zone PA announcements
- EAPII-6 – PA announcements or pre-selected voice messages to individual or grouped zones, maximum 6 selection possibilities

ECPIR-3P, EAPII-1 and EAPII-6 panels that are set up to provide Emergency Microphone and/or Voice Alarm Manual Control functionality shall not be configured for general PA use.

3.9.2 Audio Inputs & Outputs

Exigo provides numerous input possibilities for external audio sources that can be used for messaging or background music.

Exigo provides numerous audio outputs for linking the system to 3rd-party audio broadcast equipment.

3.10 Supervision & Indication – System Controller

3.10.1 General

Exigo is capable of being simultaneously in any combination of the following functional conditions on different voice alarm zones and of indicating them with clear distinction:

- Quiescent Condition
- Voice Alarm Condition
- Fault Warning Condition

The indicators on the ESC1 System Controller consists of:

- Power Indicator
- Fault Indicator
- Voice Alarm Indicator
- LCD Screen

The power indicator consists of two green LEDs located on the system controller's front panel, one labeled **POWER AC** and the other, **POWER DC**. The LEDs will be lit when the corresponding power supply is connected and ready to source the system controller. The indicators on the ESC1 also signal the presence of power to the complete rack.

The Voice Alarm Condition is indicated on the ESC1 System Controller by means of a discrete red colored LED labeled **ALARM** that is the General Voice Alarm Activated indicator. This indication is repeated on each Voice Alarm Manual Control Panel and Emergency Microphone Panel.

The user interface consists of a graphical LCD screen and a rotary knob with push-to-select, located on the front panel of the system controller. This interface provides access to detailed information regarding general operation, alarms and faults. Exigo is able to receive alarm and fault information from different sources and clearly distinguishes between each of them.

The user interface is also equipped with a light sensor, allowing automatic adjustment of the display light and indicator intensity.

3.10.2 Alarm Handling

Exigo is capable of receiving alarm signals from a CIE and Voice Alarm Manual Control panels. Exigo will activate the appropriate voice alarm outputs within 3 seconds.

When the voice alarm condition has been triggered by the CIE, Exigo will silence the voice alarms when the CIE triggers the silence input on the ESC1 System Controller.

When the voice alarm condition has been triggered by the CIE, Exigo will reset the voice alarms when the CIE triggers the reset input on the ESC1 System Controller.

One output on the ESC1 System Controller can be set up as a Voice Alarm Condition output. This output will only be active when the system is in the voice alarm condition.

3.10.3 Fault Indication

Exigo will enter the fault warning condition when it receives error messages from the system or from inputs that are set up to report a fault condition. Exigo will enter the fault warning state as soon as a fault is detected. The maximum detection time for any error is less than 100 seconds.

The general fault indicator consists of a yellow LED labeled **FAULT** located on the front panel of the ESC1 system controller, and an audible buzzer. When a fault is detected, the system controller will activate the visual and audible fault indicators. In order to mute the audible indicator, a button (fault acknowledge) on the front of the system controller must be pressed. This will turn off the audible indicator, but not the visual indicator. The visual indicator will only be turned off when all faults are corrected and removed from the system. The audible buzzer will sound again when a new fault is registered. The visual fault indication is repeated on each Voice Alarm Manual Control Panel and Emergency Microphone Panel.

Through the system controller's user interface, faults can be selected and reset. The system will first run a check to see whether the fault is corrected. If the fault is corrected, it will be removed from the fault list. If this was the last fault in the list, the visual fault indicator will be deactivated. If the fault is still present when a reset is attempted, the system will regenerate the fault and both visual and audible indicators will be reactivated within 20 seconds.

Silencing of the audible alarm and resetting of faults require access level 2. The fault indicator can be seen at access level 1.

The ESC1 System Controller has a general fault warning output. The warning is also given when the System Controller is de-energized.

All faults in the system are listed and can easily be identified on the ESC1 System Controller LCD screen. This includes:

- A common fault indication from each battery charger in the system
- Loss of any input power due to short circuit or interruption in the power transmission path
- All earth faults are indicated as part of supervised functionality and/or supervised transmission paths
- Ruptured fuses
- An indication of a short circuit or interruption of the transmission path between parts of the Exigo system that are contained in different cabinets; transmission paths between different parts of the Exigo system consist of IP links that are all continually supervised
- Any short-circuit or circuit break to any microphone capsule in the system
- Any short-circuit, circuit break or earth fault in the voice alarm transmission path between the VACIE and loudspeakers
- Failure of any network amplifier
- All connections from outputs on the CIE to inputs in the Exigo System are supervised for breaks or short-circuits
- A system fault

A fault in any voice alarm transmission path between the Exigo VACIE and other components of the voice alarm system does not affect the correct functioning of the Exigo system itself or any other voice alarm transmission path. In order to accomplish this, any IP switch that is part of the voice alarm transmission path must support the Spanning Tree Protocol. A short, interruption or earth fault in the transmission path to a loudspeaker does not affect more than one voice alarm zone.

4 Operating Procedures

4.1 Central Equipment

4.1.1 ESC1 System Controller

For the full overview of the ESC1 System Controller menus and operation, please refer to *Appendix A*.

4.1.2 ENA2200 Network Amplifier

For the full overview of the ENA2200 Network Amplifier menus and operation, please refer to *Appendix B*.

4.2 Panels

Figure 10 shows one of the access panels that can be configured as a Voice Alarm Manual Control Panel, Emergency Microphone Panel or as both at the same time. The figure shows an ECPIR-3P, but all the other panels will operate in a similar manner even though they have different faceplates.

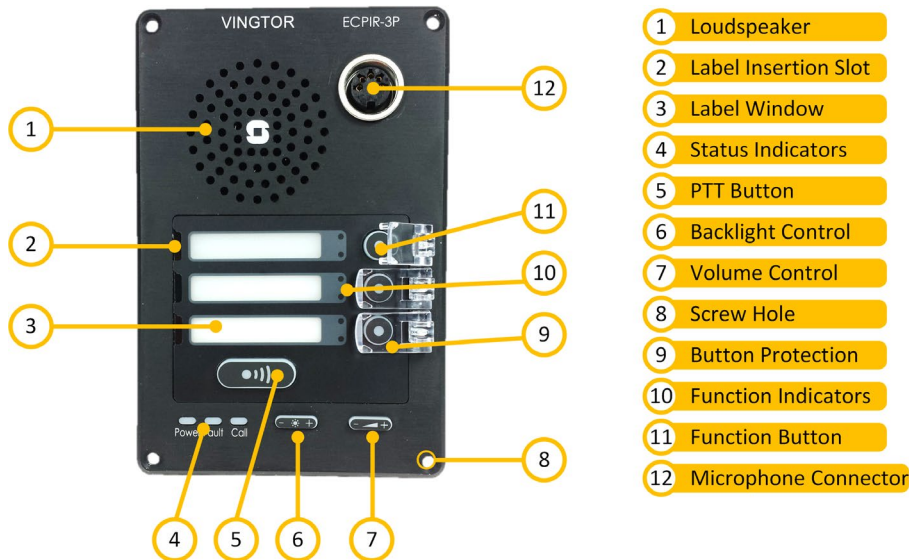

Figure 10: ECPIR-3P

4.2.1 Voice Alarm Manual Control Panel

1. Unlock and open the cabinet that houses the Voice Alarm Manual Control Panel
2. Press the 'Zone Selection' buttons for which the related red (zone in use) indicators are not lit
 - The green indicator associated to the button will be steadily lit to show that the zone has been selected on this panel
 - Press the 'Zone Selection' buttons again to deselect the zones
3. Press the button labelled 'Voice Alarm Message'
 - The green indicator associated with the button will be lit
4. The message will be repeated until the 'Voice Alarm Message' button is pressed again
5. When done, close and lock the cabinet again

4.2.2 Emergency Microphone Panel

1. Unlock and open the cabinet that houses the Emergency Microphone Panel
2. Press the 'Zone Selection' buttons for which the related red (zone in use) indicators are not lit
 - The green indicator associated to the button will be steadily lit to show that the zone has been selected on this panel
 - Press the 'Zone Selection' buttons again to deselect the zones
3. Press the PTT button on the panel (if available) or on the handheld microphone
4. Optionally a pre-announcement message or tone will be broadcast
 - During the pre-announcement the **Call** indicator on the panel will remain unlit
5. The end of the pre-announcement message will be indicated by the **Call** indicator being lit
 - Speak into the microphone while keeping the PTT button pressed
6. When done, release the PTT button and close and lock the cabinet

4.2.3 ECPIR-P without EBMDR-8

The ECPIR-P panel without the EBMDR-8 expansion module can only be used to make an announcement to all zones or a single zone. It will only operate if none of the zones that are addressed by it are in use, or if the panel has a higher priority than the activity that is currently occupying the zones.

1. Unlock and open the cabinet that houses the Emergency Microphone Panel
2. Press the PTT button on the panel (if available) or on the handheld microphone
3. Optionally a pre-announcement message or tone will be broadcast
 - During the pre-announcement the **Call** indicator on the panel will remain unlit
4. The end of the pre-announcement message will be indicated by the **Call** indicator being lit
 - Speak into the microphone while keeping the PTT button pressed
5. When done, release the PTT button and close and lock the cabinet

5 Installation Procedures

5.1 Access Levels

EN 54-16 defines 4 different access levels (please refer to *Annex A of EN 54-16 standard*). It is up to the installer of the Exigo system to make certain that these access levels can be enforced. The following information should be taken as general guidelines. Implementation is normally site-specific.

5.1.1 Main Equipment Rack

Access Level 1 gives unrestricted access to some of the main indicators. Equipment mounted in a cabinet that can be closed with a transparent door such that these main indicators are directly visible, is protected at Access Level 1.

Access Level 2 allows persons with specific operational responsibility to operate the VACIE; all Access Level 2 controls shall be located at the front of the cabinet(s). These persons must be able to open the doors of the cabinets in which the equipment is mounted by use of a key. Open spaces between equipment in the main equipment racks must be covered with blank panels to prevent access to cables.

Access Level 3 allows trained and authorized personnel to change the configuration of the system. In general, Access Level 3 requires username and password protection for accessing the system to perform such operations, or physical access requirements through the use of special keys or access control levels. Cabling inside the cabinet(s) shall be protected at Access Level 3, and shall only be accessible from the back of the cabinet(s). The locks on the back doors shall be different from the locks on the front door, thus preventing access to the cabling by persons who only have access to Level 2.

Access Level 4 allows persons to repair the VACIE, update the firmware, and in general, maintain the system. Access Level 4 normally requires at least access to Level 3 and, in addition, the use of special tools. Software updates and configuration changes require the use of usernames, passwords, PIN codes or a combination thereof.

5.1.2 Access Panels

All indicators of importance are situated in the main equipment rack and have Access Level 1 protection, see section 5.1.1.

Access Level 2 allows persons to operate the access panels. The panels must be protected by a cabinet with a lockable door.

Access panels must be mounted in the cabinets such that tools are required to access the cables, providing protection at Access Level 3.

Configuration and software updates for all panels are done from a central location and require the use of usernames, passwords, PIN codes or a combination thereof, providing protection at Access Level 4.

5.2 Equipment Racks & Cabinets

All equipment housing shall be of robust construction. It shall meet at least classification IP30 of EN60529:1992 as amended by EN60529:1991/A1:2000.

5.3 Cabling Requirements

Different types of cabling are required, both for cabling inside the racks and cabinets that house VACIE components, between racks and cabinets and to ancillary items such as CIE and speakers. The table below gives an overview of the minimum specifications for such cables.

Type	Cable requirement	Insulation	Comment
Ethernet	UTP Cat 5e	PVC	Cat 5e
Ethernet + PoE	UTP Cat 5e	PVC	Cat 5e
Mains Power	Minimum 1 mm ²	PVC	Load dependent
Speaker Loop	Minimum 0.5 mm ²	PVC	Load dependent
I/O	Minimum 0.25 mm ²	PVC	Distance dependent

Table 5: Cable Requirements

5.4 Installing the ESC1 System Controller

5.4.1 ESC1 Overview

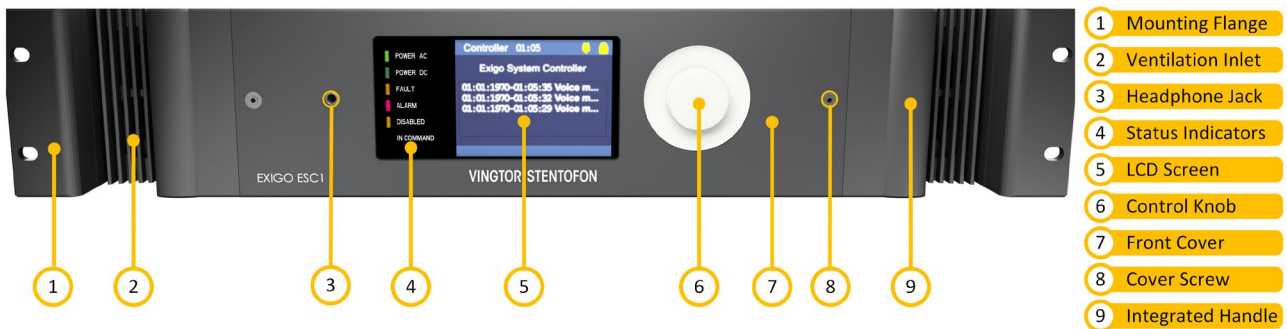

Figure 11: Front View – ESC1

- Mounting Flanges:** The mounting flanges are used to mount the unit in 19' equipment racks.
- Ventilation Inlets:** The ventilation inlets should be kept free of obstacles and dust. Fans are controlling the airflow based on internal temperature.
- Headphone Jack:** The headphone connection can be used to listen to the different audio streams in the system. See appendix A for details on the user interface.
- Status Indicators:** The status indicators are used to display the status of important parameters like power supplies and faults. See appendix A for details on the user interface.
- LCD Screen:** The LCD screen presents status and a graphical user interface. See appendix A for details on the user interface.
- Control Knob:** The control knob is used to control the user interface. The knob can be rotated and pressed. See appendix A for details on the user interface.
- Front Cover:** The front cover can be opened in order to gain access to the main processor board and the optional function board slot.

Cover Screw: The two cover screws secure the front cover in place. To open the front cover, these two screws must be loosened and pulled out 1.5 – 2 cm. The screws can then be used as handles to pull out the front.

Integrated Handles: These integrated handles make it easy to maneuver the unit, without adding to the installation depth.

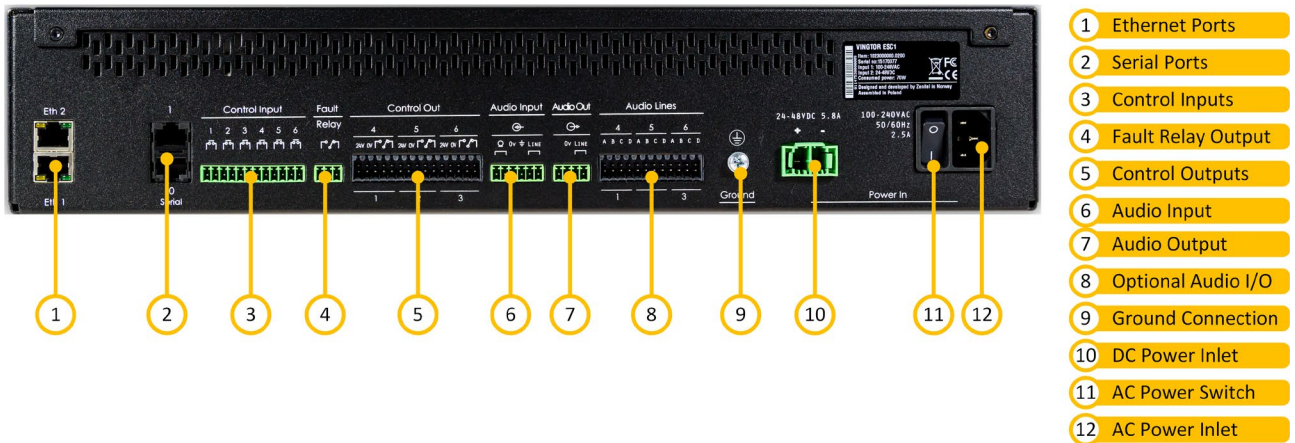

Figure 12: Rear View – ESC1

Ethernet Ports: Ethernet connections for audio and control data.

Serial Ports: RS-232 for console and RS-232/422/485 for integration with other equipment.

Control Inputs: 6 configurable control inputs. Each input is activated by closing the loop between the two terminals.

Fault Relay Output: A switching relay (NO, NC & COM) kept in the active position between COM and NO as long as no faults are present in the system.

Control Outputs: 6 configurable control outputs. A switching relay (NO, NC & COM) in parallel with a 24V_{DC} (200 mA) voltage output is available per control output.

Audio Inputs: Microphone and line-in audio inputs for microphones or external audio sources.

Optional Audio I/O: Audio inputs/outputs available in the system if the optional AGA board is inserted in the ESC1.

Ground Connection: Ground connection for grounding of the unit. This is connected in parallel with the ground connection in the AC power inlet.

DC Power Inlet: DC power inlet for 24 to 48 V_{DC}.

AC Power Switch: Power switch for the AC power. This switch will not turn off the system controller if DC backup is connected.

AC Power Inlet: AC power inlet for 110 to 230 V_{AC}.

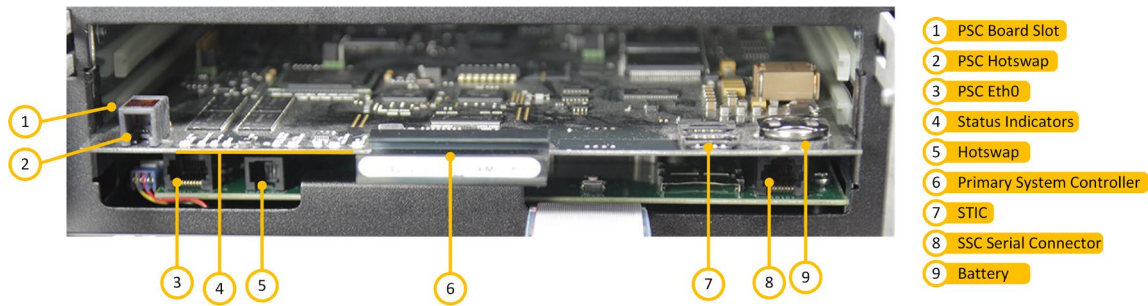

Figure 13: Internal View – ESC1

- PSC Board Slot:** Slot for the Primary System Controller board.
- Status Indicators:** Local status indicators for the Primary System Controller board.
- Primary System Controller:** Main processor board for the ESC1.
- STIC:** StenTofon Identity Card containing the ESC1’s MAC address and basic settings.
- Battery:** Battery for the time clock.

5.4.2 ESC1 Technical Specifications

<p>PRIMARY POWER</p> <p>Connector: V-lock (IEC 60320-1 C14 compliant)</p> <p>Input voltage: $V_{NOM} = 110 - 230 V_{AC}$ $V_{MIN} = 90 V_{AC}$ $V_{MAX} = 264 V_{AC}$</p> <p>Power consumption: $P_{NOM} \leq 25 W$ $P_{MAX} = 50 W$</p>	<p>SECONDARY POWER</p> <p>Connector: Pluggable and lockable screw terminal</p> <p>Input voltage: $V_{NOM} = 24 - 48 V_{DC}$ $V_{MIN} = 20 V_{DC}$ $V_{MAX} = 63 V_{DC}$</p> <p>Power consumption: $P_{STBY} \leq 2.4 W$ $P_{NOM} \leq 25 W$ $P_{MAX} = 50 W$</p>
<p>NETWORK</p> <p>Ethernet: 10BASE-TX, 100BASE-TX, Auto negotiation, Auto MDIX</p> <p>Connector: 2 x RJ45</p>	
<p>LINE INPUT</p> <p>Connector: Pluggable screw terminal</p> <p>Frequency response: 80 Hz – 20 kHz</p> <p>SNR: 80 dB</p> <p>CMRR: 45 dB</p> <p>Nominal input level: $100 mV_{RMS} - 1 V_{RMS}$</p> <p>Input impedance: $600 \Omega / 5.6 k\Omega$ software selectable</p>	<p>MICROPHONE INPUT</p> <p>Connector: Pluggable screw terminal</p> <p>Frequency response: 80 Hz – 20 kHz</p> <p>SNR: 80 dB</p> <p>CMRR: 45 dB</p> <p>Nominal input level: $1 mV_{RMS} - 100 mV_{RMS}$</p> <p>Input impedance: 600Ω</p> <p>Phantom supply: $12 V_{DC} \pm 10\% @ 15 mA$ (IEC61938, P12)</p>
<p>CONTROL INPUTS</p> <p>Connector: Pluggable screw terminal</p> <p>Type: Closing contact, monitored</p>	<p>CONTROL OUTPUTS</p> <p>Connector: Pluggable spring load terminal</p> <p>Type: Relay (COM, NO, NC) in parallel with $24 V_{DC}$ output.</p> <p>Relay outputs: Max $24 V_{DC}$, 60 W Max $250 V_{AC}$, 125 VA</p> <p>$24 V_{DC}$ outputs: $24 V_{DC}$, $\pm 10\%$, 200 mA</p>
<p>FAULT RELAY</p> <p>Connector: Pluggable screw terminal</p> <p>Type: Relay (COM, NO, NC)</p> <p>Relay outputs: Max $24 V_{DC}$, 60 W Max $250 V_{AC}$, 125 VA</p>	

Table 6: Technical Data – ESC1

5.4.3 Placement

The ESC1 can be located anywhere in the equipment rack. It is however advisable to install it at eyelevel-height as this will make it easier to operate the user interface.

5.4.4 Mounting

The ESC1's mechanical construction is rigid enough to be mounted using only the four holes in the mounting flange to secure it to the rack. It is however considered good practice to mount support rails if the system is installed in a moving environment.

5.4.5 Power supply

The ESC1 shall be connected to the equipment rack's primary and a secondary (DC) source of power.

The requirements for the power rails are listed in Table 6. The cables used for the power shall be dimensioned accordingly to voltage and current consumption of the ESC1.



Both power inputs are equipped with a lock, preventing the plug from falling out. Make sure that the plug is properly inserted, and that the lock is engaged.

5.4.6 Grounding

It is always good practice to ground the cabinet of equipment installed in racks. This ensures safety and good EMC. The grounding connection of the ESC1 should be connected to the equipment rack's ground strip using a ground wire of at least 0.75 mm².

5.4.7 Installing Main Processor Board

The main processor board must be inserted into the ESC1. Before inserting the processor board into the system controller, the SIM card containing the MAC address and basic settings must be inserted on the processor board. The small SIM card shall be mounted in the socket in the lower corner (See Figure 13) by sliding the metal retention clip back and flip the socket open. The SIM card itself shall then be inserted into this flip before the flip is replaced and the retention clip fastened.

To install the processor board, the front cover must be opened by unscrewing the two front cover retention screws. Open the front cover by pulling it out (using the two loosened screws as handles) and flipping it down. The processor board (AMC-IP) shall be inserted in the lowest position as depicted in Figure 13.



Remove all power from the ESC1 before installing or removing the processor board.

5.4.8 Ethernet Connections

The ESC1 shall be connected to the network using an Ethernet cable connected to the network switch.

5.4.9 Fault Relay

The ESC1's fault relay will trigger whenever a fault is present in the system. This relay is actively kept closed by the ESC1, so it will trigger even if the entire system controller loses power. The connection to

external equipment should be made according to the external equipment's requirements. When no faults are present in the system, an electrical connection is established between the COM and NO terminals of the fault relay. When a fault is detected, or the system controller loses power, this connection is removed and a connection between COM and NC is established.

The fault relay should be routed from the ESC1 output to a terminal block in the equipment rack.

5.4.10 Control Inputs

The control inputs should be routed from the ESC1 screw terminal to terminal blocks in the equipment rack. The number of inputs used depends on the specific system. See section 2.5 for details on using control inputs.

5.4.11 Control Outputs

The control outputs on the ESC1 should be routed to terminal blocks in accordance with the specific system's needs. See section 2.6 for details on using control outputs.

5.5 Installing the ENA2200 Amplifier

5.5.1 ENA2200 Overview

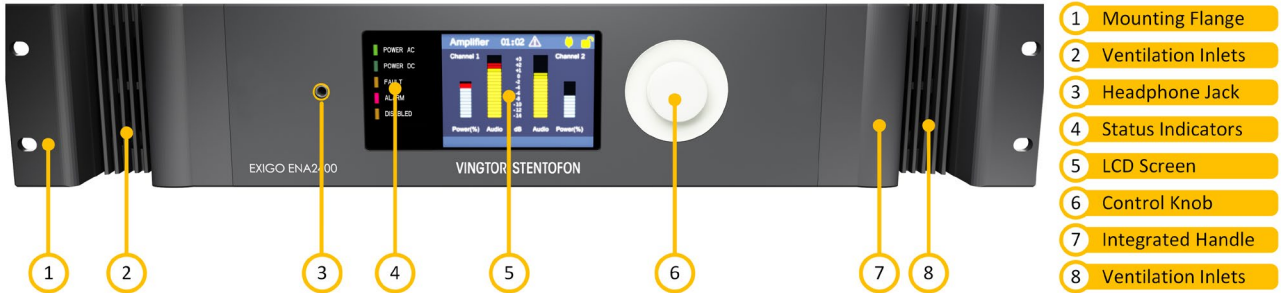

Figure 14: Front View – ENA2200

- Mounting Flanges:** The mounting flanges are used to mount the unit in 19" equipment racks.
- Ventilation Inlets:** The ventilation inlets should be kept free of obstacles and dust. Fans are controlling the airflow based on internal temperature.
- Headphone Jack:** The headphone connection can be used to listen to the different audio streams in the ENA2200. See appendix B for details on the user interface.
- Status Indicators:** The status indicators are used to display the status of important parameters like power supplies and faults. See appendix B for details on the user interface.
- LCD Screen:** The LCD screen presents status and a graphical user interface. See appendix B for details on the user interface.
- Control Knob:** The control knob is used to control the user interface. The knob can be rotated and pressed. See appendix B for details on the user interface.
- Integrated Handles:** These integrated handles make it easy to maneuver the unit, without adding to the installation depth.

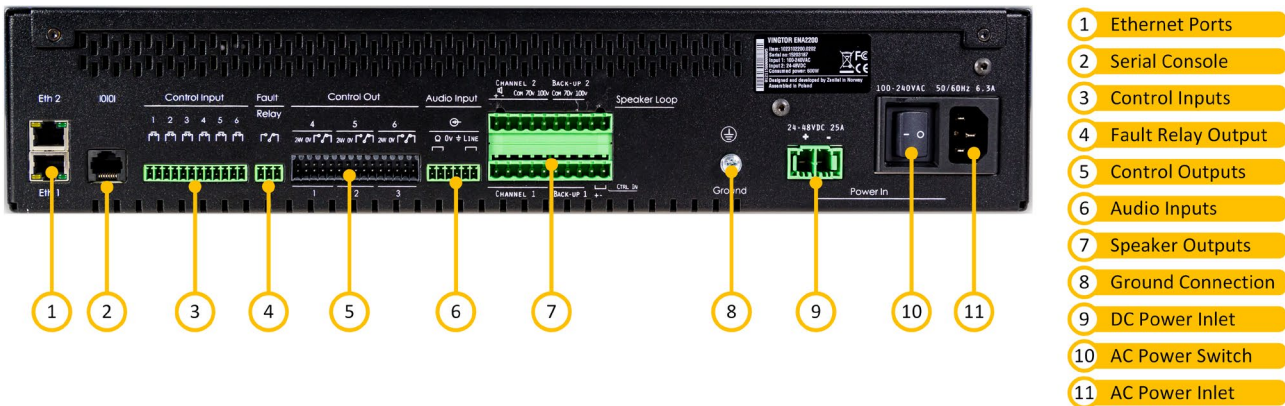

Figure 15: Rear View – ENA2200

Ethernet Ports:	Ethernet connections for audio and control data.
Serial Console:	Serial port connection for debugging and factory programming.
Control Inputs:	6 configurable control inputs. Each input is activated by closing the loop between the two terminals.
Fault Relay Output:	A switching relay (NO, NC & COM) kept in the active position between COM and NO as long as no faults are present in the ENA2200.
Control Outputs:	6 configurable control outputs. A switching relay (NO, NC & COM) in parallel with a 24V _{DC} (200 mA) voltage output is available per control output.
Audio Inputs:	Microphone and line-in audio inputs for microphones or external audio sources.
Speaker Outputs:	100 and 70 volt outputs per channel. Each channel also has a low-power 8 ohm output for single speakers. Each channel is equipped with inputs for connection to a hot-standby amplifier.
Ground Connection:	Ground connection for grounding of the unit. This is connected in parallel with the ground connection in the AC power inlet.
DC Power Inlet:	DC power inlet for 24 to 48 V _{DC} .
AC Power Switch:	Power switch for AC power. This switch will not turn off the amplifier if DC backup is connected.
AC Power Inlet:	AC power inlet for 110 to 230 V _{AC} .

5.5.2 ENA2200 Technical Specifications

PRIMARY POWER		SECONDARY POWER	
Connector:	V-lock (IEC 60320-1 C14 compliant)	Connector:	Pluggable and lockable screw terminal
Input voltage:	V _{NOM} = 110 – 230 V _{AC} V _{MIN} = 90 V _{AC} V _{MAX} = 264 V _{AC}	Input voltage:	V _{NOM} = 24 – 48 V _{DC} V _{MIN} = 20 V _{DC} V _{MAX} = 63 V _{DC}
Power consumption:	P _{IDLE} ≤ 25 W P _{MAX} = 500 W P _{PEAK} = 650 W (inrush)	Power consumption:	P _{STBY} ≤ 2.4 W P _{IDLE} ≤ 25 W P _{MAX} = 500 W P _{PEAK} = 650 W (inrush)
NETWORK		MICROPHONE INPUT	
Ethernet:	10BASE-TX, 100BASE-TX, Auto negotiation, Auto MDIX	Connector:	Pluggable screw terminal
Connector:	2 x RJ45	Frequency response:	80 Hz – 20 kHz
LINE INPUT		SNR:	80 dB
Connector:	Pluggable screw terminal	CMRR:	45 dB
Frequency response:	80 Hz – 20 kHz	Nominal input level:	1 mV _{RMS} – 100 mV _{RMS}
SNR:	80 dB	Input impedance:	600 Ω
CMRR:	45 dB	Phantom supply:	12 VDC ±10% @ 15 mA (IEC61938, P12)
Nominal input level:	100 mV _{RMS} – 1 V _{RMS}	CONTROL OUTPUTS	
Input impedance:	600 Ω / 5.6 kΩ software selectable	Connector:	Pluggable spring load terminal
CONTROL INPUTS		Type:	Relay (COM, NO, NC) in parallel with 24 V _{DC} output.
Connector:	Pluggable screw terminal	Relay outputs:	Max 24 V _{DC} , 60 W
Type:	Closing contact, monitored	24 V _{DC} outputs:	Max 250 V _{AC} , 125 VA 24 V _{DC} , ±10%, 200 mA
FAULT RELAY			
Connector:	Pluggable screw terminal		
Type:	Relay (COM, NO, NC)		
Relay outputs:	Max 24 V _{DC} , 60 W Max 250 V _{AC} , 125 VA		

Table 7: Technical Data – ENA2200

5.5.3 Placement and Stacking

The ENA2200 amplifier is designed to deliver full power at ambient temperatures up to 55 °C. As long as the equipment rack is well ventilated, amplifiers can be stacked with no extra space between them. It is however recommended to add 1 HU between every group of 4 amplifiers.

5.5.4 Mounting

The amplifier's mechanical construction is rigid enough to be mounted using only the four holes in the mounting flange to secure it to the rack. It is however considered good practice to mount support rails if the system is installed in a moving environment.

5.5.5 Power Supply

The ENA2200 shall be connected to the equipment rack's primary and secondary (DC) source of power.



Both power inputs are equipped with a lock, preventing the plug from falling out. Make sure that the plug is properly inserted, and that the lock is engaged.

The requirements for the power rails are listed in Table 7. The cables used for the power shall be dimensioned accordingly to voltage and current consumption of the ENA2200.

5.5.6 Grounding

It is always good practice to ground the cabinet of equipment installed in racks. This ensures safety and good EMC. The grounding connection of the ENA2200 should be connected to the equipment rack's ground strip using a ground wire of at least 0,75 mm².



If the ENA2200 isn't connected to ground, it will not be able to detect ground faults or short-circuits to ground.

5.5.7 Ethernet Connections

The ENA2200 shall be connected to the network using an Ethernet cable connected to the network switch.

5.5.8 Fault Relay

The ENA2200's fault relay will trigger whenever a fault is present in the amplifier. This relay is actively kept closed by the ENA2200, so it will trig even if the entire amplifier loses power. The connection to external equipment should be made according to the external equipment's requirements. When no faults are present in the amplifier, an electrical connection is established between the COM and NO terminals of the fault relay. When a fault is detected, or the amplifier loses power, this connection is removed and a connection between COM and NC is established.

The fault relay should be routed from the ENA2200 output to a terminal block in the equipment rack if required by the specific system.



NOTE

The fault relay on the system controller will trigger in parallel with the amplifier's. In most cases, it is sufficient to use only the fault relay on the system controller.

5.5.9 Control Inputs

The control inputs should be routed from the ENA2200 screw terminal to terminal blocks in the equipment rack. The number of inputs used depends on the specific system. See section 2.5 for details on using control inputs.

5.5.10 Control Outputs

The control outputs on the ENA2200 should be routed to terminal blocks in accordance with the specific system's needs. See section 2.5 for details on using control outputs.

5.5.11 Loudspeaker Connections

The ENA2200 has three different possibilities for loudspeaker connections; 8Ω, 70 volts and 100 volts. The 8Ω output is only intended for local monitoring of audio, and the power is therefore limited compared to the 70 and 100 volts lines.

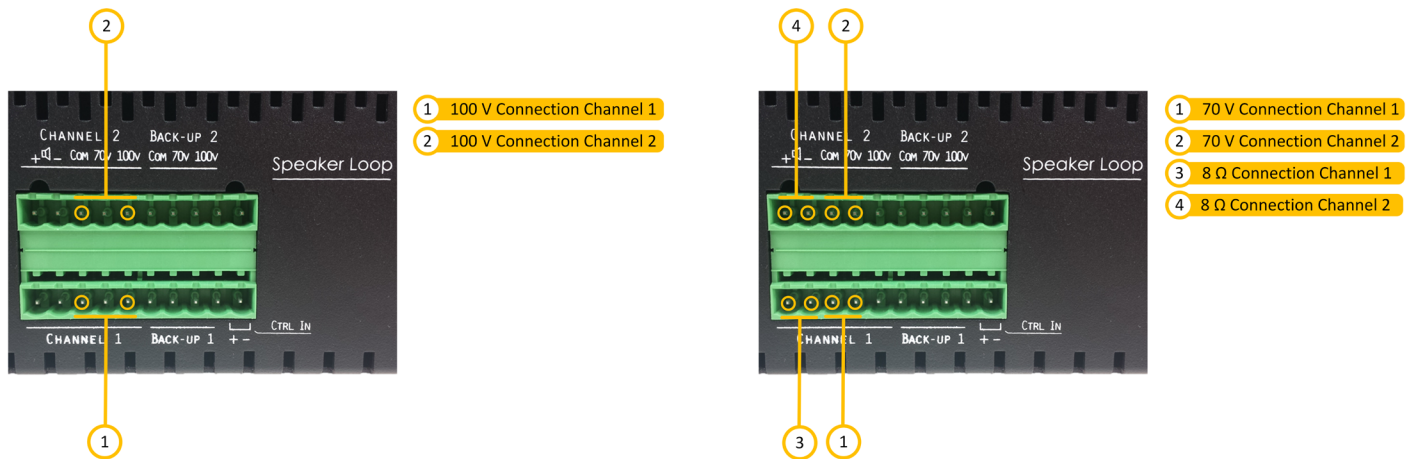

Figure 16: Loudspeaker Connections

The loudspeaker outputs from the amplifier should be routed to terminal blocks in the equipment rack according to the system requirements.

5.6 Network Interconnections

Audio and signaling between the ESC1 System Controller and the network amplifier ENA2200 are transmitted via Ethernet. The network connections are star-wired from the network switch. An example of a compliant switch is a Cisco IE-3000-8TC. An extension module, IEM-3000-4PC, provides 4 PoE ports to power user panels.

5.7 Installing the ECPIR Panels

In the context of evacuation systems, ECPIR panels, optionally combined with one or more EBMDR-8 expansion panels, are normally used as a fireman's panel, often combining requirements of a CIE into a customized panel. Although this section describes the installation of Voice Alarm Manual Control and Emergency Microphone panels, the resultant panels can in fact be classed as fireman's panels.

5.7.1 ECPIR-3P Overview

The ECPIR-P and ECPIR-3P are very similar. This section only provides a detailed overview of the ECPIR-3P panel. The installation of both panel types is exactly the same.

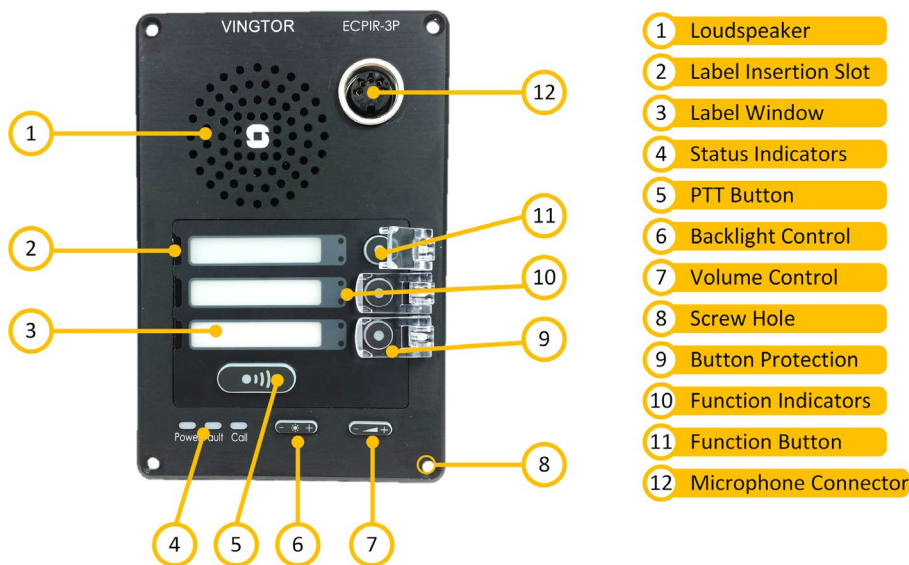

Figure 17: Front Side – ECPIR-3P

Loudspeaker: Loudspeaker for listening to recorded messages before broadcast.

Status Indicators: Indicates status for power, system and activity.

PTT Button: Push-To-Talk button.

Backlight Control: Button to adjust backlight of labels, buttons and indicators.

Volume Control: Button to adjust volume of the internal loudspeaker.

Screw Hole: 4 holes used to mount the panel.

Microphone Connector: DIN connection for gooseneck or handheld microphone.

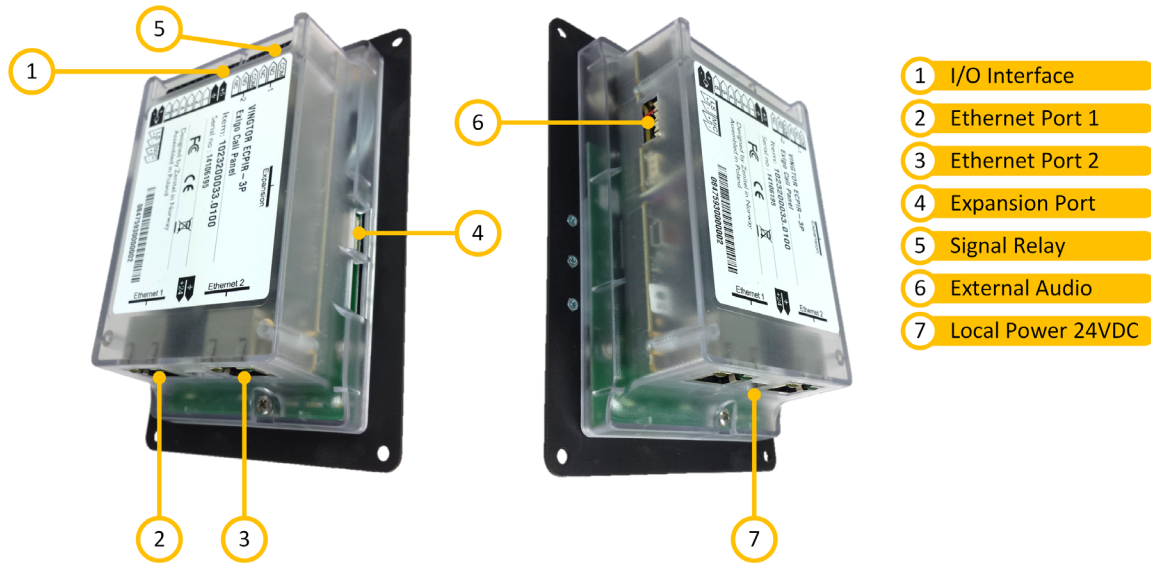

Figure 18: Rear Side – ECPIR-3P

I/O Interface: Interface for control outputs

Ethernet Port 1: Ethernet port number 1

Ethernet Port 2: Ethernet port number 2

Expansion Port: Connection for the first button expansion module - a white connector on top and an empty 'slot' below

Local Power: Local input for power supply

5.7.2 Placement

The ECPIR panels must be mounted in a cabinet that provides the following levels of access protection:

- Access Level 2: Buttons on the panel
- Access Level 3: Cables



NOTE

The cabinet is not part of the panel, and must be purchased from a supplier of suitable mounting equipment.

5.7.3 Power Supply

The ECPIR panels can be powered in 2 ways: Power over Ethernet (PoE) or local power. When using PoE the ECPIR-3P is automatically supplied with backup power, provided that the Cisco IE3000 switch is itself powered by the battery charger. Alternatively, the ECPIR panels can be powered from a local EN 54-4 approved power supply.

5.7.4 Ethernet

The access panels shall be connected to the Cisco IE3000 switch inside the main central equipment cabinet using Ethernet port 1.

5.7.5 Muting External Equipment

The ECPIR panels include two separate relays that can be used to mute local alarm bells or sounders when the panel is used as an Emergency Microphone Panel.

5.7.6 Microphone

The call panels ECPIR-P and ECPIR-3P must be equipped with a microphone, either a gooseneck or a handheld one. Both microphone types plug directly into the 5-pin DIN connector in the front of the panel. See Figure 17.

5.8 Installing the EBMDR-8 Button Expansion Module

5.8.1 EBMDR-8 Overview

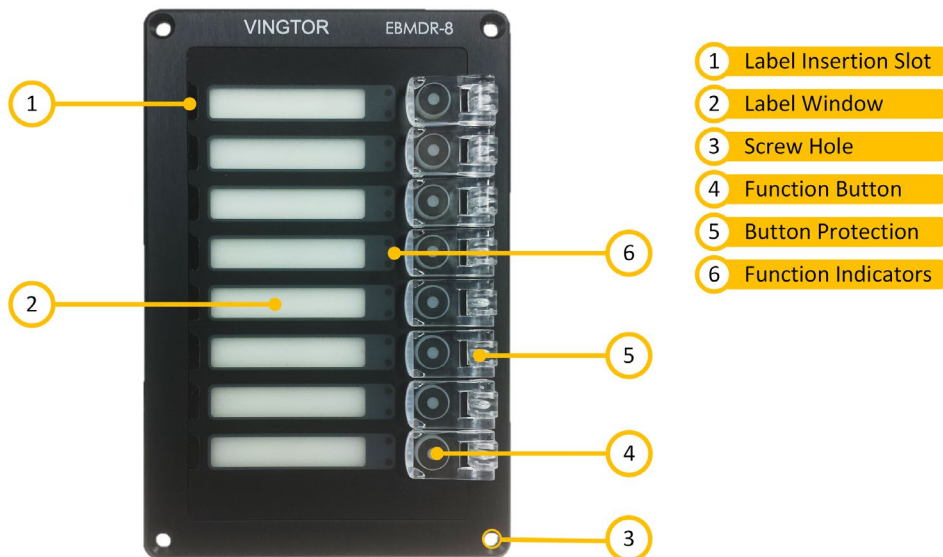

Figure 19: Front Side - EBMDR-8

Label Insertion Slot: Opening for the insertion of label for the button.

Label Window: Label is visible through this window. The label window is equipped with backlight.

Screw Hole: 4 screw holes to mount the panel.

Function Button: 8 buttons with removable flip covers.

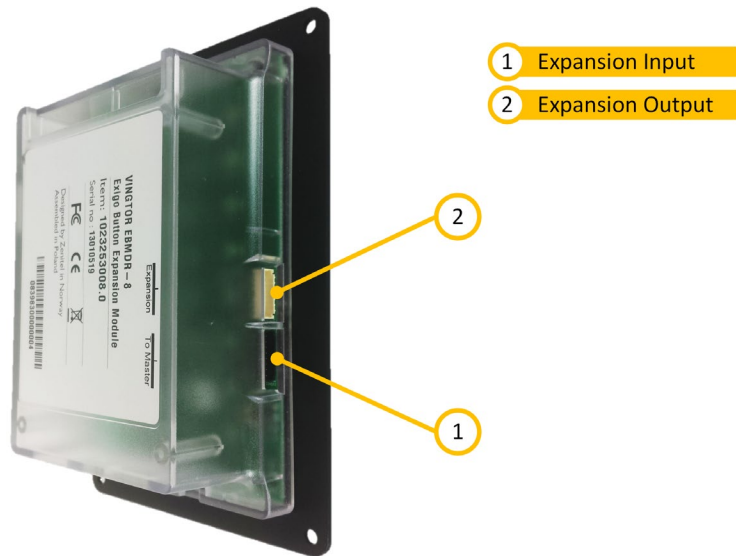

Figure 20: Rear Side – EBMDR-8

5.8.2 Placement

The EBMDR-8 panel is a slave unit for the ECPIR panels. Hence, it must always be mounted in conjunction with one of these master panels. The EBMDR-8 receives power from, and communicates through its master panel. The combination of panels must be mounted in a cabinet which provides the following level of access protection:

- Access Level 1: Unrestricted view of indicators
- Access Level 2: Buttons on the panel
- Access Level 3: Cables



NOTE

The cabinet is not part of the panel, and must be purchased from a supplier of suitable mounting equipment.

5.8.3 Connection

The small cable supplied with the module shall be used to connect the button module to its master panel or preceding module. If more than one button module is connected to the same master panel, these are daisy chained together. The white connector on the cable shall be connected to the matching white connector on the master panel or preceding module. The black connector on the cable shall be connected to the black connector on the module.



NOTE

Up to 4 EBMDR-8 panels may be daisy-chained to one master panel.

5.9 Installing the EAPII Access Panels

In the context of evacuation systems, EAPII access panels (EAPII-1 and EAPII-6), are normally used as a fireman's panel, often combining requirements of a CIE into a customized panel. Although this section describes the installation of Voice Alarm Manual Control and Emergency Microphone panels, the resultant panels can in fact be classed as fireman's panels.



NOTE

For detailed installation and connection procedures for the EAPII access panels, please refer to the document A00K11579 Exigo Access Panel EAPII Mounting Manual.

5.9.1 EAPII Overview

The EAPII-1 and EAPII-6 only differ by the number of buttons that are available on the front panel. The units will be referred to as EAPII.

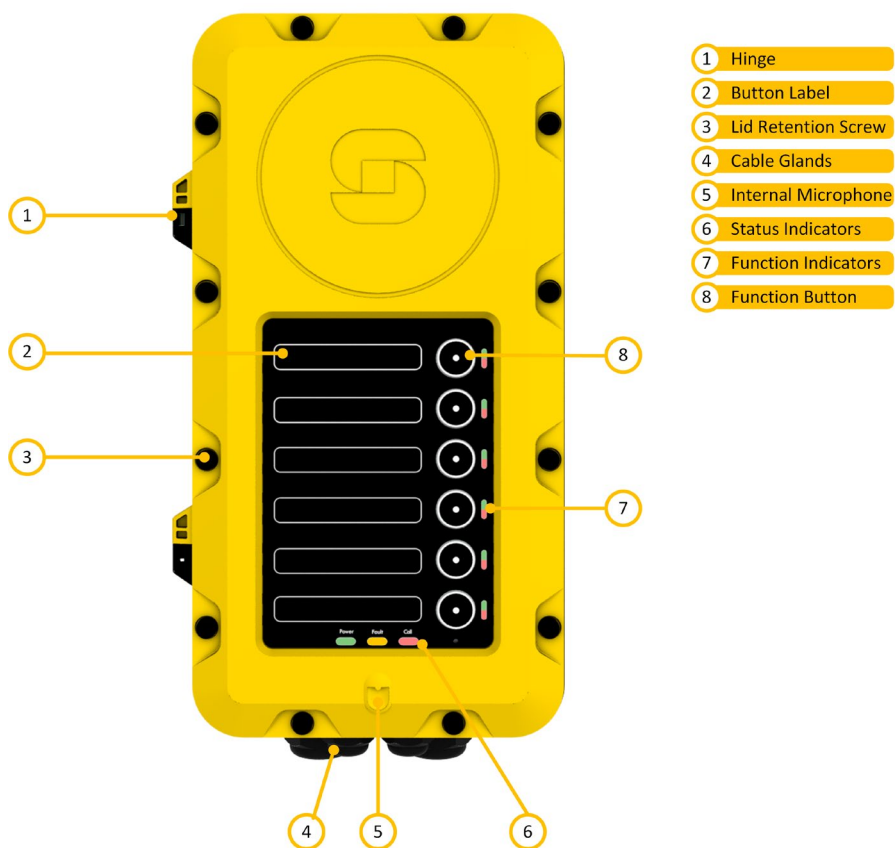

Figure 21: EAPII-6

All connections are inside the unit. Cables enter the unit through glands at the bottom of the unit.

5.9.2 Placement

The EAPII must be mounted in a cabinet which provides the following level of access restriction:

- Access level 1: Unrestricted view of indicators
- Access level 2: Buttons on the panel
- Access level 3: Cables



NOTE

The cabinet is not part of the panel, and must be purchased from a supplier of suitable mounting equipment.

5.9.3 Power Supply

The EAPII can be powered in 2 ways: Power over Ethernet (PoE) or local power. When using PoE the EAPII is automatically supplied with backup power, provided that the Cisco IE3000 switch is itself powered by the battery charger. Alternatively, the EAPII can be powered from a local EN 54-4 approved power supply.

5.9.4 Ethernet

The access panels shall be connected to the Cisco IE3000 switch inside the central equipment cabinet.

5.9.5 Muting External Equipment

The EAPII panel includes two separate relays that can be used to mute local alarm bells or sounders when the panel is used as an Emergency Microphone Panel.

5.9.6 Microphone

The EAPII panels must be equipped with the EMMAI-2H handheld microphone. The microphone is wired directly to a terminal strip inside the panel.

6 EN 54-16 Programming & Wiring

This section provides specific programming and wiring information for a typical EN 54-16 compliant system. For larger systems the principle is the same and it is therefore easy to scale this example configuration up. The configuration base consists of:

- 1x ESC1 System Controller
- 1x ENA2200 Network Amplifier
- 1x Cisco IE3000 Switch with PoE module
- 1x combined Voice Alarm Manual Control and Emergency Microphone Panel - ECPIR-3P with EBMDR-8 expansion module
- Battery charger with batteries
- EN 54-24 certified 100V speakers

6.1 Configuration Reference List

The Exigo configuration reference list consists of a set of tables summarizing the main information needed to configure an Exigo system. Configuration data in the following sections is merely an example.

6.1.1 Central Equipment

Type	Description	Directory Number	Device Name	IP Address	Subnet	Location
ESC1	System Controller, PSC	-	-	10.5.101.10	255.255.0.0	-
ESC1	System Controller, SSC	013010	ESC1 1	10.5.101.20	255.255.0.0	System Rack
ENA2200	Network Amplifier	012010	ENA2200 1	10.5.101.30	255.255.0.0	System Rack



NOTE

The two rows for the ESC1 System Controller describe the same physical device. The ESC1 consists of two processors, the PSC and the SSC.

6.1.2 Access Panels

Type	Description	Directory Number	Device Name	IP Address	Subnet	Location
ECPIR-3P EBMDR-8	Call Panel, PTT + 3 Buttons Expansion panel	011010	ECPIR-3P 1	10.5.101.41	255.255.0.0	Lobby
ECPIR-P EBMDR-8	Call Panel, PTT Expansion panel	011020	ECPIR-P 2	10.5.101.40	255.255.0.0	Landing, 1 st Floor
EAPII-1		011030	EAPII-1 3	10.5.101.50	255.255.0.0	Back Gate
EAPII-6		011040	EAPII-6 4	10.5.101.51	255.255.0.0	Back Entrance

6.1.3 Zones

Zone	Display Name	Description
1	Offices	Offices, Ground Floor
2	Canteen	Employee Canteen, First Floor

6.1.4 Amplifier Channels

For each zone, one or more amplifier channels must be used. The table below is used to assign amplifier channels and to ensure that each amplifier channel isn't overloaded.

The various columns in the table are explained below.

Loop: The identification of the speaker loop. This should correspond to the number used on drawings, etc.

Type: The type of amplifier used for the loop.

Amplifier: The identification (name) and number of the amplifier used for the loop.

Channel: The channel number of the amplifier used for the loop.

Mon: Should monitoring of the loop be enabled or not – For EN 54-16 compliant systems this must always be enabled.

LET: The number of line end transponders on the loop.

Z1 – Zn: The loudspeaker load for the loop.

Loop	Type	Amplifier	Channel	Mon	LET	Z1	Z2
A1	ENA2200	ENA2200 1	1	On	1	88W	
A2	ENA2200	ENA2200 1	2	On	1		75W
Watts per zone:						88W	75W

Table 8: Channel Assignment

6.1.5 Line End Transponder Configuration

Each amplifier can have a total of 10 LET units, divided among the channels. The table below shows the configuration of the LET units per amplifier channel.

Loop	Amplifier	Channel	LET 1	LET 2	# LETs
A1	ENA2200 1	1	X		1
A2	ENA2200 1	2		x	1

Table 9: Line End Transponders

6.2 System Parameters

6.2.1 Voice Evacuation Messages

The voice evacuation messages in the system must be planned, defined and configured.

Alarm ID	Name	Fixed Zone	Priority	Storage Location
1	Evacuate the building	All Zones	9	ESC1 1
2	Evacuate ground floor	Ground Floor	10	ESC1 1
3	Evacuate first floor	First Floor	11	ESC1 1

Table 10: Voice Evacuation Messages

6.2.2 Access Control

The Exigo system can be set up with access control to the user interface on the system controllers and amplifiers. The different users must be assigned an access level and a PIN code.

User ID	Level	PIN Code	Name
1	1	1111	System Administrator
2	2	2222	Maintenance

Table 11: User Access Definitions

6.3 Control Inputs & Outputs

6.3.1 Control Outputs

In most systems, several control outputs must be configured. These control outputs are usually used to signal other systems, or to activate/deactivate other parts of the safety and emergency system.

Output ID	Priority	Description	Trigger Situation
ESC1.CO_1		Voice Alarm Condition	During any voice alarm situation

Table 12: Control outputs

The output IDs are a combination of the device ID and the control output number on that device. In the table above, **ESC1.CO_1** refers to control output number 1 on the system controller.

6.3.2 Control Inputs

Control inputs are used by other systems or actuators to signal and give commands to the Exigo system. Control inputs must be assigned a function and a priority.

A number of the inputs will be connected to outputs of the CIE. Refer to the documentation of the CIE and match the VACIE input configuration accordingly.

Input ID	Action	Priority	Functions	Trigger	Zones	Comment
ESC1.CI_1	Start fire alarm, all zones	1	Start fire alarm, all zones	Set	All zones	Monitored, normally open
ESC1.CI_2	Start fire alarm, zone 1	2	Start fire alarm, zone 1	Set	Ground floor	Monitored, normally open
ESC1.CI_3	Start fire alarm, zone 2	2	Start fire alarm, zone 2	Set	First floor	Monitored, normally open
ESC1.CI_4	Reset alarms	3	Reset alarms	Set	All zones	Monitored, normally open
ESC1.CI_5	Silence alarms	4	Silence alarms	Set	All zones	Monitored, normally open

Table 13: Control inputs

The input IDs are a combination of the device ID and the control input number on that device. In the table above, e.g. **ESC1.CI_1** refers to control input number 1 on the system controller.

6.4 Access Panel Buttons

Panels can be configured as:

- Voice Alarm Manual Control panel
- Emergency Microphone panel
- A combination of the 2 panel types above
- General Purpose PA panel

This manual only concerns itself with the first 3 types in the list above.

The buttons on the access panels are planned by using one table per access panel. The number of buttons in the table depends on the access panel type.

6.4.1 Access Panel CP-1

Access Panel CP-1: Combination of ECPIR-3P and one expansion module EBMDR-8

Button	Function	Priority	Comments
ptt	Push-To-Talk	15	Speak when Call LED is lit
p1	Select all zones for live emergency announcement	12	Activate emergency microphone
p2	Select voice alarm message for all zones	10	Manual alarm, all zones
p3	Fire Alarm Cancel	-	Cancel fire alarm
e1-p1	Select voice alarm message for ground floor	6	Manual alarm, ground floor
e1-p2	Select voice alarm message for first floor	8	Manual alarm, first floor

Table 14: Button Definitions – CP-1

The PTT button and the three buttons named p1, p2 and p3 are the buttons on the ECPIR-3P access panel. The buttons named ex-py are the buttons on the expansion module where 'x' is the expansion module number and 'y' is the button number on that module. E.g. e1-p6 is button 6 on the expansion module.

6.4.2 Access Panel Control Outputs

In most systems, several control outputs must be configured. These control outputs are usually used to signal other systems, or to activate/deactivate other parts of the safety and emergency system.

Output ID	Priority	Description	Trigger situation
CP-1.CO_1	-	Mute nearby sounders	Mute nearby sounders when emergency microphone is live

Table 15: Control Outputs

The output IDs are a combination of the device ID and the control output number on that device. In the table above, **CP-1.CO_1** refers to control output number 1 on Access Panel CP-1.

7 Maintenance

7.1 Fuse Ratings

All fuses and their ratings of the different Exigo components are listed in this section for easy reference.

Equipment type	Fuse	Rating
ESC1	Mains DC fuse	4.0 A
	Mains AC fuse	1.0 A
	Internal fuse to the main board	3.15 A
ENA2200	Internal fuse to control electronics	2 A
	Internal fuse to audio channel 1 network amplifier	6.3 A
	Internal fuse to audio channel 1 network amplifier	6.3 A
	Mains AC	6.3 A
	Internal fuse for Mains DC (not field serviceable)	2x 25 A in parallel

Table 16: Fuses

7.2 Factory Reset on ESC1 System Controller

The Primary System Controller and the Secondary System Controller of the ESC1 are reset separately to factory default settings.

7.2.1 Resetting Primary System Controller

To reset the Primary System Controller (AMC-IP board) to factory defaults:

- Log into the PSC web interface
- Select **System Maintenance > System Recovery**



Select one of two ways to do a factory reset:

- **Load Factory Defaults** - This resets the configuration data. Current IP settings are retained.
- **Clean & Factory Default** - This resets the configuration data. It also deletes license, SysLog and Backup files, as well as the Exigo mode. Current IP settings are retained.
- **Chilly Restart** - This resets the system.

7.2.2 Resetting Secondary System Controller

7.2.2.1 Resetting from Web Interface

To reset the Secondary System Controller to factory defaults:

- Log into the SSC web interface
- Select **Station Administration > Reboot**

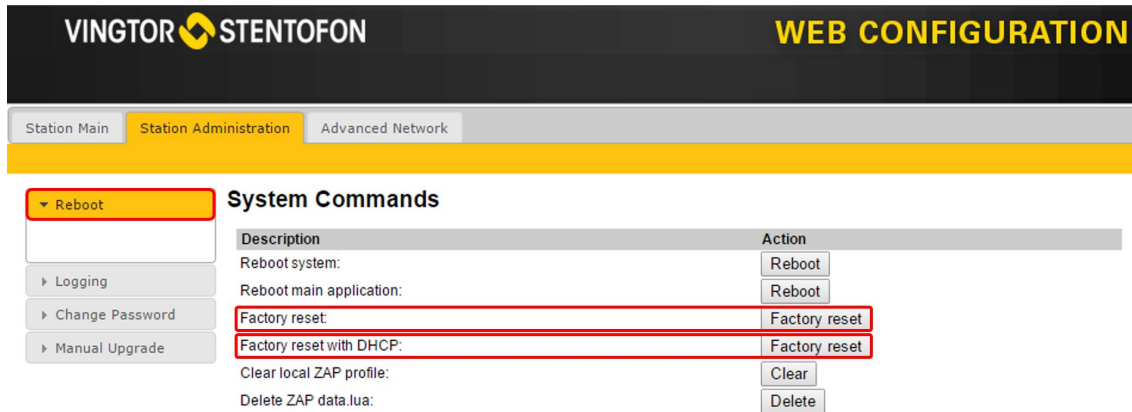

Select one of two ways to do a factory reset:

- **Factory Reset** - This resets the configuration data. The SSC gets the default IP address 169.254.1.100.
- **Factory Reset with DHCP** - This resets the configuration data. The SSC is set to receive an IP address from DHCP.

7.2.2.2 Resetting from GUI Display

It is also possible to do a Factory Reset from the GUI display on the system controller front panel.

- Select **Service > Restart & Restore**

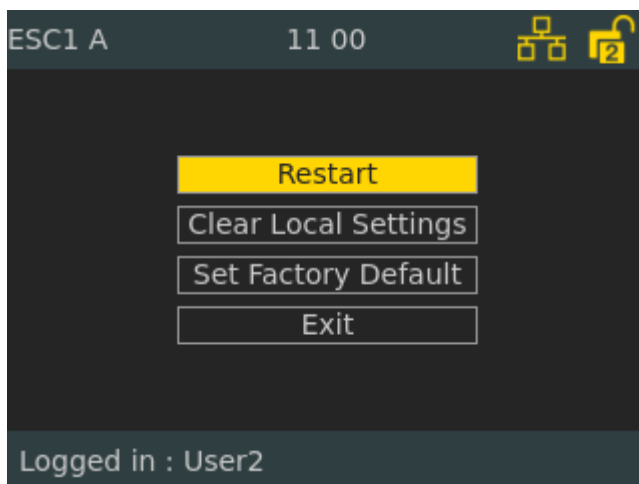

Factory Reset from the GUI display will not restart the applications responsible for audio and monitoring (EdgeAudioClient & SysMon). Hence, it is recommended to do a factory reset from the web interface if possible.

7.3 Factory Reset on ENA Amplifier

7.3.1 Resetting from Web Interface

To reset the ENA amplifier to factory defaults:

- Log into the amplifier web interface
- Select **Station Administration > Reboot**

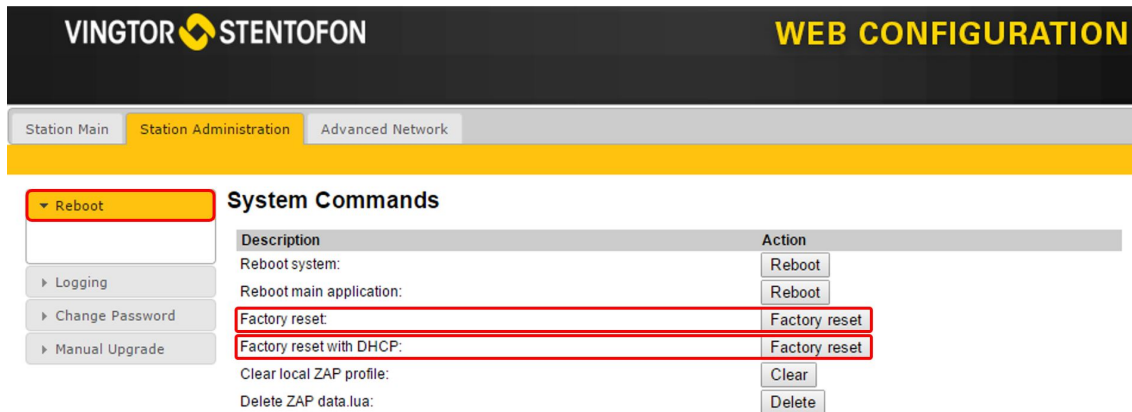

Select one of two ways to do a factory reset:

- **Factory Reset** - This resets the configuration data. The amplifier gets the default IP address 169.254.1.100.
- **Factory Reset with DHCP** - This resets the configuration data. The amplifier is set to receive an IP address from DHCP.

7.3.2 Resetting from GUI Display

It is also possible to do a Factory Reset from the GUI display on the amplifier front panel.

- Select **Service > Restart & Restore**

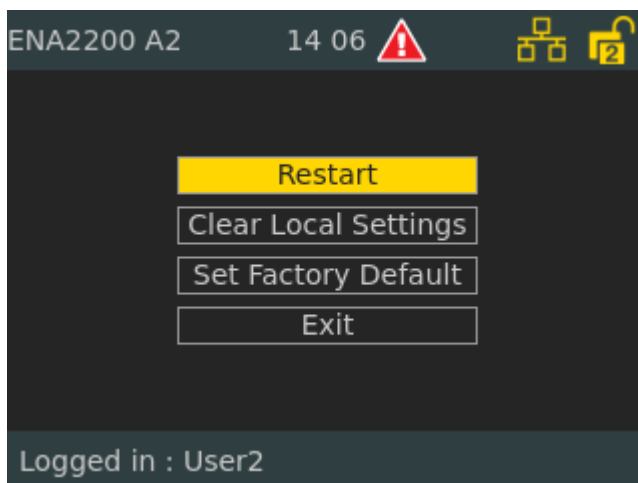

Factory Reset from the GUI display will not restart the applications responsible for audio and monitoring (EdgeAudioClient & SysMon). Hence, it is recommended to do a factory reset from the web interface if possible.

7.4 Factory Reset on Access Panels

To reset an access panel to factory defaults:

- Log into the access panel web interface
- Select **Station Administration > Reboot**

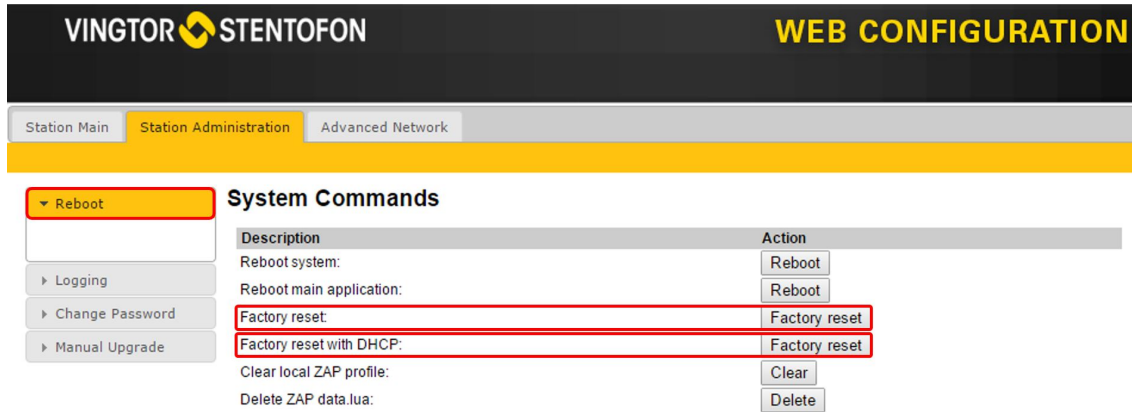

Select one of two ways to do a factory reset:

- **Factory Reset** - This resets the configuration data. The access panel gets the default IP address 169.254.1.100.
- **Factory Reset with DHCP** - This resets the configuration data. The access panel is set to receive an IP address from DHCP.

7.5 Replacing System Devices

Refer to the following replacement manuals for Exigo devices available on www.zenitel.com.

- A100K11606 Replacing PSC on ESC1 System Controller
- A100K11598 Replacing PSU on ESC1 System Controller
- A100K11605 Replacing ENA2200 Amplifier
- A100K11600 Replacing Amplifier Module on ENA2200
- A100K11599 Replacing PSU on ENA2200
- A100K11607 Replacing Access Panel ECPIR

When devices are replaced in the system, they can be configured remotely from the Exigo Management Tool (EMT).

To configure a replaced device in EMT:

1. Click the **OPERATION** tab

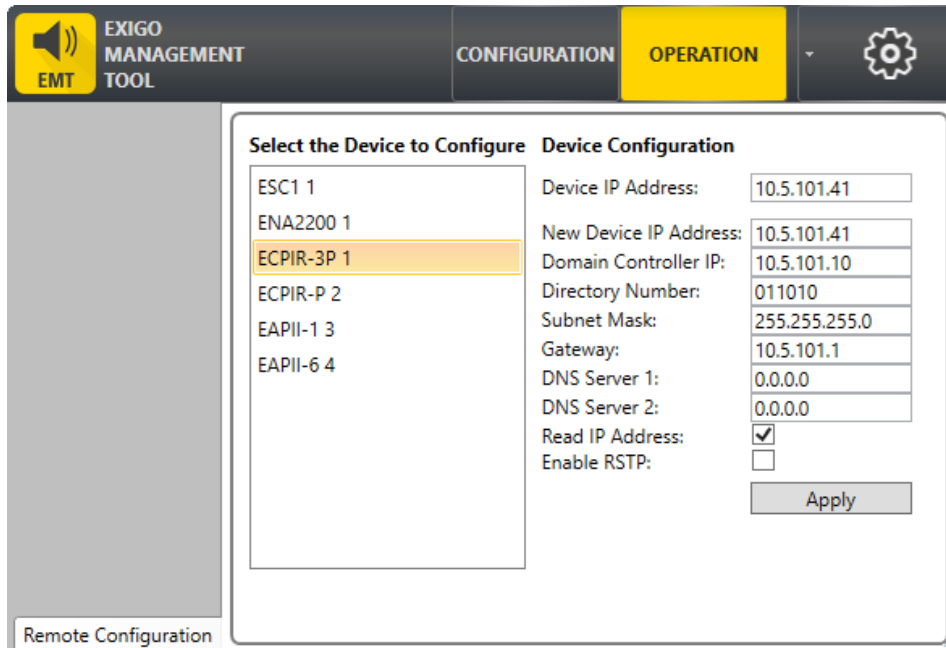

2. Select the replaced device to configure
3. Enter relevant values for parameters such as **New Device IP Address**, etc.
4. Click **Apply**

Note that Device IP Address is the current IP address of the device. The IP address can be found on the device's interface or via the speaker. Make sure that the device is set up with an identical IP address as that of the device it replaces to ensure proper operation. Consult the project documentation to implement this correctly.

7.6 Maintenance of System Controller

The configuration of the system controller's primary system controller board (AMC-IP card) can be backed up to a PC and restored to another board. The system controller's primary system controller board is pluggable and can be changed via a simple maintenance procedure.

7.6.1 Battery Life

The battery on the AMC-IP card in the ESC1 System Controller has a life span of 10 years.

The battery type is a standard **CR2032 coin cell** (see *Figure 13: Internal View – ESC1*).

The battery should be changed after a period of 7 years. For the sake of preventive maintenance, it is recommended that the battery be changed every 5 years.

When the battery is depleted and the power goes off, the clock will reset. If NTP is available, the clock will utilize this.

Powering up without a battery will always generate a 'chilly restart' but the configuration data and logs will not be lost.

However, ongoing activities such as recall messages will be lost.

7.7 Maintenance on Speaker Loops

The system controller can activate/deactivate amplifier loop outputs, rendering the output free of any voltage by disabling the amplifier circuit. The system controller and the affected amplifier(s) will enable their disabled indicators when speaker loops are disabled by this function.

This function can be used when maintenance must be done on speaker loops during operation.

7.8 Tick Tone

The system controller can generate a tick tone and route this to the selected zones. This function can be used to audibly verify that the system works properly.

The tick tone can be either a “clicking sound” or a spoken message. The spoken message will repeat the zone number and/or the amplifier’s ID and audio channel number.

7.9 Indicator Test

The system controller can initiate a test of all indicators. This test can either be local or global. The local test will turn on the indicators (visible and audible) for the system controller only. A global test will initiate the indicator test for all devices controlled by the system controller. The indicators will be activated for 5 seconds, and then turned off. Indicator tests for access panels and amplifiers can also be initiated from local menus or buttons where available.

7.10 Software Upgrade

Software in the system controller, amplifier and access panels can be upgraded by uploading the software to the individual devices. The software upgrade procedure is the same for all the devices.

7.10.1 Prerequisites

The upgrade method requires that a TFTP Server is available and that the latest software image files have been downloaded from ExigoWiki at <https://exigo.zenitel.com>. During the upgrade process, the device will connect to the TFTP Server and download the software. Start by installing a suitable TFTP Server program on your PC.

7.10.2 Upgrading the Software

- 1 Download the Exigo software package **exi-4.x.x.x** and save it to a folder on your PC
- 2 Start the TFTP server program and **browse** to the folder where the image files **exi-4.x.x.x** are located
- 3 Log on to the device’s web interface
- 4 Select **Station Administration > Manual Upgrade**

Station Main	Station Administration	Advanced Alphacom	Advanced Network
--------------	------------------------	-------------------	------------------

- ▶ Reboot
- ▶ Logging
- ▶ Licensing
- ▶ Change Password
- ▶ Backup and Restore
- ▼ Manual Upgrade

Enter the following parameters:

TFTP-server IP: - - -

Image file

- 5 Enter the IP address of the **TFTP server** where the software is located
- 6 Enter the prefix (e.g. exi-4.x.x.x) to the software image files in the **Image file** field
- 7 Click **Save settings** to store the data

The device will now try to contact the TFTP server. If the response is **ipkg package install_OK** the settings are saved, and the **Upgrade** button will appear.

- ▶ Reboot
- ▶ Logging
- ▶ Licensing
- ▶ Change Password
- ▶ Backup and Restore
- ▼ Manual Upgrade

Image-filename: exi-4.1.3.1

ipkg package install OK!
Some features may require a reboot to be activated.

```

Doing ipkg tftp download and install
Downgrading exi on root from 4.1.3.1-1 to 4.1.3.1...
Downgrading exi on root from 4.1.3.1-1 to 4.1.3.1...
Preparing to install a exi software
Downgrading exi on root from 4.1.3.1-1 to 4.1.3.1...
Downgrading exi on root from 4.1.3.1-1 to 4.1.3.1...
Downgrading exi on root from 4.1.3.1-1 to 4.1.3.1...
Downgrading exi on root from 4.1.3.1-1 to 4.1.3.1...
Configuring exi
Parameter 1:
No devicetree upgrade
No bootloader upgrade
Preparing normal update, please wait
Images Info file: exi-4.1.3.1_bootupgradeinfo.txt
Cleaning Environment Export folder, prepare for new upgrade config.
Updating new barebox env with upgrade_config data, please wait
dumping barebox environment to /tmp/bareboxenv
loading env from file /tmp/bbenvdump to /tmp/bareboxenv
Count: 0
tsi_info file: exi-4.1.3.1_bootupgradeinfo.txt
copying data to barebox
rootfs directory exists
storing xml file to barebox
storing srv xml file to barebox
storing web config (umconfig) to barebox
storing addressbook to barebox
storing dropbear_rsa_host_key to barebox
storing dropbear_rsa_host_key to barebox
Saving wpa certificate
Saving user wpa certificate
Saving user wpa priv certificate
ST Environment version 2014.09.03
upgrade directory exists, cleaning..
storing barebox upgrade_config_file
writing barebox environment
saving contents of /tmp/bareboxenv to file /tmp/bbenvsave

Erasing 128 Kibyte @ 0 -- 0 % complete
Erasing 128 Kibyte @ 20000 -- 50 % complete
Erasing 128 Kibyte @ 20000 -- 100 % complete
Writing data to block 0 at offset 0x0
loading barebox env to flash, please wait
Bootloader environment updated. Reboot system to tftp upgrade new kernel and rootfs!
Successfully terminated.

```

Press 'Upgrade' to complete full upgrade procedure (reboot)

- 8 Click the **Upgrade** button to upgrade the software on the Exigo device.

The upgrade procedure takes about 3 minutes. The process can be monitored by clicking the Log viewer tab in the TFTP server program.

A System Controller Menu Structure

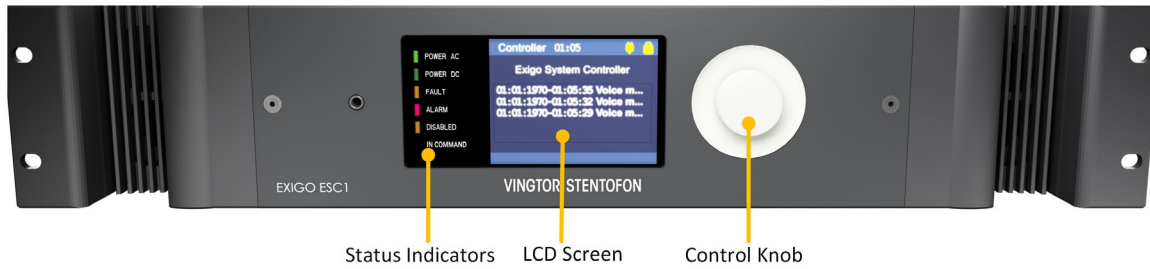

Figure 22: ESC1 System Controller Front Panel

The user's means of interaction with the system controller is through the control knob. The control knob is located next to the LCD screen and can be turned clockwise and counter clockwise, as well as being pressed.

Items in the menu system are selected by turning the control knob:

- 9 Clockwise rotation will move the 'selector' to the right or down
- 10 Counter-clockwise rotation will move the 'selector' to the left or up

Whether the selector is moved up/down or left/right depends on the current menu displayed.

- 11 Press the control knob to activate the selected menu item
- 12 **Press and hold** the knob to return to the previous view

To change or input the parameter values in the selected menu item:

1. Turn the control knob to move between the parameter fields
2. Press the control knob to select the parameter field
 - The **field turns green** to indicate that it is selected and ready for input value
3. Turn the control knob to change the parameter value
4. Press the control knob to select the parameter value

Factory Default with DHCP

To remove all configuration data, set the default configuration and reset to DHCP, press and hold the control knob for 20 seconds while booting up the System Controller.

A.1 Idle Screen

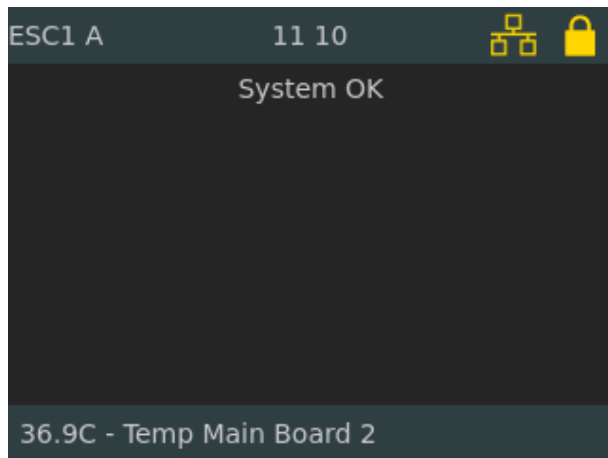

System up and running without any faults or warnings

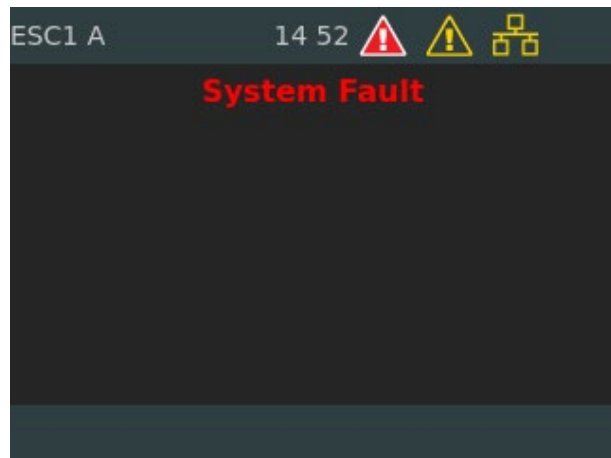

Red icon indicates fault in the system and yellow icon are warnings

The system controller can display two different idle screens, depending on whether the controller is responsible for fault handling or not.

General Information

The idle screen will always display the following general information:

- Current system time
- A line saying that this unit is a system controller
- A line saying that the system is OK or not, or that the system is managed by another controller

Status Icons



Fault

A red icon indicating that there are faults present in the system controller / system.

Warnings







A yellow icon indicating that there are warnings present in the system controller / system.

Locked / Unlocked

A padlock icon indicating whether the system controller's user interface is locked or not.

ESC Connection Status

These status icons reflect whether the device has a connection to the PSC/Domain Controller. The two lower squares of the icon reflect ESC-A controller (left) and ESC-B controller (right).

Icon	Meaning
	Single system: ESC controller connected.
	Single system: ESC controller disconnected.
	A-B system: ESC-A and ESC-B controllers connected.
	A-B system: ESC-A controller disconnected, ESC-B controller connected.
	A-B system: ESC-A controller connected, ESC-B controller disconnected.
	A-B system: ESC-A and ESC-B controllers disconnected.

A.1.1 Idle Screen Examples

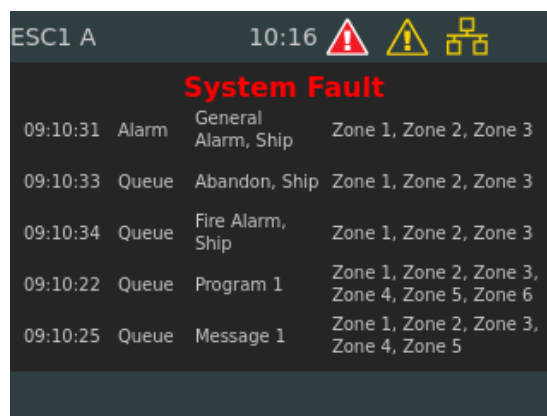
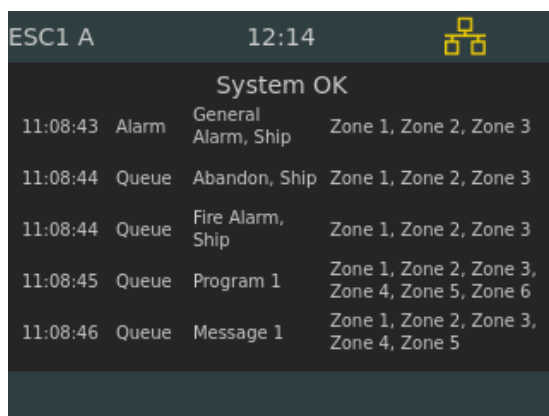
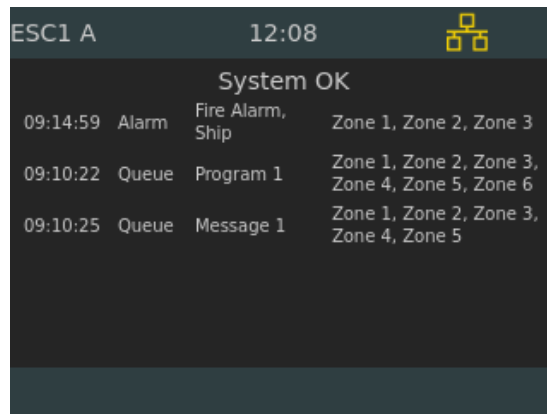
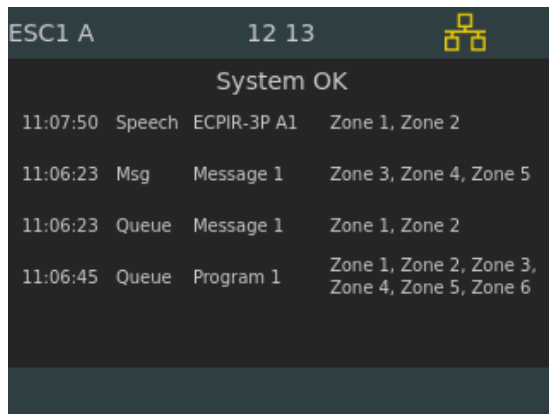

Column 1: Time when broadcast was started

Column 2: Broadcast Status

PA Call : Live speech from Call Panel

Prog : Program distribution setup

Msg : Message

Alarm : General Alarm

Queue : Broadcast is queued - set on hold while higher priority call is active in one of the same zone(s)

Column 3: Call Source, e.g. Live speech device, Message, Program.

Column 4: Zone destinations.

A.2 Access Control

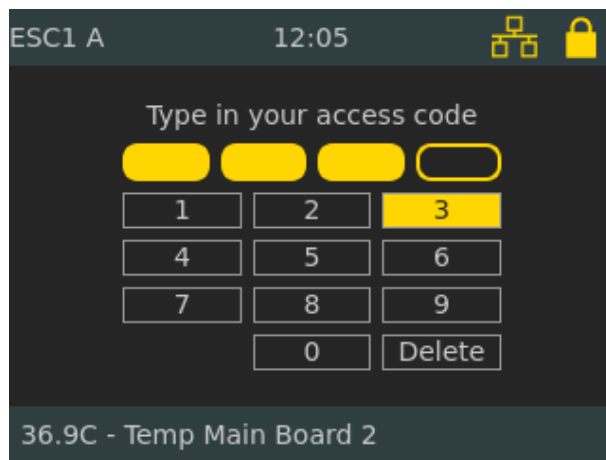
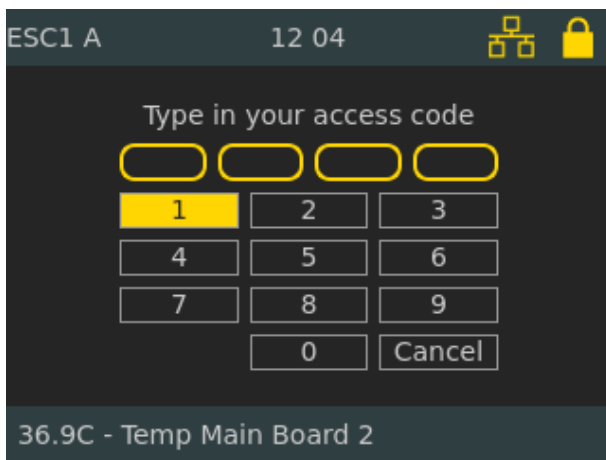

Access to the system controller is via a PIN code. There are two access levels. For Access Level 1 and Access Level 2 the **default PIN codes** are **1111** and **2222** respectively.

- Turn the control knob to select the number
- Press the control knob to enter the number

A.3 System Controller Menu Options

System Fault & Warning

System Fault List: lists all active faults in the system

Reset System Fault List: resets all acknowledged faults in the system

System Warning List: lists of all active warning messages for the system

Service

Local Message List: lists all active fault and warning messages for the system controller

Headphone: selects audio source and adjusts volume of headphone

Audio Output State: restarts the audio output channel when an output is shut down

Restart & Restore: restarts software and restores factory settings

Settings

General: sets menu timeout

Audio Output Volume: changes the output volume locally

Audio Input Gain: sets gain for microphone and line

Display: sets display parameters

Information

Device Info: shows information like HW board, software packages, Linux kernel, etc.

Network: displays network information for the system controller

Attached Devices: list all devices connected to the system controller

Control Input: displays status of the control input

Control Output: displays status of the control output

Diagnostic: displays diagnostics of the system controller

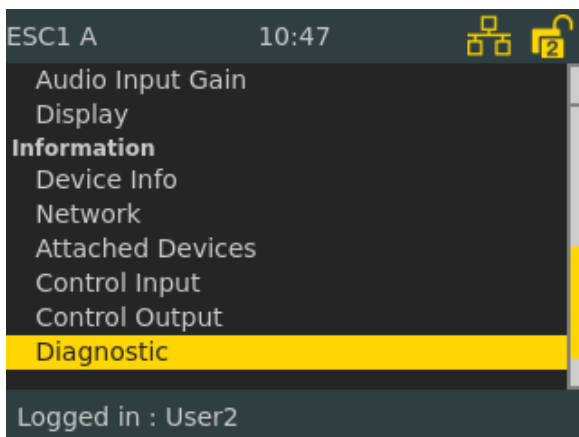
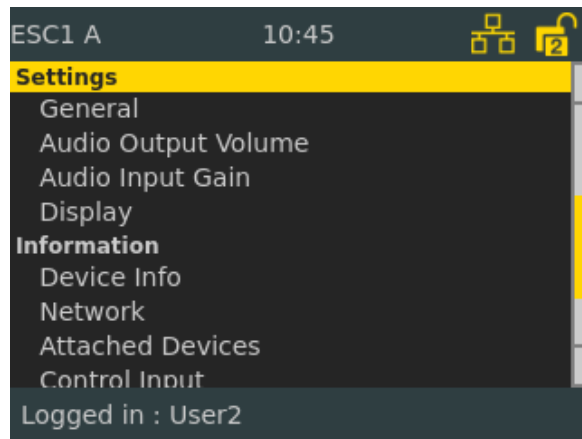
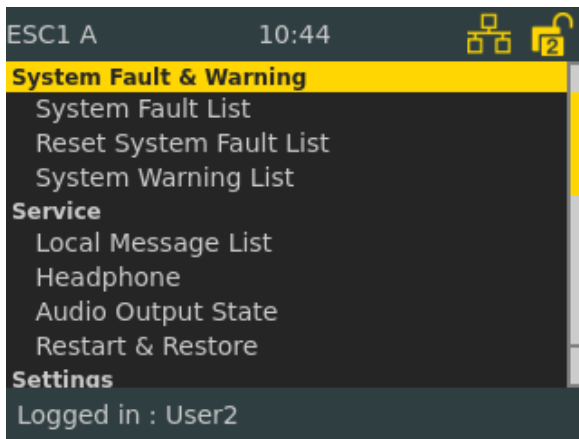

A.4 System Fault & Warning

The submenu for faults and warnings is only available if the system controller is in control of faults. In systems with several system controllers, it is possible to set up the system controllers to forward their faults to one centrally located system controller. When faults are forwarded, they cannot be handled locally.

A.4.1 System Fault List

Access Level = 1

The fault list displays all active faults in the system. One fault is displayed per page and it is clearly visible if more faults are in the list. The severity levels are: Error, Critical, Emergency.

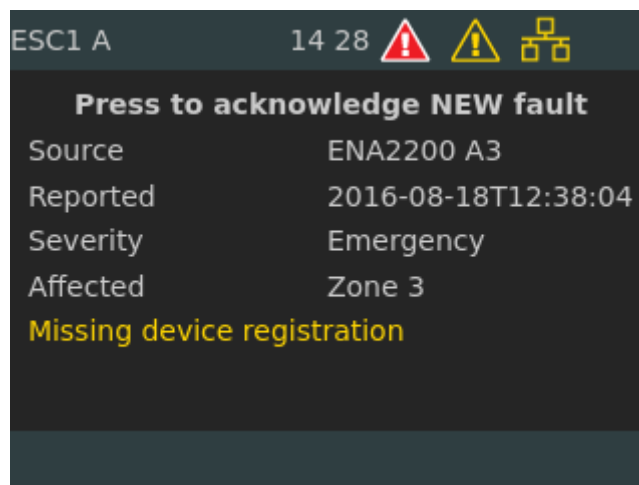

A new fault requires acknowledgement. Press the control knob to acknowledge.

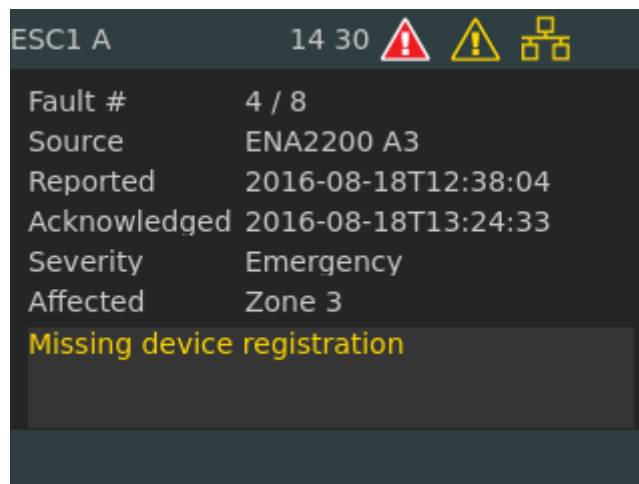

The new acknowledged fault will now be found in the fault list.

- Turn the control knob to scroll through several pages of faults.

The fault page displays all relevant information about the fault:

- Fault caption
- Time of detection
- System component reporting the fault
- Zones affected by the fault
- Acknowledgement status

When the Fault is no longer active/valid, it is possible to remove the fault from the system.

To reset the fault:

- Press the control knob
- Turn the control knob to select **Yes** and press the control knob to execute

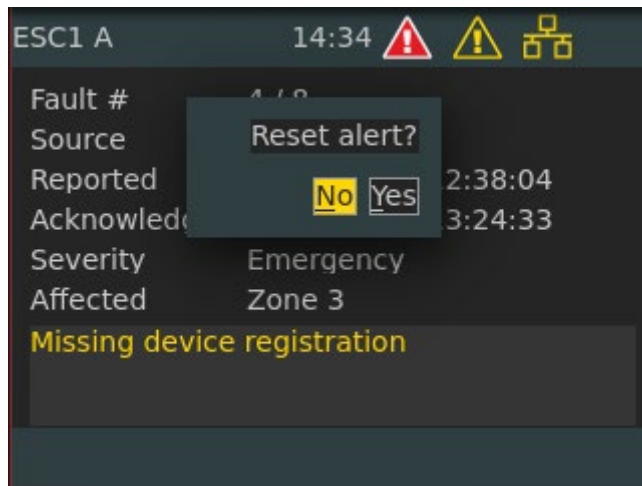

A.4.2 Reset System Fault List

Access Level = 1

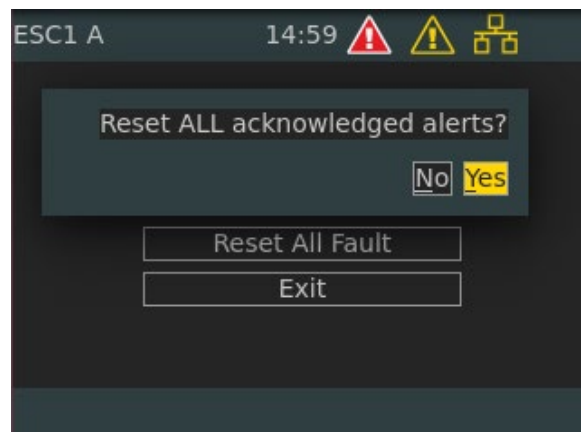
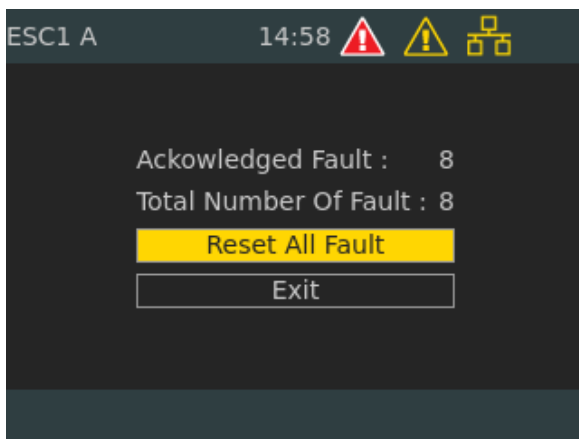

This function will try to reset all acknowledged faults in the system. This option is only available if there is at least one acknowledged fault in the fault list. The system will check that each and every fault being reset no longer is present, before clearing it from the list. If the system detects that the fault is still present, the visual and audible indicators on the system controller will be retriggered and the fault will remain in the list. If the fault is no longer present, it will be removed from the fault list and added to the system log history.

A.4.3 System Warning List

Access Level = 1

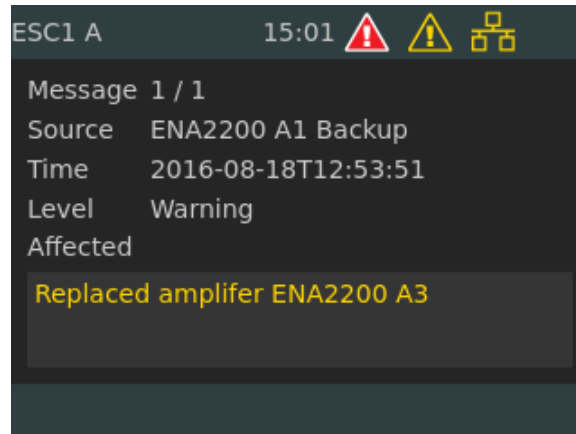

This is a list of all active warning messages for the system. The message displays relevant information on:

- Time of detection
- Security level
- Zones affected
- Description of the fault
- Time of acknowledgement

A.5 Service

The submenu for service and maintenance contains all functions related to service and maintenance of the system.

A.5.1 Local Message List

Access Level = 1

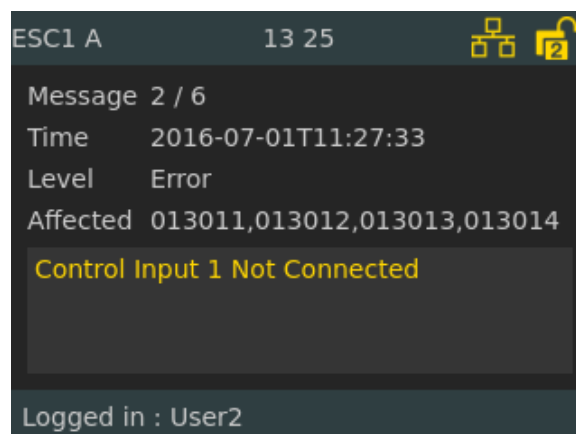

This is a list of all active fault and warning messages for the system controller. The message displays relevant information on:

- Time of detection
- Security level

- Zones affected
- Description of the fault
- Time of acknowledgement

A.5.2 Headphone

Access Level = 1

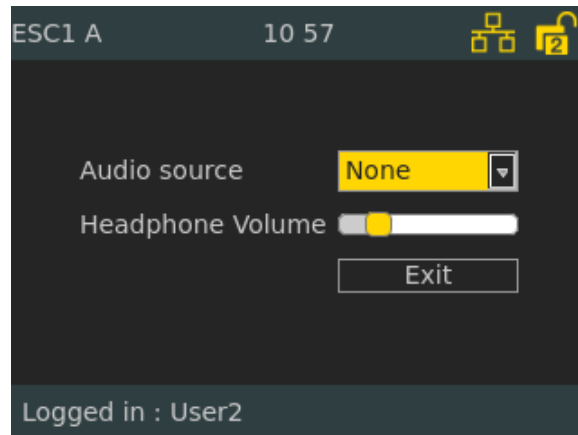

The headphone submenu is only available when a headset is connected to the system controller, and will allow an operator to select the following audio source to monitor:

- MicIn
- LinIn
- AudioStream

Set the volume for the headphone output by turning the control knob.

A.5.3 Audio Output State

Access Level = 1

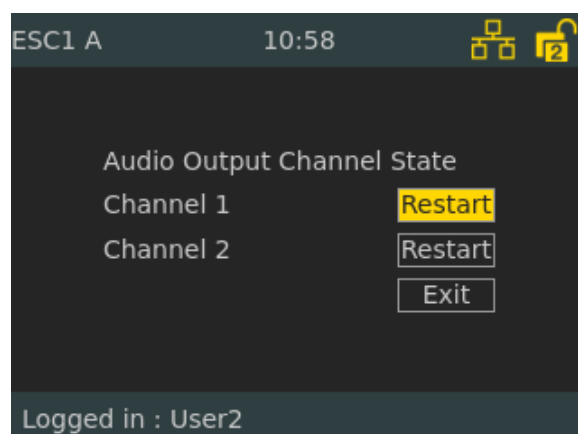

This submenu can be used to restart the audio output channel when an output is shut down due to being overheated or shorted.

A.5.4 Restart & Restore

Access Level = 2

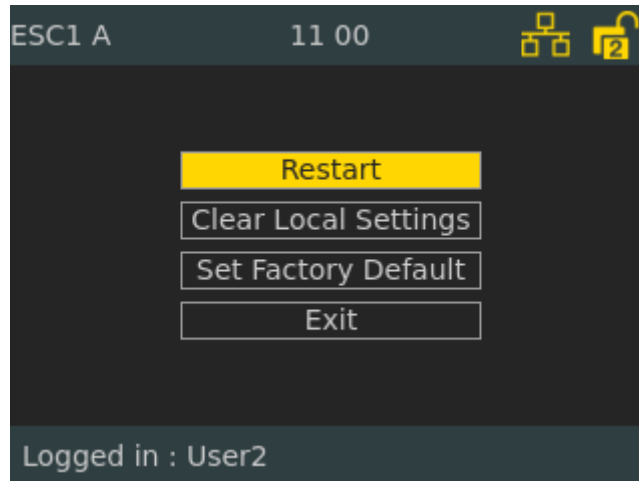

- **Restart:** This will restart all software.
- **Clear Local Settings:** This will remove settings done manually in the system controller such as enable/disable audio output.
- **Set Factory Default:** This will remove all configuration data and set the default configuration. This will not change the IP address.

A.6 Settings

The Settings submenu allows an operator to adjust the most basic settings for the system controller. An operator shall be able to replace the system controller with another one by using these menu options.

A.6.1 General

Access Level = 2

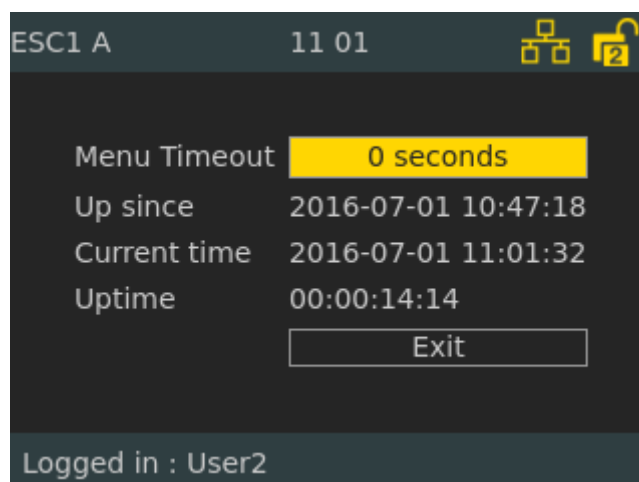

-
- **Menu Timeout:** The system controller will automatically log off and return to the idle screen if there has been no user action for the time specified.
 - Value 0 means no timeout (Will not automatically return to idle screen).
 - Default = 60 seconds.

A.6.2 Audio Output Volume

Access Level = 1

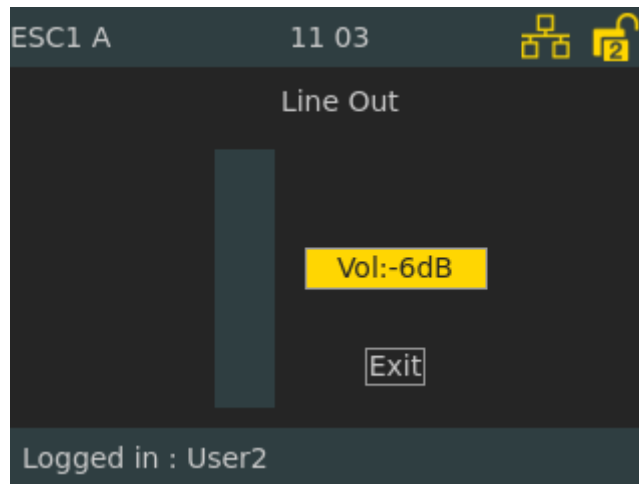

- This submenu changes the volume on the line output.
- Range : -40dB to +2dB.

A.6.3 Audio Input Gain

Access Level = 1

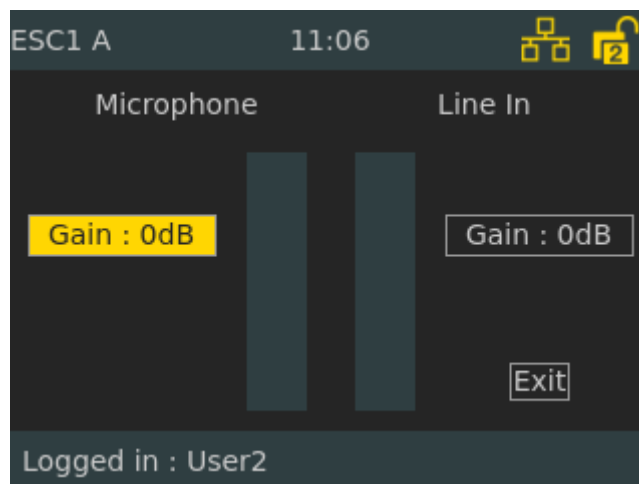

Menu for setting the gain for microphone and line in both the system controller and amplifier.

- Default setting : 0 dB
- Value range : 0 to 47 dB

A.6.4 Display

Access Level = 1

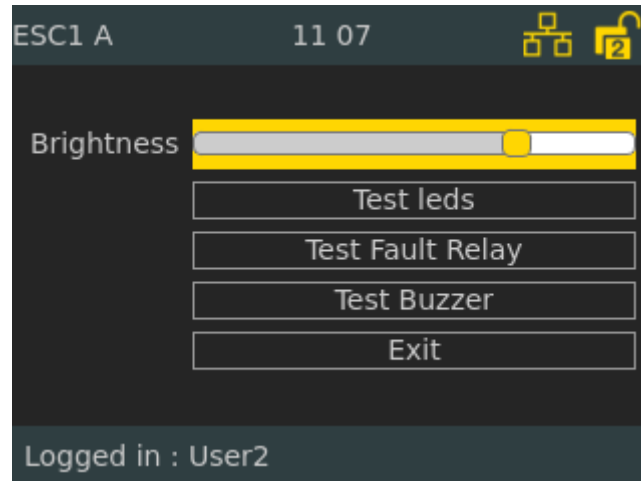

The display settings page is used to set the different parameters for the display.

Brightness : Adjusts the brightness level of the display

Self-test buttons : Toggle relay/LEDs/buzzer at 1 sec off, 5 sec on, 1 sec off, back to normal position.

Test leds : Self-test for LEDs

Test Fault Relay : Self-test for relay

Test Buzzer : Self-test for buzzer

A.7 Information

The information submenu contains information about the system controller and the system.

A.7.1 Device Info

Access Level = 1

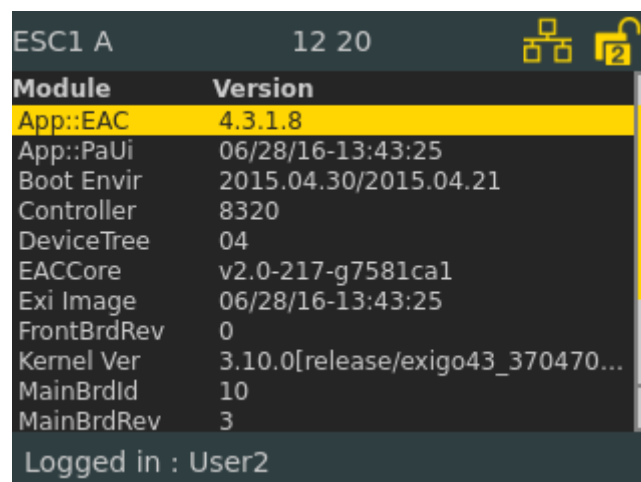

The device information page will show all relevant information about the system controller such as HW board, software packages, Linux kernel, etc.

A.7.2 Network

Access Level = 2

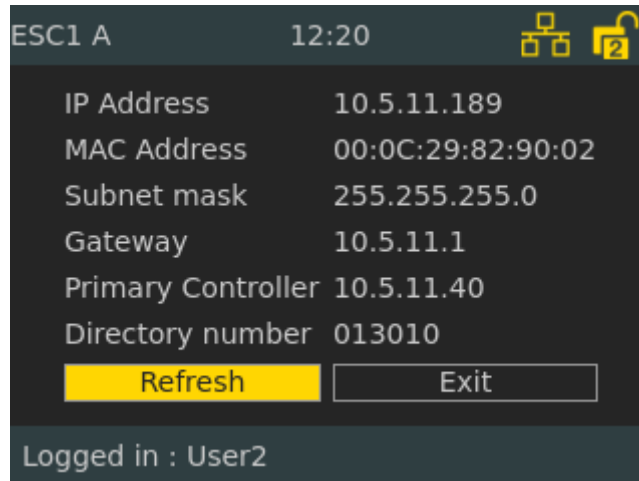







This menu displays network information for the system controller such as IP & MAC addresses, gateway, and directory number.

A.7.3 Attached Devices

Access Level = 1

The attached devices information page will display a list of all devices connected to this system controller.

ESC1 A 14 01   			ESC1 A 14 24   		
Device	IpAddr	Status	Device	IpAddr	Status
ECPIR-3P A1	10.5.11.50	Online	ECPIR-3P A1	10.5.11.50	Online
ENA2200 A1 Backup	10.5.11.44	Online	ENA2200 A1 Backup	10.5.11.44	Online
ENA2200 A2	10.5.11.47	Online	ENA2200 A2	10.5.11.47	Online
ENA2200 A3		Offline	ENA2200 A3		Offline
ESC1 A	10.5.11.41	Online	ESC1 A	10.5.11.41	Online
TKIS-2 A1	10.5.11.49	Online	TKIS-2 A1	10.5.11.49	Online
EAPIR-8 B1	10.5.11.48	Online	EAPIR-8 B1	10.5.11.48	Online
ESC1 B	10.5.11.43	Online	ESC1 B	10.5.11.43	Online
			AlphaCom	10.5.11.46	Offline

This list indicates status for endpoints configured for the controller.

When the device is offline, the IP address is unknown and not shown.

Device : Name of the endpoint/device attached to the ESC system controller

IpAddr : IP Address of the endpoint/device attached to the ESC system controller

Status : Connection status of the endpoint/device attached to the ESC system controller

Offline : Device is registered in ESC but not connected

Online : Device is registered in ESC and connected

Unregistered : Device tries to connect to ESC but the directory number is unknown

A.7.4 Control Input

Access Level = 1

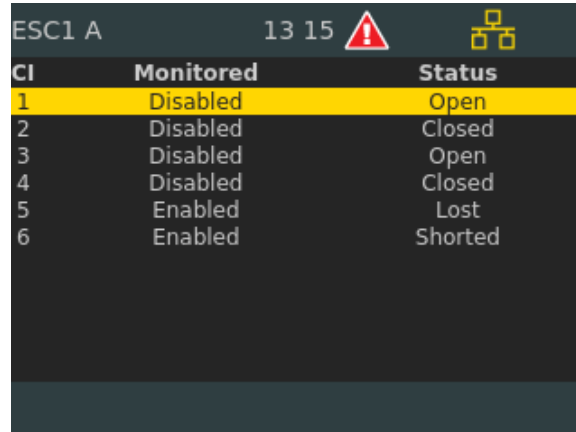

CI	Monitored	Status
1	Disabled	Open
2	Disabled	Closed
3	Disabled	Open
4	Disabled	Closed
5	Enabled	Lost
6	Enabled	Shorted

This menu displays the status of the control input when monitored.

Monitored

When enabled the input is checked whether it is shorted or left unconnected.

Status

Unknown : Unknown state, initial state during startup

Lost : Failure, Line broken (too high input voltage)

Open : OK, Switch/relay is open

Closed : OK, Switch/relay is closed

Shorted : Failure, Line broken (too low input voltage)

Note that status Lost or Shorted will only occur when monitoring of the input is enabled.

A.7.5 Control Output

Access Level = 1

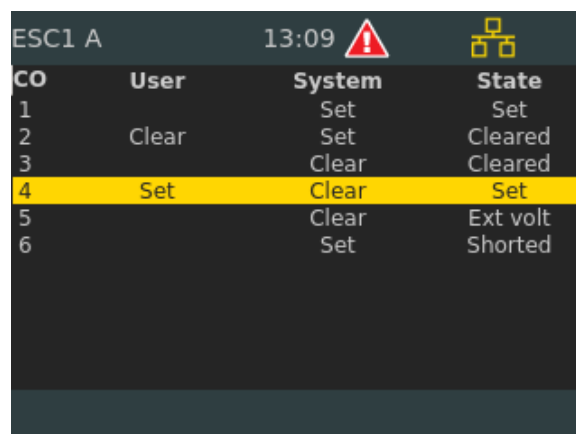

CO	User	System	State
1		Set	Set
2	Clear	Set	Cleared
3		Clear	Cleared
4	Set	Clear	Set
5		Clear	Ext volt
6		Set	Shorted

This menu displays the status of the control output when monitored.

Each Control Output supports both Normal Open (NO) and Normal Closed (NC) connections.

The relation between control output state and the NO and NC position is shown below:

State (Control Output)	NO	NC
Set	Closed	Open
Clear	Open	Closed

User

User has the option to manually control the output state to overrule system control output state.

- Set : Manually "set" (close) the control output
- Clear : Manually "clear" (open) the control output

System

- System calculated state for the control output.
- Set : System will "set" (close) the control output
- Clear : System will "clear" (open) the control output

State

- This is the current state of the physical control output.
- Unknown: Unknown state, initial state during startup
- Cleared : Output relay released - NO:open, NC:closed and 0VDC
- Set : Output relay activated - NO:closed / NC:open and +24VDC
- Shorted : Output relay activated - NO:open / NC:closed and +0VDC
- Ext volt : Output relay released - NO:open, NC:closed and high voltage at VDC

A.7.6 Diagnostic

Access Level = 1

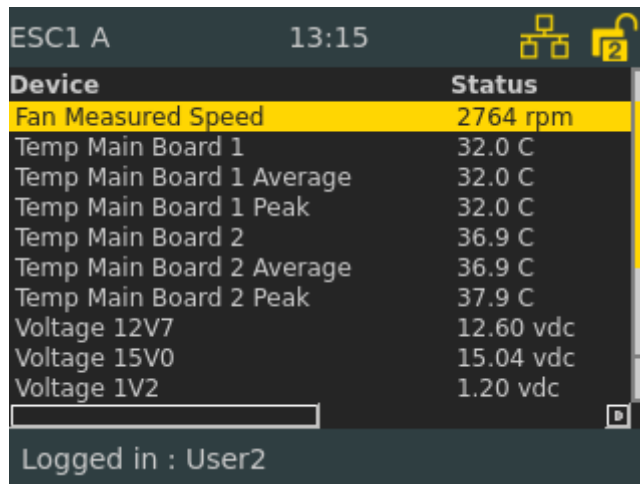

This menu displays the diagnostics of the system controller. The following units are monitored:

- Temperature sensors
- Fan applied effect
- Fan speed sensors
- Fuses
- AC and DC inlet
- Internal power supplies

B Amplifier Menu Structure

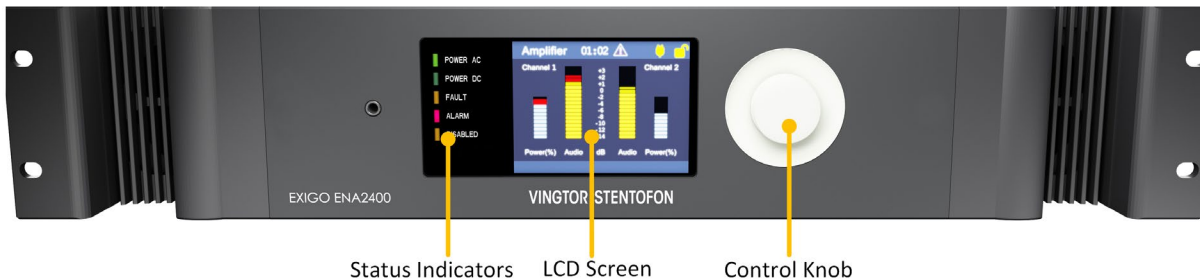

Figure 23: Amplifier Front Panel

The user's means of interaction with the amplifier is through the control knob. The control knob is located next to the LCD screen and can be turned clockwise and counter clockwise, as well as being pressed.

Items in the menu system are selected by turning the control knob:

- Clockwise rotation will move the “selector” to the right or down
- Counter-clockwise rotation will move the “selector” to the left or up

Whether the selector is moved up/down or left/right depends on the current menu displayed:

- Press the control knob to activate the selected menu item
- Press and hold the control knob to return to the previous view

To change or input the parameter values in the selected menu item:

1. Turn the control knob to move between the parameter fields
2. Press the control knob to select the parameter field
 - The field **turns green** to indicate that it is selected and ready for input value
3. Turn the control knob to change the parameter value
4. Press the control knob to select the parameter value

Factory Default with DHCP

To remove all configuration data, set the default configuration and reset to DHCP, press and hold the control knob for 20 seconds while booting up the Amplifier.

B.1 Idle Screen

Audio Output Channel State

- **Disabled** Audio Output Channel is disabled manually or from configuration tool EMT
- **Audio** Audio Output Channel works as expected
- **Unknown** Audio Output Channel state is unknown
- **Refresh** Audio Output Channel is under calibration
- **Shorted** Audio Output Channel is monitored and detected as shorted
- **Open** Audio Output Channel is monitored and detected as open missing speaker load
- **Load Change** Audio Output Channel is monitored and detected change in speaker load

- **Gnd Fault** Audio Output Channel is monitored and detected connection between ground and audio channel signals
- **Shutdown** Audio Output Channel is shut down due to high temperature or extremely high current
- **Low Pilot** Audio Output Channel is monitored and detected low line pilot voltage due to shorted or too high line load
- **Calib failed** Audio Output Channel is configured for monitoring but required calibration failed

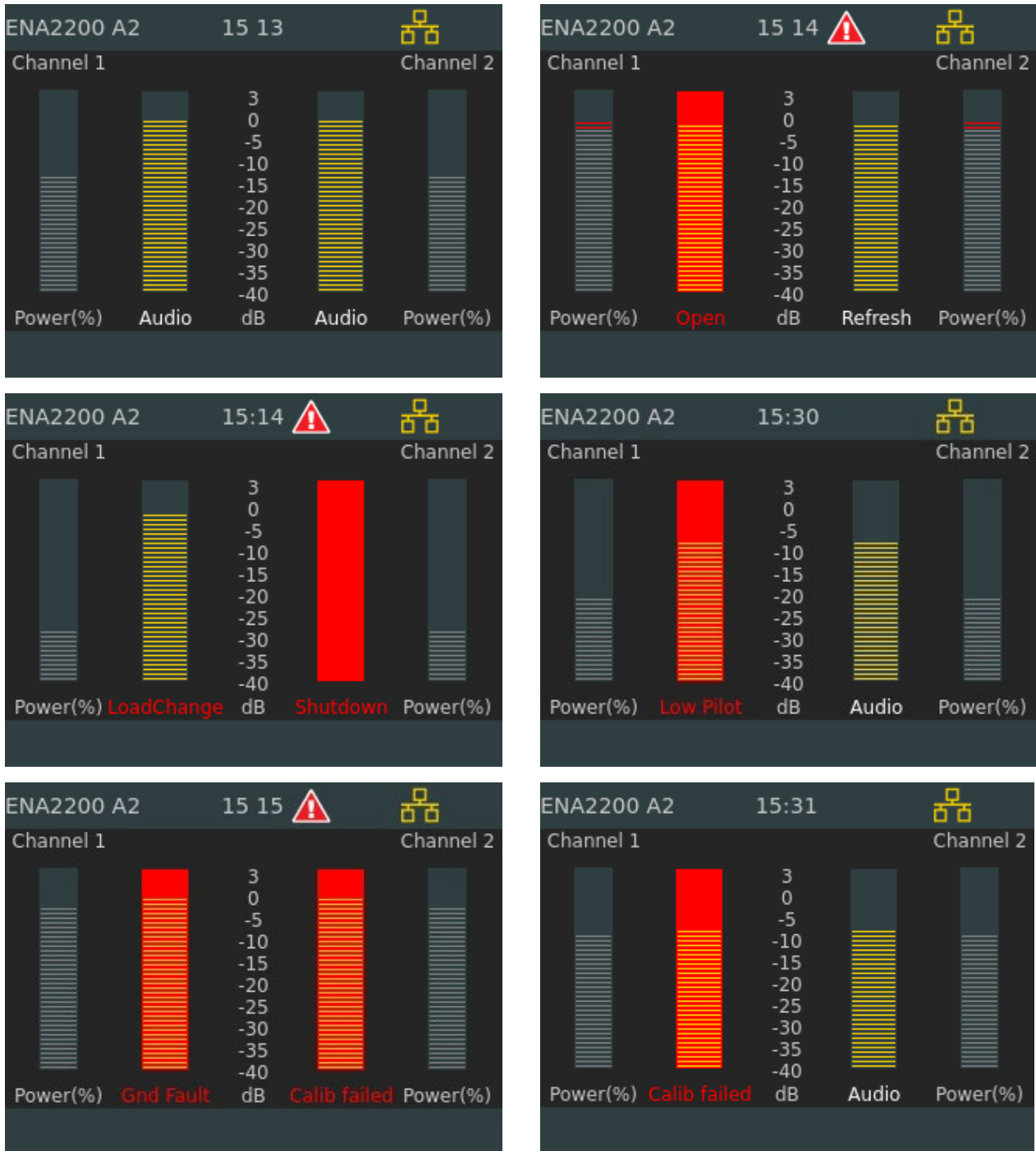
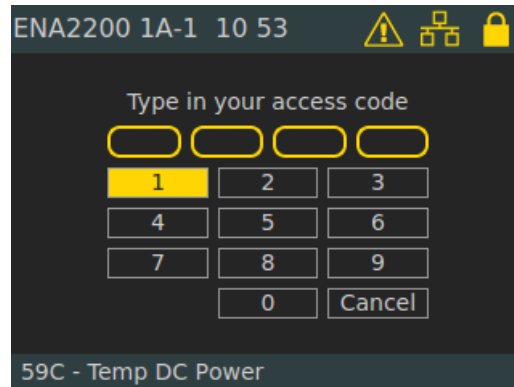

Figure 24: Various Audio Output Channel States

B.2 Access Control

Access control can be implemented using a 4-digit PIN code.



Exigo has two pin code access levels. When logged in the user can see the pin code access level (1 or 2) on the padlock icon at the upper-right corner of the display.

B.3 Amplifier Menu Options

Service

Local Message List: lists all active fault and warning messages for the amplifier

Headphone: selects audio source and adjusts volume of headphone

Tick Tone: selects the tick tone to be used in the particular zone

Audio Output State: restarts the audio output channel when an output is shut down

Restart & Restore: restarts software and restores factory settings

Settings

General: sets menu timeout

Audio Output Monitoring: displays audio output measurement statuses

Audio Output Volume: increases or decreases volume of audio on channels

Audio Input Gain: sets gain for microphone and line

Display: sets display parameters

Information

Device Info: shows information like HW board, software packages, Linux kernel, etc.

Network: displays network information for the amplifier

Attached Devices: list all LETs connected to the amplifier

Control Input: displays status of the control input

Control Output: displays status of the control output

Diagnostic: displays diagnostics of the amplifier

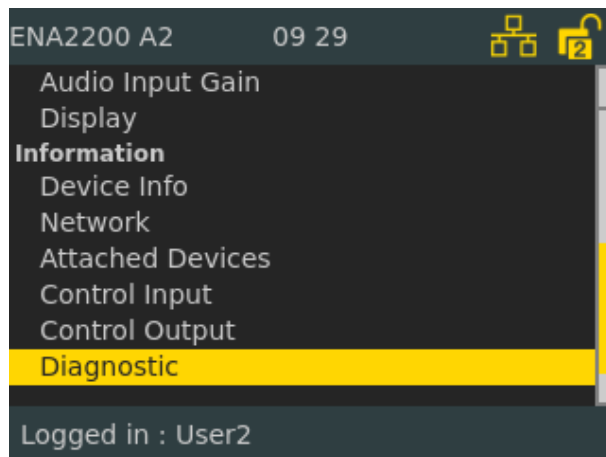
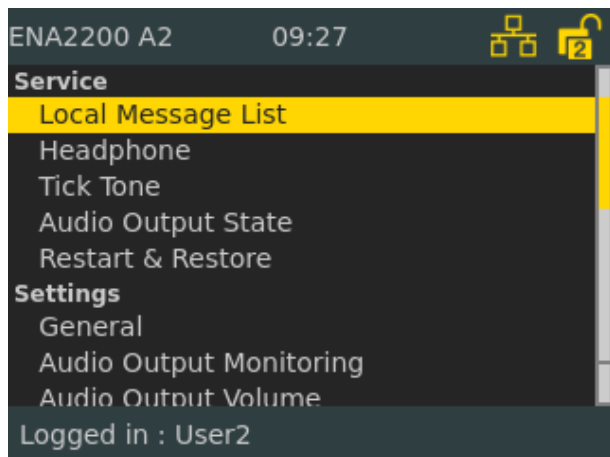

B.4 Service

B.4.1 Local Message List

Access Level = 1

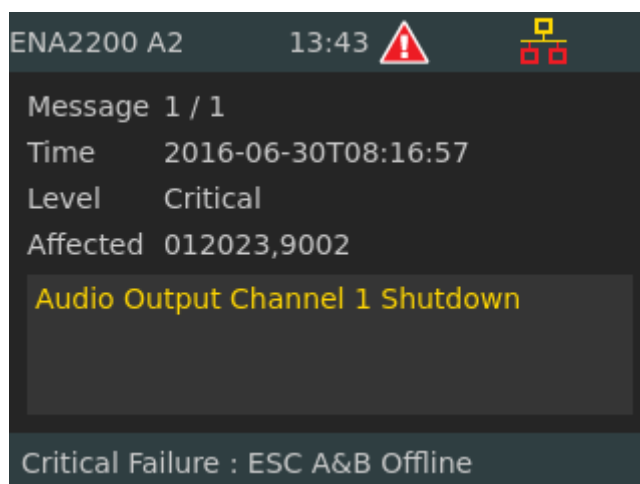

This is a list of all active fault and warning messages for the amplifier.

The message displays relevant information on:

- Time of detection
- Security level
- Zones affected
- Description of the fault

B.4.2 Headphone

Access Level = 1



Defaults

Audio source: None

Volume: 20%

B.4.3 Tick Tone

Access Level = 1

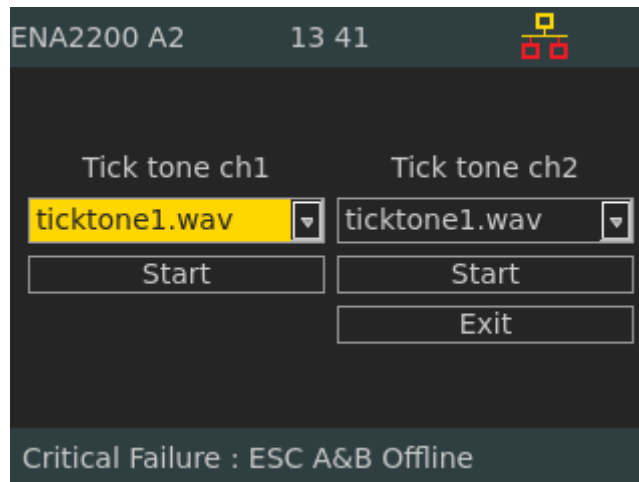

This submenu selects the tick tone to be used in the particular zone.

B.4.4 Audio Output State

Access Level = 1

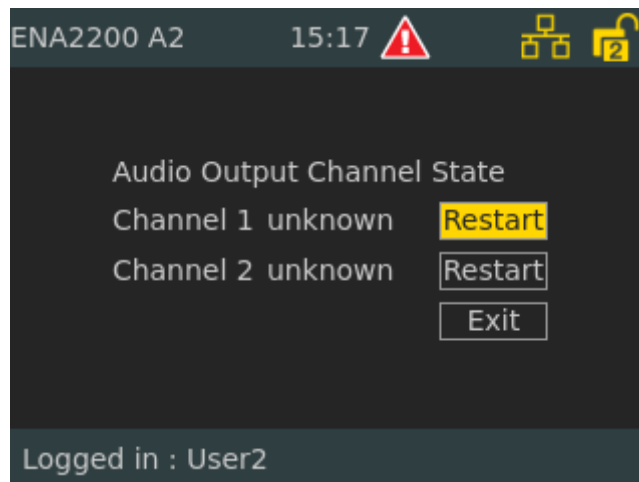

This submenu can be used to restart the audio output channel when an output is shut down due to being overheated or shorted.

B.4.5 Restart & Restore

Access Level = 1

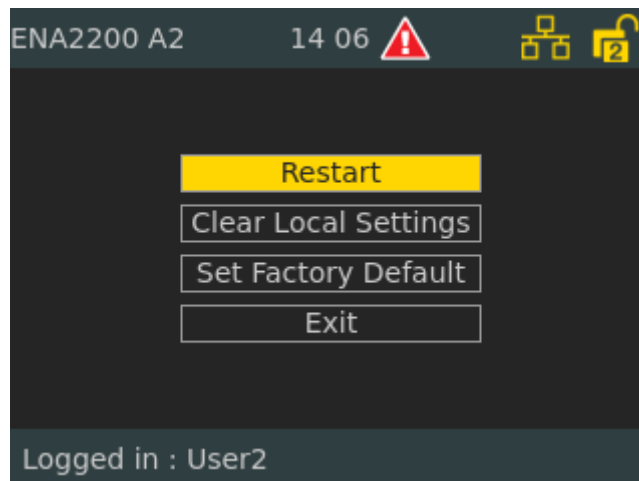

- **Restart:** This will restart all software.
- **Clear Local Settings:** This will remove settings done manually in the system controller such as enable/disable audio output.
- **Set Factory Default:** This will remove all configuration data and set the default configuration. This will not change the IP address.

B.5 Settings

B.5.1 General

Access Level = 2

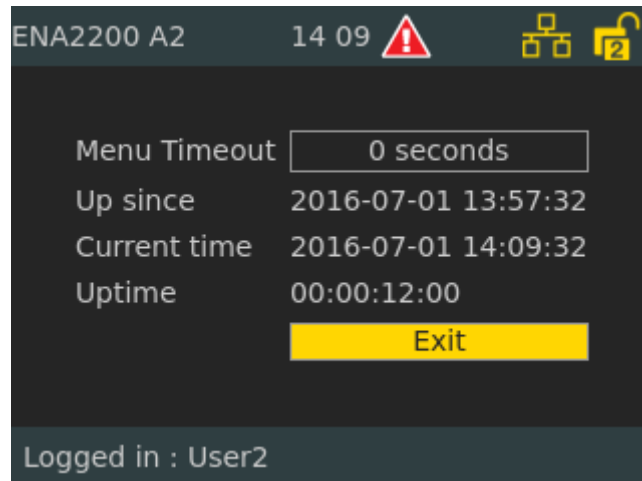

- **Menu Timeout:** The amplifier will automatically log off and return to the idle screen if there has been no user action for the time specified.
- Value 0 means no timeout (Will not automatically return to idle screen).
- Default = 60 seconds.

B.5.2 Audio Output Monitoring

Access Level = 2

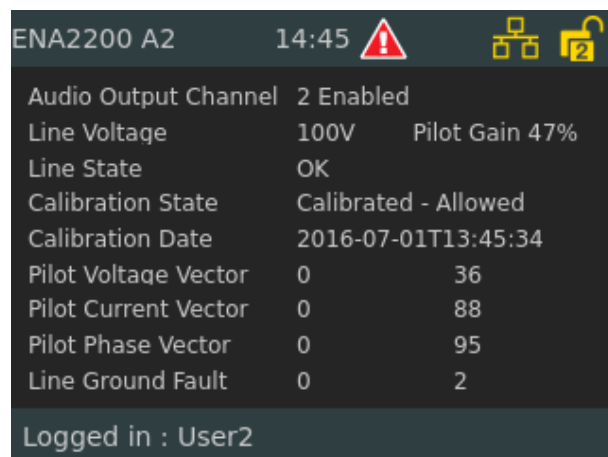
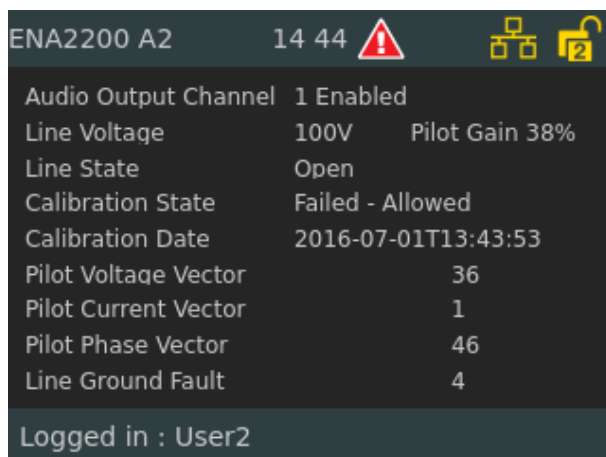

Audio Output Line Measurement Statuses

Audio Output Channel: **Enabled** (Amplifier channel is turned ON) / **Disabled** (Amplifier channel is turned OFF)

Line Voltage: 70V or 100V

Pilot Gain: Value given in % (Range 0..100) - will not be shown when not calibrated.

Line States:

- **OK** : Audio Output Channel is considered OK
- **Unknown** : Audio Output Channel is either Disabled or Uncalibrated
- **Refreshing.....** : Waiting for Audio Output Channel line measurement, typical after initiated Calibration or after enabling a calibrated Audio Output Channel.
- **Line Fault**: When calibrating or on a calibrated Audio Output Channel, the line measurement indicates that the Audio Output Channel is Shorted or Open
- **Load Change** : On a calibrated Audio Output Channel, the line measurement indicates that the Audio Output Channel load has changed
- **Ground Fault** : When calibrating or on a calibrated Audio Output Channel, the line measurement indicates that the Audio Output Channel has a Ground Fault
- **Shutdown** : The Audio Output Channel has been (temporarily) shut down due to internal safety precaution (amplifier has reached "Emergency Shutdown" temperature)
- **Measurement Failed Timeout**: Calibration failed due to internal timeout. Repeat calibration.
- **Measurement Receive Error**: Calibration failed due to communication failure between measurement controller and main controller. Repeat calibration.
- **Low Voltage**: Calibration failed due to heavy load - cannot set Pilot Tone Voltage within acceptable limits.

Line States that indicate one of the following: Shorted, Open, Load Change, Ground Fault, or Shutdown will be displayed as soon as the fault condition is detected. However, the same fault condition must be present for 4 more subsequent measurements (approximately 60 - 75 seconds) before it is reported as a fault.

Calibration State :

- **Uncalibrated**: Audio Output Channel not yet calibrated
- **Calibrating.....**: Calibration is ongoing.
- **Calibrated**: Audio Output Channel calibrated OK.
- **Failed**: Audio Output Channel calibration function failed - see Line State for details.
- **Failed - Low Pilot Tone**: Pilot Tone Voltage used to calibrate Audio Output Channel is too low - not possible to execute a calibration.

Calibration Date: Date for last successful calibration, i.e. 2015-01-06T10:11:12

Pilot Voltage Vector: Typical calibration values for Pilot Tone Voltage Vector (Range 0..100) :: Line State OK: 36, Line State Open: 36, Line State Shorted: 0

Pilot Current Vector: Typical calibration values for Pilot Tone Current Vector (Range 0..100) :: Line State OK 50 ohm load: 79, Line State Open: 0-1, Line State Shorted: 90-99

Pilot Phase Vector: Typical calibration values for Pilot Tone Phase Vector (Range 0..100) :: Line State OK 50 ohm load: 89, Line State Open: 46-50, Line State Shorted: 65-69

Line Ground Fault: Typical calibration values for Ground Fault Tone Vector (Range 0..100) :: Line State OK: 0-5, Line State Ground Fault: > 10

- Press the control knob to enter the submenu with access to:
 - **Cancel**
 - **Disable / Enable** - Audio channel amplifier output
 - **Monitor** - start line impedance check and LET/ELTSI supervision

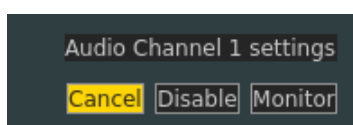

- Select the **Monitor** button to enter the submenu with access to:

-
- **Cancel**
 - **Calibrate** - Start calibration sequence for line impedance measurements. If Calibration succeeds, enabled line and/or LET monitoring will start.
 - **UnCalibrate** - Removes previous line calibration information. Terminates ongoing line and/or LET monitoring.

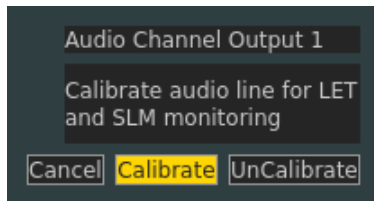

B.5.3 Audio Output Volume

Access Level = 2

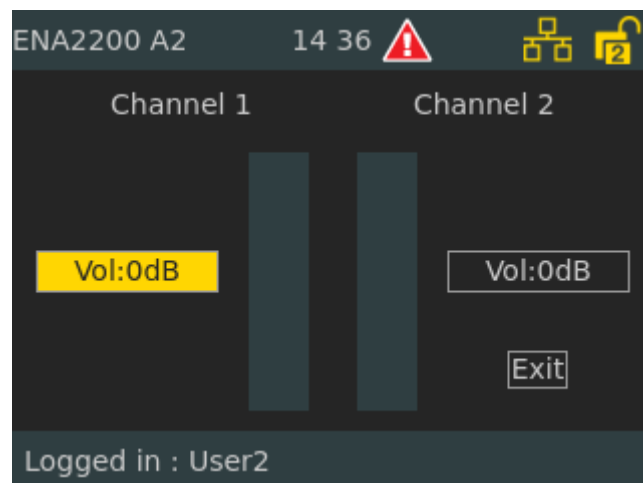

This parameter increases or decreases the volume of the audio on the channels.

B.5.4 Audio Input Gain

Access Level = 2

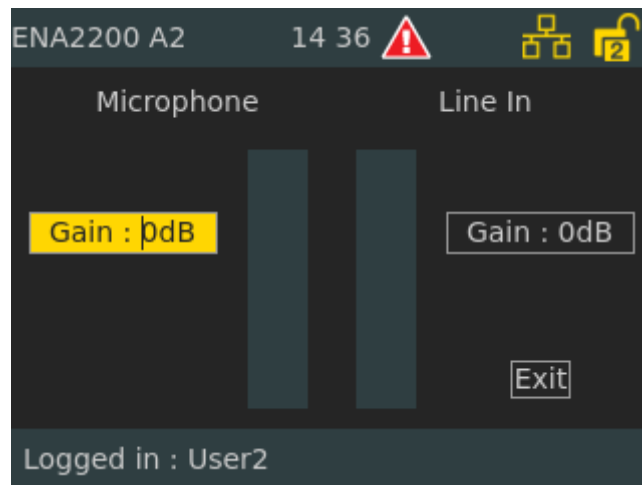

This parameter sets the gain for microphone and line in both the system controller and amplifier.

Default setting : 0 dB

Value range : 0 to 47 dB

B.5.5 Display

Access Level = 1

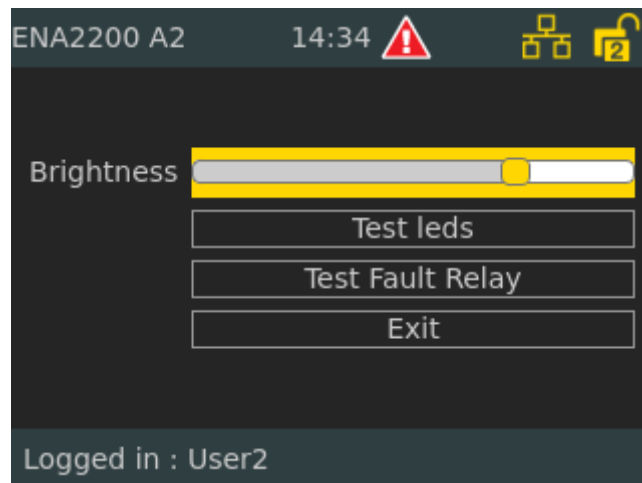

Display Control : Manual (Default)

Brightness : Adjusts the brightness level of the display

Self-test buttons :

This will toggle the relay/LEDs/buzzer in the following sequence: 1 sec off, 5 sec on, 1 sec off and back to normal position.

Test leds : Self-test for LEDs

Test Fault Relay : Self-test for relay

B.6 Information

B.6.1 Device Info

Access Level = 1

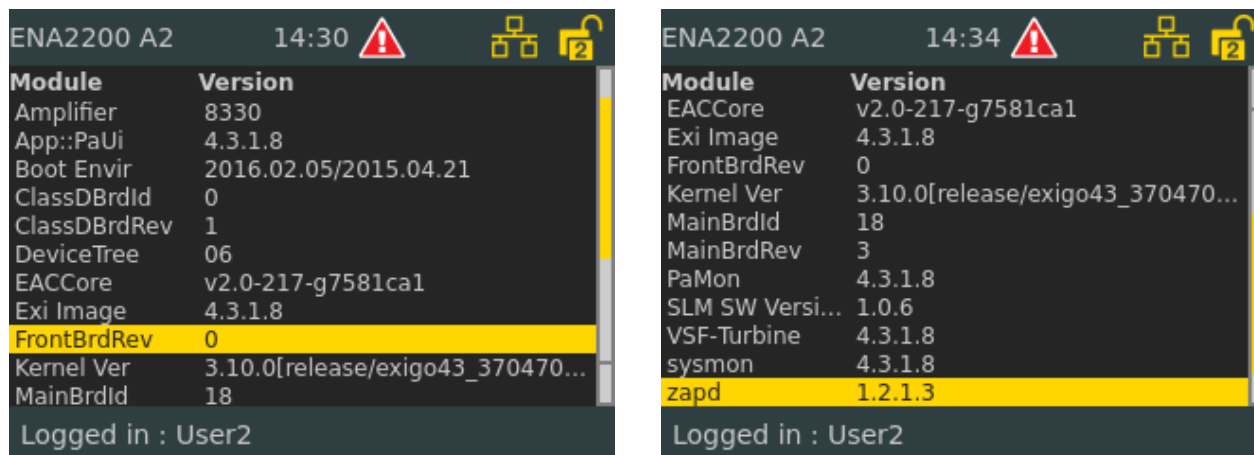

Device Info shows a list of device parameters such as installed software and revisions of the various PCBs.

B.6.2 Network

Access Level = 2

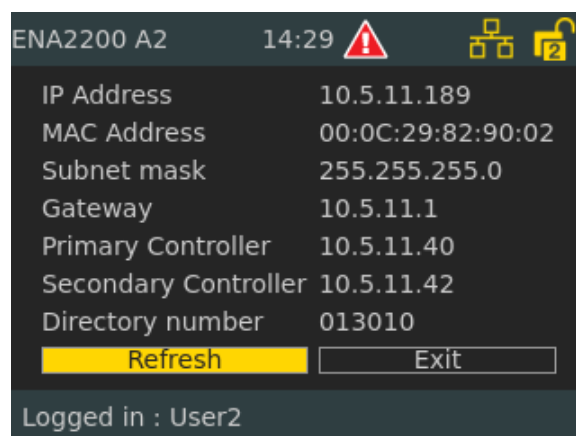

This menu displays network information for the amplifier such as IP & MAC addresses, gateway, and directory number.

B.6.3 Attached Devices

Access Level = 1

Let/ch	Description	SW	HW	Volt	Live
1/1	Open Deck	2.1	0-0	21.9	100
2/1	ECR	2.1	0-0	22.0	100
3/1				0.0	0
4/1	Lifeboats	2.1	0-0	22.2	100
5/1	Crew Cabins	2.1	0-0	22.3	100
6/2	Passengers	2.1	0-0	21.7	100

This parameter lists all connected LETs for each channel.

Let/ch: LET [1 -10] / Channel number [1 - 2]

Description: Description of the LETs

SW: Software version

HW: Hardware version

Volt: Voltage Vector. LET power supply voltage. Normally from 21.0 to 23.0 volts

Live: Indicates in % uptime since last polling. (In suspended mode this value will not be accurate.)

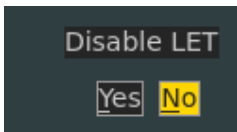

- Press the control knob to enter the submenu to disable/enable LETs
- Select **Yes** to disable the LET

Note that to monitor the LETs, the Audio Output channel for LET monitoring must be enabled in EMT.

B.6.4 Control Input

Access Level = 1

CI	Monitored	Status
1	Enabled	Open
2	Enabled	Lost
3	Enabled	Open
4	Enabled	Closed
5	Enabled	Shorted
6	Disabled	Unknown

32.7C - Temp Main Board

This menu displays the status of the control input when monitored.

Monitoring

When enabled the input is checked whether it is shorted or left unconnected. Configured in EMT.

Status

Unknown : Unknown state, initial state during startup

Lost : Failure, Line broken

Open : OK, Switch/relay is open

Closed : OK, Switch/relay is closed

Shorted : Failure, Line broken

Note that the status Lost or Shorted will only occur when monitoring of the input is enabled.

B.6.5 Control Output

Access Level = 1

CO	User	System	State
1		Set	Set
2		Clear	Cleared
3	Set	Clear	Set
4	Clear	Set	Cleared
5		Set	Overload
6		Clear	Shorted

Logged in : User6

This menu displays the status of the control output when monitored.

Each Control Output supports both Normal Open (NO) and Normal Closed (NC) connections.

The relation between control output state and the NO and NC position is shown below:

State (Control Output)	NO	NC
Set	Closed	Open
Clear	Open	Closed

User

User has the option to manually control the output state to overrule system control output state

Set : Manually "set" (close) the control output

Clear : Manually "clear" (open) the control output

System

System calculated state for the control output

Set : System will "set" (close) the control output

Clear : System will "clear" (open) the control output

State

This is the current state of the physical control output

Unknown: Unknown state, initial state during startup

Open: OK, control output is cleared

Closed: OK, control output is set

Shorted: control output was set, but output is lower than limit

Overload: control output was cleared, but output is higher than limit

B.6.6 Diagnostic

Access Level = 1

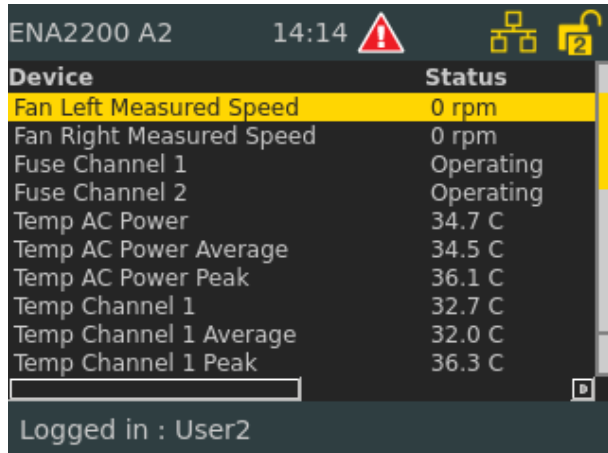

Device	Status
Fan Left Measured Speed	0 rpm
Fan Right Measured Speed	0 rpm
Fuse Channel 1	Operating
Fuse Channel 2	Operating
Temp AC Power	34.7 C
Temp AC Power Average	34.5 C
Temp AC Power Peak	36.1 C
Temp Channel 1	32.7 C
Temp Channel 1 Average	32.0 C
Temp Channel 1 Peak	36.3 C

Logged in : User2

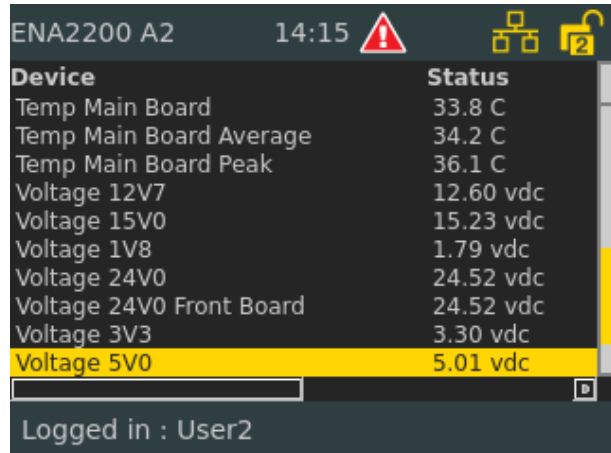

Device	Status
Temp Main Board	33.8 C
Temp Main Board Average	34.2 C
Temp Main Board Peak	36.1 C
Voltage 12V7	12.60 vdc
Voltage 15V0	15.23 vdc
Voltage 1V8	1.79 vdc
Voltage 24V0	24.52 vdc
Voltage 24V0 Front Board	24.52 vdc
Voltage 3V3	3.30 vdc
Voltage 5V0	5.01 vdc

Logged in : User2

This displays the different aspects of the device that are monitored such as:

- Temperature sensors
- Fan applied effect
- Fan speed sensors
- Fuses
- Inlet AC and DC
- Internal power supplies

C Marking & Labeling

Exigo VACIE racks will be labeled as depicted in Figure 25.



Figure 25: Product Label

Certification of the Exigo Voice Alarm Control and Indicating Equipment (Exigo VACIE) is done according to EN 54-16:2008.

D Specifications

These specifications describe the Exigo system that was tested for EN 54-16 compliance.

BASIC DATA		
1	Name of the VACIE	Vingtor-Stentofon Exigo
2	Manufacturer (name, address)	Zenitel Norway AS, Sandakerveien 24C , 0473 Oslo, Norway
3	Built-in hardware (components) the VACIE	ESC1 System Controller ENA2200 Network Amplifier ECPIR-P Exigo Call Panel ECPIR-3P Exigo Call Panel EBMDR-8 Expansion Module EAPII-1 Industrial Access Panel EAPII-6 Industrial Access Panel EMMAI-2H (AK6830) Handheld Microphone MB-30G Gooseneck Microphone Cisco IE-3000-8TC Switch Module Cisco IEM-3000-4PC Expansion Module Protection components: (1) Overvoltage protection for loudspeaker line (100 V): 350V Gas Discharge Tubes type Bourns 2049-35-BLF (2) Overvoltage protection for digital inputs (24 V): 90V Gas Discharge Tubes type Bourns 2049-09-BLF + 58V Tranzorbs type Vishay SMBJ58CA (3) Relay modules for digital outputs (24 V), type SPA-REL (4) AC surge protection type Bourns 1250-2S-230 (5) DC surge protection type Bourns 1320-S-48
4	The kind and the type of devices cooperating with the VACIE	Control and indicating equipment, power supply equipment type PRS-48CH12
5	Type of installation, installation method	One or several racks and emergency microphone cabinets in one room or distributed within the protected premises. - Rack – standing - emergency microphone cabinet – wall mounted
6	Degree of enclosure protection IP of EN 60529	IP-30
7	Range of working conditions [°C]	-5°C to +40°C
8	Cabinet(s) types and dimensions (length x width x height), [m]	Rack type: Rittal DK 5527.120, 0.6 x 0.6 x 1.8 meters Emergency microphone cabinet type: Fibox Arca 403021W, 0.4 x 0.3 x 0.21 meters
9	The VACIE cabinet(s) material	Steel, plastic and glass
10	Applied software version	4.1
11	Additional functions in the VACIE	background music, non-emergency messages
12	Means to limit the consequences of a short circuit or an interruption in the transmission path to the loudspeaker(s) (more information, see section 13.5.2 of EN 54-16)	Each channel in amplifier has short circuit protection.

TRANSMISSION PATHS		
13	Loudspeaker line voltage, [V]	70V, 100 V
14	Recommended cable parameters for each transmission path (in case of shielded cables please indicate how the shield should be terminated – one end or both ends to earth connection):	
	primary power supply	3 x 1.0 mm ²
	secondary power supply	N/A
	loudspeaker lines	2 x 1.0 mm ²
	transmission path to the CIE	8 x 0.25 mm ²
	fault control output lines	8 x 0.25 mm ²
	voice alarm condition output lines	2 x 0.5 mm ²
	transmission path to the emergency microphone	UTP Cat 5e
	connection line between the VACIE cabinets	UTP Cat 5e
	ground connection line	1 x 2.0 mm ²
15	Rated values of fuses, [A]	Mains power supply: C6 Secondary power supply: 40A ESC1: 1 A (primary PS), 4 A (secondary PS) ENA2200: 6.3 A (primary PS), 50 A (secondary PS)
16	Type of control loudspeaker lines	Impedance method
17	The maximum number of voice alarm zones	250
18	The opportunity to simultaneously broadcasting more than 1 messages to more than 1 voice alarm zones	Yes
NETWORK AMPLIFIERS		
19	Type (name) of network amplifiers	ENA2200
20	Network amplifier class	D
21	Output power, [W]	2x200W
22	Minimum resistive load, [Ω]	100V: 50.0 Ω per channel 70V: 25.0 Ω per channel
23	Maximum capacitive load line connected in amplifiers, [μ F]	470 nF
24	Input load simulating the microphone impedance (if provided), [k Ω] (more information see 16.4 EN 54-16)	600 Ω / 10 k Ω (selectable)
TRANSMISSION PATH BETWEEN DISTRIBUTED CABINETS OF THE VACIE		
25	Type of connection	Mixed (star, ring, mesh)
26	Maximum number of cabinets of the VACIE, [unit]	250
27	I/O interface marking (wire connection, fiber optic)	Wire connection (Cat5, 6, 7), interface type Cisco IE-3000-8TC Switch Module, Cisco IEM-3000-4PC Expansion Module
28	Communication standard	Ethernet
29	Maximum permitted length of transmission line, [m]	100 m

TRANSMISSION PATH TO THE CIE		
30	Interface type	Relay or solid-state I/O (24 Vdc)
31	The conditions of cooperation, number of control inputs for CIE outputs, type of protocol, the control of connection	Controller: 6 inputs + 6 outputs + 1 relay Amplifier: 6 inputs + 6 outputs + 1 relay
POWER SUPPLY		
32	Power supply equipment has the certificate of conformity according EN 54-4/A1/A2	Yes, no. 0333-CPD-075383-1
33	Power supply equipment is included in the VACIE	Yes
Primary power supply		
34	Operating voltage, [V AC]	Mains Vnom = 110 – 230 V AC
35	Maximum current consumption during the quiescent condition, [A]	≤ 0.2 A (ESC1), ≤ 0.2 A (ENA2200)
36	Maximum current consumption during the voice alarm condition, [A]	≤ 0.9 A (ESC1), ≤ 4.5 A (ENA2200)
Secondary power supply		
37	Operating voltage, [V DC]	PRS-48CH12 Vnom = 48 V DC
38	Maximum current consumption during the quiescent condition, [A]	≤ 1 A (ESC1), ≤ 1 A (ENA2200)
39	Maximum current consumption during the voice alarm condition, [A]	≤ 2 A (ESC1), ≤ 20 A (ENA2200)
OPTIONS WITH REQUIREMENTS		
40	Manual silencing of the voice alarm condition (7.6.2)	Yes
41	Manual reset of the voice alarm condition (7.7.2)	Yes
42	Voice alarm condition output (7.9)	Yes
44	Indication of faults related to voice alarm zones (8.4)	Yes
45	Disablement condition (9)	Yes
46	Voice alarm manual control (10)	Yes
47	Emergency microphone(s) (12)	Yes

Table 17: Specifications



The WEEE Directive does not legislate that Zenitel, as a 'producer', shall collect 'end of life' WEEE.

This 'end of life' WEEE should be recycled appropriately by the owner who should use proper treatment and recycling measures. It should not be disposed to landfill.

Many electrical items that we throw away can be repaired or recycled. Recycling items helps to save our natural finite resources and also reduces the environmental and health risks associated with sending electrical goods to landfill.



Under the WEEE Regulations, all new electrical goods should now be marked with the crossed-out wheeled bin symbol shown.

Goods are marked with this symbol to show that they were produced after August 13, 2005 and should be disposed of separately from normal household waste so that they can be recycled.